

# DSP Starter Kit (DSK) for the TMS320C6416T (1 GHz)

## Quick Start Installation Guide

### Kit Contents

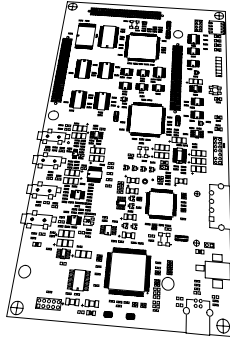

C6416 DSK Board



+5V Universal  
Power Supply

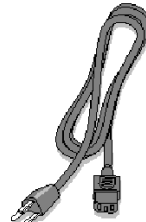

AC Power  
Cord

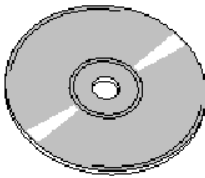

C6416 DSK Code Composer  
Studio CD ROM



TMS320C6416 DSK  
Technical Reference



USB Cable

### System Requirements

- 500MB of free hard disk space
- Microsoft Windows™ 2000/XP
- 128MB of RAM
- 16-bit color display
- CD-ROM Drive

### Service and Support

Web	<a href="http://support.spectrumdigital.com">http://support.spectrumdigital.com</a>
E-Mail	<a href="mailto:support@spectrumdigital.com">support@spectrumdigital.com</a>

### Description

The 6416 DSP Starter Kit (DSK) is an all-in-one evaluation platform for the TMS320C6416T Digital Signal Processor from Texas Instruments. It includes a target board that can be used as a reference design for interfacing the DSP to common devices such as SDRAM, Flash and a codec as well as a special introductory version of TI's flagship Code Composer Studio development tools. An on-board JTAG emulator allows debug from Code Composer Studio through your PC's USB port.

This kit contains everything you need to get started with TI DSPs. It can also be used with the full version of Code Composer Studio and an external JTAG emulator.

## Install DSK Content from the CD-ROM

Before you install the DSK software, please make sure you are using **Administrator privileges** and any **virus checking** software is turned off. The DSK board should **not be plugged in** at this point.

1. Insert the Code Composer Studio installation CD into the CD-ROM Drive. An install menu (see below) should appear. If it does not, manually run Launch.exe from the CD-ROM. Select the **Install Products** option from the menu.

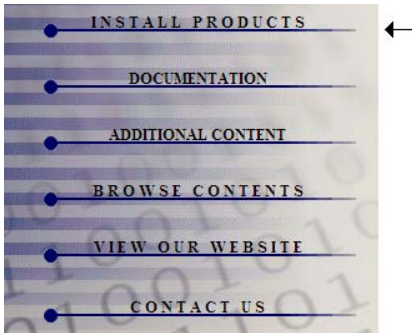

2. Install any components you need. To debug with the DSK you must have 1) a copy of **Code Composer Studio**, 2) the **target content** package for your board and 3) a copy of the **FlashBurn** plug-in.

Users of the full Code Composer Studio package can skip the DSK Code Composer installation and simply install the target content packages.

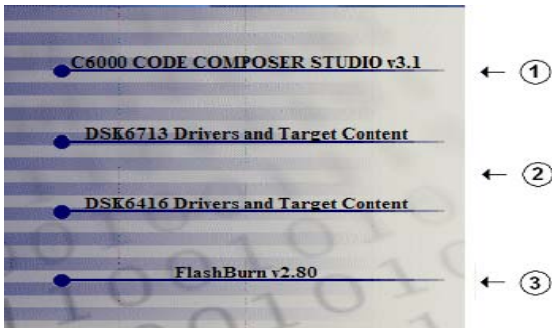

3. The installation procedure will create two icons on your desktop:

6416 DSK CCStudio v3.1  
6416 DSK Diagnostics Utility v3.1

## Connect the DSK to Your PC

1. Connect the supplied USB cable to your PC or laptop. We recommend that anyone making hardware modifications connect through a USB hub for safety.
2. If you plan to connect a microphone, speaker, or expansion card these must be plugged in properly before you connect power to the DSK board.
3. Connect the included 5V power adapter brick to your AC power source using the AC power cord.
4. Apply power to the DSK by connecting the power brick to the 5V input on the DSK.
5. When power is applied to the board the Power On Self Test (POST) will run. LEDs 0-3 will flash. When the POST is complete all LEDs blink on and off then stay on. At this point your DSK is functional and you can now finish the USB driver install.

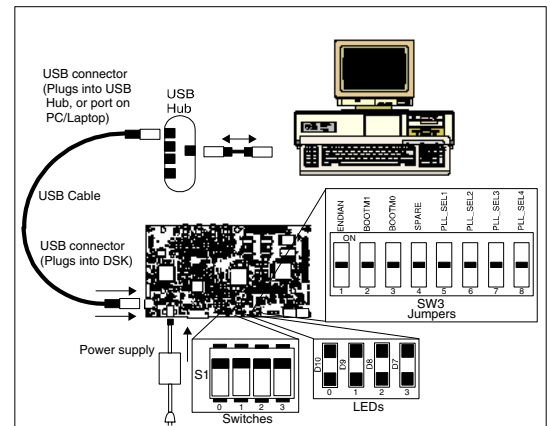

6. Make sure your DSK CD-ROM is installed in your CD-ROM drive. Now connect the DSK to your PC using the included USB. After few seconds Windows will launch its "Add New Hardware Wizard" and prompt for the location of the DSK drivers.
7. Follow the instructions on the screens and let Windows find the USB driver files "dsk6416.inf" and "sdusb2em.sys" on the DSK CD-ROM. On XP systems Windows will find the drivers automatically.

## Testing Your Connection

If you want to test your DSK and USB connection you can launch the C6416 DSK Diagnostic Utility from the icon on your desktop.



From the diagnostic utility, press the start button to run the diagnostics. In approximately 30 seconds all the on-screen test indicators should turn green.

## Starting Code Composer

To start Code Composer Studio, double click the 6416 DSK CCStudio icon on your desktop.



## Running the DSK Tutorial

The on-line help included with the DSK contains in-depth information about the hardware and software that comes with the kit. It also contains a tutorial that will help you get started with your DSK and learn about its features. To access the on-line help and run the tutorial, follow these steps:

1. Start Code Composer Studio (ignore this if CCS is already running) by double-clicking on the C6416 DSK icon on your desktop.
2. Use the **Debug --> Connect** menu option to open a debug connection to the DSK board.
3. Launch the DSK help file by opening the following file using Windows Explorer.

```
C:\CCStudio_v31.\docs\hlp\c6416dsk.hlp
```

4. Look in the section entitled "**Welcome to Your 'C6416 DSK'**". You will find the tutorial and other introductory material there. Note that older versions of CCStudio use c:\ti as the default install path instead of c:\CCStudio\_v31. so you may have to adjust the path names to match the actual location of files on your PC.

## Code Composer Registration

Remember to register your product within 30 days of purchase. Texas Instruments may make available DSK specific patches, utilities or promotions to registered DSK users. You must register your DSK through the online web registration form to enable access through the new Internet enabled Update Advisor. You can register online during installation if you are connected to the Internet. To register online after installation or to register via fax or by e-mail you can access the registration forms from within Code Composer Studio TM IDE. From the menu bar select Help → Register, select the appropriate registration link for your product and follow the instructions on the form.

You will need your Service Code to register the product. The Service Code is a 16 digit number starting with the letters CCS attached to the CD case.

**Note: paid annual software subscription service is not available for DSK products.**

## 6416 DSK Hardware Registration

The 6713 DSK hardware can be registered using the on-line registration process at [www.spectrumdigital.com](http://www.spectrumdigital.com). Spectrum Digital, Inc. warrants the products it produces for one (1) year after the date of purchase. For a product to be considered "in warranty", Spectrum Digital must be notified of the defect within one (1) year after being purchased from Spectrum Digital or one of its authorized resellers. Spectrum Digital is not responsible for accidents, improper installation of connections, misuse, neglect or unauthorized modifications. If the product qualifies for warranty repair Spectrum Digital may repair or replace the product at its discretion.

## Related Documentation

A complete list of related documentation is available in the on-line help. The path to this documentation is (assuming you choose c:\CCStudio\_v3.1 as the default path)

```
c:\CCStudio_v3.1\docs\pdf\release_ccs_full_master.html
```

## Debug Hints and Trouble Shooting

1. If installing on Windows XP and your PC is connected to the internet through a firewall the USB install may take up to 15 minutes if you let it complete normally. The work-around for this issue is to simply disconnect your network cable during the USB hardware install.
2. Make sure all of the Configuration Switches (SW3) are set in the off position. This configures the DSK for the factory default settings of little endian processor mode booting out of the on-board Flash memory.
3. Some of the Help Files are links to Adobe Acrobat PDF files. If you intend to access these files you must have Adobe Acrobat installed on your system.
4. If you want to verify a successful USB driver install, open your device manager by right clicking on the My Computer icon on your desktop and selecting Properties --> HW --> Device Manager. You should see a new class "SD USB Based Debug Tools" and one Spectrum Digital TMS320C6416 DSK installed.
5. The BUSY LED above the USB connector comes on when power is applied to the DSK. Do not launch Code Composer until the LED is off.

The best place to look for DSK troubleshooting and software updates is:

<http://support.spectrumdigital.com>

## Error Messages

Many of the error messages below refer to USB enumeration issues. The following window will appear when launching CCS or the Diagnostic Utility indicating the enumeration status.

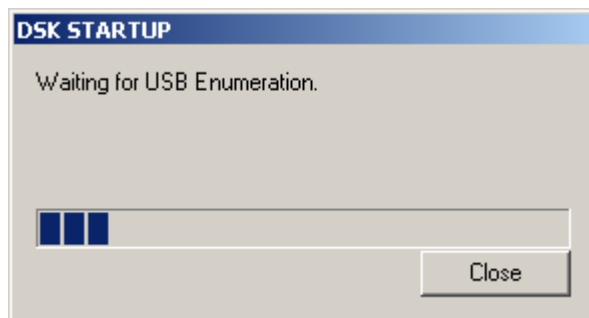

1. Message:  
Failed: Requires Win98, Win2K or Win XP.  
Problem: Your operating system does not support USB.
2. Message:  
Failed: USB device is NOT enumerated or plugged in.  
Problem: Windows cannot find the DSK. Check power and USB Cable.
3. Message:  
Failed: Load USB Application.  
Problem: Loader could not download the DSK emulation application. The on-board emulation controller could be in a bad state. Cycle power on the DSK.
4. Message:  
Failed: USB Channel in use by another app.  
Problem: Another application is using the DSK USB communication channel. Only one application is allowed to communicate to the DSK over the USB channel at the same time. Check for active applications using the Windows Task Manager if open application is not obvious.
5. Message:  
Waiting for USB Enumeration.  
Status: This is a status message which indicates that Code Composer Studio is waiting for communication with the on-board JTAG emulator to be established. This should take less than 10 seconds. Do not hit the close button unless it is clear that something is wrong (the progress bar runs forever).