

TMS320C6000 Chip Support Library API Reference Guide

Literature Number SPRU401J
August 2004



Printed on Recycled Paper

IMPORTANT NOTICE

Texas Instruments Incorporated and its subsidiaries (TI) reserve the right to make corrections, modifications, enhancements, improvements, and other changes to its products and services at any time and to discontinue any product or service without notice. Customers should obtain the latest relevant information before placing orders and should verify that such information is current and complete. All products are sold subject to TI's terms and conditions of sale supplied at the time of order acknowledgment.

TI warrants performance of its hardware products to the specifications applicable at the time of sale in accordance with TI's standard warranty. Testing and other quality control techniques are used to the extent TI deems necessary to support this warranty. Except where mandated by government requirements, testing of all parameters of each product is not necessarily performed.

TI assumes no liability for applications assistance or customer product design. Customers are responsible for their products and applications using TI components. To minimize the risks associated with customer products and applications, customers should provide adequate design and operating safeguards.

TI does not warrant or represent that any license, either express or implied, is granted under any TI patent right, copyright, mask work right, or other TI intellectual property right relating to any combination, machine, or process in which TI products or services are used. Information published by TI regarding third-party products or services does not constitute a license from TI to use such products or services or a warranty or endorsement thereof. Use of such information may require a license from a third party under the patents or other intellectual property of the third party, or a license from TI under the patents or other intellectual property of TI.

Reproduction of information in TI data books or data sheets is permissible only if reproduction is without alteration and is accompanied by all associated warranties, conditions, limitations, and notices. Reproduction of this information with alteration is an unfair and deceptive business practice. TI is not responsible or liable for such altered documentation.

Resale of TI products or services with statements different from or beyond the parameters stated by TI for that product or service voids all express and any implied warranties for the associated TI product or service and is an unfair and deceptive business practice. TI is not responsible or liable for any such statements.

Following are URLs where you can obtain information on other Texas Instruments products and application solutions:

Products		Applications	
Amplifiers	amplifier.ti.com	Audio	www.ti.com/audio
Data Converters	dataconverter.ti.com	Automotive	www.ti.com/automotive
DSP	dsp.ti.com	Broadband	www.ti.com/broadband
Interface	interface.ti.com	Digital Control	www.ti.com/digitalcontrol
Logic	logic.ti.com	Military	www.ti.com/military
Power Mgmt	power.ti.com	Optical Networking	www.ti.com/opticalnetwork
Microcontrollers	microcontroller.ti.com	Security	www.ti.com/security
		Telephony	www.ti.com/telephony
		Video & Imaging	www.ti.com/video
		Wireless	www.ti.com/wireless

Mailing Address: Texas Instruments
Post Office Box 655303 Dallas, Texas 75265

Copyright © 2004, Texas Instruments Incorporated

Read This First

About This Manual

The TMS320C6000™ Chip Support Library (CSL) is a set of application programming interfaces (APIs) used to configure and control all on-chip peripherals. It is intended to make it easier for developers by eliminating much of the tedious work usually needed to get algorithms up and running in a real system.

Some of the advantages offered by the CSL include: peripheral ease of use, a level of compatibility between devices, shortened development time, portability, and standardization. A version of the CSL is available for all TMS320C6000™ devices.

This document is organized as follows:

- Introduction – a high level overview of the CSL
- 27 CSL API module chapters
- HAL macro chapter
- Using CSL APIs Without DSP/BIOS
- Register description
- How to Use the CSL
- Cache register comparison
- Glossary

How to Use This Manual

The information in this document describes the contents of the TMS320C6000™ chip support library (CSL) as follows:

- Chapter 1 provides an overview of the CSL, includes a table showing CSL API module support for various C6000 devices, and lists the API modules.

- Each additional chapter discusses an individual CSL API module and provides:
 - A description of the API module
 - A table showing the APIs within the module and a page reference for more specific information
 - A table showing the macros within the module and a page reference for more specific information
 - A module API Reference section in alphabetical order listing the CSL API functions, enumerations, type definitions, structures, constants, and global variables. Examples are given to show how these elements are used.
- Chapter 28 describes the hardware abstraction layer (HAL) and provides a HAL macro reference section.
- Appendix A provides an example of using CSL independently of DSP/BIOS.
- Appendix B provides a list of the registers associated with current TMS320C6000 DSP devices.
- Appendix C provides a comparison of the old and new CACHE register names, as they have recently been changed.
- Appendix D provides a glossary.

Notational Conventions

This document uses the following conventions:

- Program listings, program examples, and interactive displays are shown in a `special typeface`.
- In syntax descriptions, the function or macro appears in a **bold typeface** and the parameters appear in plainface within parentheses. Portions of a syntax that are in **bold** should be entered as shown; portions of a syntax that are within parentheses describe the type of information that should be entered.
- Macro names are written in uppercase text; function names are written in lowercase.
- TMS320C6000 devices are referred to throughout this reference guide as C6201, C6202, etc.

Related Documentation From Texas Instruments

The following books describe the TMS320C6000 devices and related support tools. To obtain a copy of any of these TI documents, call the Texas Instruments Literature Response Center at (800) 477-8924. When ordering, please identify the book by its title and literature number. Many of these documents can be found on the Internet at <http://www.ti.com>.

TMS320C62x/C67x Technical Brief (literature number SPRU197) gives an introduction to the C62x/C67x digital signal processors, development tools, and third-party support.

TMS320C6000 CPU and Instruction Set Reference Guide (literature number SPRU189) describes the TMS320C6000™ CPU architecture, instruction set, pipeline, and interrupts for these digital signal processors.

TMS320C6x C Source Debugger User's Guide (literature number SPRU188) tells you how to invoke the TMS320C6x™ simulator and emulator versions of the C source debugger interface. This book discusses various aspects of the debugger, including command entry, code execution, data management, breakpoints, profiling, and analysis.

TMS320C6000 DSP Peripherals Overview Reference Guide (literature number SPRU190) describes the peripherals available on the C6000 platform of devices.

TMS320C6000 Programmer's Guide (literature number SPRU198) describes ways to optimize C and assembly code for the TMS320C6000™ DSPs and includes application program examples.

TMS320C6000 Assembly Language Tools User's Guide (literature number SPRU186) describes the assembly language tools (assembler, linker, and other tools used to develop assembly language code), assembler directives, macros, common object file format, and symbolic debugging directives for the TMS320C6000™ generation of devices.

TMS320C6000 Optimizing Compiler User's Guide (literature number SPRU187) describes the TMS320C6000™ C compiler and the assembly optimizer. This C compiler accepts ANSI standard C source code and produces assembly language source code for the TMS320C6000 generation of devices. The assembly optimizer helps you optimize your assembly code.

TMS320C62x DSP Library (literature number SPRU402) describes the 32 high-level, C-callable, optimized DSP functions for general signal processing, math, and vector operations.

TMS320C64x Technical Overview (SPRU395) The TMS320C64x technical overview gives an introduction to the TMS320C64x™ digital signal processor, and discusses the application areas that are enhanced by the TMS320C64x VelociTI™.

TMS320C62x Image/Video Processing Library (literature number SPRU400) describes the optimized image/video processing functions including many C-callable, assembly-optimized, general-purpose image/video processing routines.

TMS320C6000 DSP External Memory Interface (EMIF) Reference Guide (literature number SPRU266) describes the operation of the external memory interface (EMIF) in the digital signal processors of the TMS320C6000 DSP family.

TMS320C6000 DSP Enhanced Direct Memory Access (EDMA) Controller Reference Guide (literature number SPRU234) describes the operation of the EDMA controller in the digital signal processors of the TMS320C6000 DSP family. This document also describes the quick DMA (QDMA) used for fast data requests by the CPU.

TMS320C6000 DSP EMAC/MDIO Module Reference Guide (literature number SPRU628) describes the EMAC and MDIO module in the digital signal processors of the TMS320C6000 DSP family.

TMS320C6000 DSP General-Purpose Input/Output (GPIO) Reference Guide (literature number SPRU584) describes the general-purpose input/output (GPIO) peripheral in the digital signal processors (DSPs) of the TMS320C6000 DSP family.

TMS320C6000 DSP Host Port Interface (HPI) Reference Guide (literature number SPRU578) describes the host-port interface (HPI) in the digital signal processors (DSPs) of the TMS320C6000 DSP family that external processors use to access the memory space.

TMS320C6000 DSP Interrupt Selector Reference Guide (literature number SPRU646) describes the interrupt selector, interrupt selector registers, and the available interrupts in the digital signal processors (DSPs) of the TMS320C6000 DSP family.

TMS320C6000 DSP Inter-Integrated Circuit (I2C) Module Reference Guide (literature number SPRU175) describes the I2C module that provides an interface between a TMS320C6000 digital signal processor (DSP) and any I2C-bus-compatible device that connects by way of an I2C bus.

TMS320C6000 DSP Multichannel Audio Serial Port (McASP) Reference Guide (literature number SPRU041) describes the multichannel audio serial port (McASP) in the digital signal processors (DSPs) of the TMS320C6000 DSP family.

TMS320C6000 DSP Multichannel Buffered Serial Port (McBSP) Reference Guide (literature number SPRU580) describes the operation of the multichannel buffered serial port (McBSP) in the digital signal processors (DSPs) of the TMS320C6000 DSP family.

TMS320C6000 DSP Peripheral Component Interconnect (PCI) Reference Guide (literature number SPRU581) describes the peripheral component interconnect (PCI) port in the digital signal processors (DSPs) of the TMS320C6000 DSP family. The PCI port supports connection of the DSP to a PCI host via the integrated PCI master/slave bus interface.

TMS320C6000 DSP Software Programmable Phase-Locked Loop (PLL) Controller RG (literature number SPRU233) describes the operation of the software-programmable phase-locked loop (PLL) controller in the digital signal processors (DSPs) of the TMS320C6000 DSP family.

TMS320C6000 DSP 32-Bit Timer Reference Guide (literature number SPRU582) describes the 32-bit timer in the TMS320C6000 DSP family.

TMS320C64x DSP Turbo-Decoder Coprocessor (TCP) Reference Guide (literature number SPRU534) describes the operation and programming of the turbo decoder coprocessor (TCP) embedded in the TMS320C6416 digital signal processor (DSP) of the TMS320C6000 DSP family.

TMS320C64x DSP Viterbi-Decoder Coprocessor (VCP) Reference Guide (literature number SPRU533) describes the operation and programming of the Viterbi-decoder coprocessor (VCP) embedded in the TMS320C6416 digital signal processor (DSP) of the TMS320C6000 DSP family.

TMS320C64x DSP Video Port/ VCXO Interpolated Control (VIC) Port Reference Guide (literature number SPRU629) describes the video port and VCXO interpolated control (VIC) port in the TMS320C64x digital signal processors (DSPs) of the TMS320C6000 DSP family.

TMS320C64x DSP Universal Test and Operations Interface for ATM (UTOPIA) Reference Guide (literature number SPRU583) describes the universal test and operations PHY interface for asynchronous transfer mode (UTOPIA) in the TMS320C64x digital signal processors (DSPs) of the TMS320C6000 DSP family.

TMS320C62x DSP Expansion Bus (XBUS) Reference Guide (literature number SPRU579) describes the expansion bus (XBUS) used by the CPU to access off-chip peripherals, FIFOs, and peripheral component interconnect (PCI) interface devices in the TMS320C62x digital signal processors (DSPs) of the TMS320C6000 DSP family.

TMS320C620x/C670x DSP Program and Data Memory Controller/DMA Controller Reference Guide (literature number SPRU577) describes the program memory modes, program and data memory organizations, and the program and data memory controller in the TMS320C620x/C670x digital signal processors (DSPs) of the TMS320C6000 DSP family.

Trademarks

The Texas Instruments logo and Texas Instruments are registered trademarks of Texas Instruments. Trademarks of Texas Instruments include: TI, Code Composer Studio, DSP/BIOS, and TMS320C6000.

All other brand or product names are trademarks or registered trademarks of their respective companies or organizations.

Contents

1	CSL Overview	1-1
	<i>Provides an overview of the chip support library (CSL), shows which TMS320C6000 devices support the various APIs, and lists each of the API modules.</i>	
1.1	CSL Introduction	1-2
1.1.1	Benefits of the CSL	1-2
1.1.2	CSL Architecture	1-2
1.1.3	Interdependencies	1-4
1.2	CSL Naming Conventions	1-5
1.3	CSL Data Types	1-6
1.4	CSL Functions	1-7
1.4.1	Peripheral Initialization via Registers	1-8
1.5	CSL Macros	1-9
1.6	CSL Symbolic Constant Values	1-12
1.7	Resource Management	1-13
1.7.1	Using CSL Handles	1-13
1.8	CSL API Module Support	1-15
1.8.1	CSL Endianess/Device Support Library	1-17
2	CACHE Module	2-1
	<i>Describes the CACHE module, gives a description of the two CACHE architectures, lists the functions and macros within the module, and provides a CACHE API reference section. . . .</i>	
2.1	Overview	2-2
2.2	Macros	2-4
2.3	Functions	2-6
3	CHIP Module	3-1
	<i>Describes the CHIP module, lists the API functions and macros within the CHIP module, and provides a CHIP API reference section.</i>	
3.1	Overview	3-2
3.2	Macros	3-3
3.3	Functions	3-4
4	CSL Module	4-1
	<i>Describes the CSL module, shows the single API function within the module, and provides a CSL API reference section.</i>	
4.1	Overview	4-2

4.2	Functions	4-3
5	DAT Module	5-1
	<i>Describes the DAT module, lists the API functions within the module, discusses how the module manages the DMA/EDMA peripheral, and provides a DAT API reference section.</i>	
5.1	Overview	5-2
5.1.1	DAT Routines	5-2
5.1.2	DAT Macros	5-3
5.1.3	DMA/EDMA Management	5-3
5.1.4	Devices With DMA	5-3
5.1.5	Devices With EDMA	5-3
5.2	Functions	5-4
6	DMA Module	6-1
	<i>Describes the DMA module, lists the API functions and macros within the module, and provides a DMA API reference section.</i>	
6.1	Overview	6-2
6.1.1	Using a DMA Channel	6-4
6.2	Macros	6-5
6.3	Configuration Structures	6-7
6.4	Functions	6-9
6.4.1	Primary Functions	6-9
6.4.2	DMA Global Register Functions	6-14
6.4.3	DMA Auxiliary Functions, Constants, and Macros	6-23
7	EDMA Module	7-1
	<i>Describes the EDMA module, lists the API functions and macros within the module, discusses how to use an EDMA channel, and provides an EDMA reference section.</i>	
7.1	Overview	7-2
7.1.1	Using an EDMA Channel	7-4
7.2	Macros	7-5
7.3	Configuration Structure	7-7
7.4	Functions	7-8
7.4.1	EDMA Primary Functions	7-8
7.4.2	EDMA Auxiliary Functions and Constants	7-16
8	EMAC Module	8-1
	<i>Describes the EMAC module, lists the API functions and macros within the module, and provides an EMAC reference section.</i>	
8.1	Overview	8-2
8.2	Macros	8-4
8.3	Configuration Structure	8-6
8.4	Functions	8-13
9	EMIF Module	9-1
	<i>Describes the EMIF module, lists the API functions and macros within the module, and provides an EMIF API reference section.</i>	
9.1	Overview	9-2

9.2	Macros	9-3
9.3	Configuration Structure	9-5
9.4	Functions	9-6
10	EMIFA/EMIFB Modules	10-1
	<i>Describes the EMIFA and EMIFB modules, lists the API functions and macros within the modules, and provides an API reference section.</i>	
10.1	Overview	10-2
10.2	Macros	10-3
10.3	Configuration Structure	10-5
10.4	Functions	10-7
11	GPIO Module	11-1
	<i>Describes the GPIO module, lists the API functions and macros within the module, and provides a GPIO API reference section.</i>	
11.1	Overview	11-2
	11.1.1 Using GPIO	11-4
11.2	Macros	11-5
11.3	Configuration Structure	11-7
11.4	Functions	11-8
	11.4.1 Primary GPIO Functions	11-8
	11.4.2 Auxiliary GPIO Functions and Constants	11-11
12	HPI Module	12-1
	<i>Describes the HPI module, lists the API functions and macros within the module, and provides an HPI API reference section.</i>	
12.1	Overview	12-2
12.2	Macros	12-3
12.3	Functions	12-5
13	I2C Module	13-1
	<i>Describes the I2C module, lists the API functions and macros within the module, and provides an I2C API reference section.</i>	
13.1	Overview	13-2
	13.1.1 Using an I2C Device	13-3
13.2	Macros	13-5
13.3	Configuration Structure	13-7
13.4	Functions	13-8
	13.4.1 Primary Functions	13-8
	13.4.2 Auxiliary Functions and Constants	13-13
	13.4.3 Auxiliary Functions Defined for C6410, C6413 and C6418	13-22
14	IRQ Module	14-1
	<i>Describes the IRQ module, lists the API functions and macros within the module, and provides an IRQ API reference section.</i>	
14.1	Overview	14-2

14.2	Macros	14-4
14.3	Configuration Structure	14-6
14.4	Functions	14-9
14.4.1	Primary IRQ Functions	14-9
14.4.2	Auxiliary IRQ Functions and Constants	14-15
15	McASP Module	15-1
	<i>Describes the McASP module, lists the API functions and macros within the module, discusses using a McASP device, and provides a McASP API reference section.</i>	
15.1	Overview	15-2
15.1.1	Using a McASP Device	15-4
15.2	Macros	15-5
15.3	Configuration Structure	15-7
15.4	Functions	15-10
15.4.1	Primary Functions	15-10
15.4.2	Parameters and Constants	15-14
15.4.3	Auxiliary Functions	15-17
15.4.4	Interrupt Control Functions	15-30
16	McBSP Module	16-1
	<i>Describes the McBSP module, lists the API functions and macros within the module, and provides a McBSP API reference section.</i>	
16.1	Overview	16-2
16.1.1	Using a McBSP Port	16-4
16.2	Macros	16-5
16.3	Configuration Structure	16-7
16.4	Functions	16-9
16.4.1	Primary Functions	16-9
16.4.2	Auxiliary Functions and Constants	16-15
16.4.3	Interrupt Control Functions	16-23
17	MDIO Module	17-1
	<i>Describes the MDIO module, lists the API functions and macros within the module, and provides an MDIO reference section.</i>	
17.1	Overview	17-2
17.2	Macros	17-3
17.3	Functions	17-4
18	PCI Module	18-1
	<i>Describes the PCI module, lists the API functions and macros within the module, discusses the three application domains, and provides a PCI API reference section.</i>	
18.1	Overview	18-2
18.2	Macros	18-4
18.3	Configuration Structure	18-6

18.4	Functions	18-7
19	PLL Module	19-1
	<i>Describes the PLL module, lists the API functions and macros within the module, discusses the three application domains, and provides a PLL API reference section.</i>	
19.1.1	Using the PLL Controller	19-3
19.2	Macros	19-4
19.3	Configuration Structures	19-6
19.4	Functions	19-7
20	PWR Module	20-1
	<i>Describes the PWR module, lists the API functions and macros within the module, and provides a PWR API reference section.</i>	
20.1	Overview	20-2
20.2	Macros	20-3
20.3	Configuration Structure	20-5
20.4	Functions	20-6
21	TCP Module	21-1
	<i>Describes the TCP module, lists the API functions and macros within the module, discusses how to use the TPC, and provides a TCP API reference section.</i>	
21.1	Overview	21-2
21.1.1	Using the TCP	21-5
21.2	Macros	21-6
21.3	Configuration Structures	21-8
21.4	Functions	21-13
22	TIMER Module	22-1
	<i>Describes the TIMER module, lists the API functions and macros within the module, discusses how to use a TIMER device, and provides a TIMER API reference section.</i>	
22.1	Overview	22-2
22.1.1	Using a TIMER Device	22-3
22.2	Macros	22-4
22.3	Configuration Structure	22-6
22.4	Functions	22-7
22.4.1	Primary Functions	22-7
22.4.2	Auxiliary Functions and Constants	22-11
23	UTOPIA Module	23-1
	<i>Describes the UTOPIA module, lists the API functions and macros within the module, discusses how to use the UTOPIA interface, and provides a UTOP API reference section.</i>	
23.1	Overview	23-2
23.1.1	Using UTOPIA APIs	23-3

23.2	Macros	23-4
23.3	Configuration Structure	23-6
23.4	Functions	23-7
24	VCP Module	24-1
	<i>Describes the VCP module, lists the API functions and macros within the module, discusses how to use the VCP, and provides a VCP API reference section.</i>	
24.1	Overview	24-2
	24.1.1 Using the VCP	24-4
24.2	Macros	24-5
24.3	Configuration Structure	24-7
24.4	Functions	24-11
25	VIC Module	25-1
	<i>Describes the VIC module, lists the API functions and macros within the module, and provides a VIC reference section.</i>	
25.1	Overview	25-2
25.2	Macros	25-3
25.3	Functions	25-4
26	VP Module	26-1
	<i>Describes the VP module, lists the API functions and macros within the module, and provides a VP reference section</i>	
26.1	Overview	26-2
26.2	Configuration Structures	26-4
26.3	Functions and Constants	26-9
27	XBUS Module	27-1
	<i>Describes the XBUS module, lists the API functions and macros within the module, discusses how to use the XBUS device, and provides an XBUS API reference section.</i>	
27.1	Overview	27-2
27.2	Macros	27-2
27.3	Configuration Structure	27-4
27.4	Functions	27-5
28	Using the HAL Macros	28-1
	<i>Describes the hardware abstraction layer (HAL), gives a summary of the HAL macros, discusses RMK macros and macro token pasting, and provides a HAL macro reference section.</i>	
28.1	Introduction	28-2
	28.1.1 HAL Macro Symbols	28-2
	28.1.2 HAL Header Files	28-2
	28.1.3 HAL Macro Summary	28-3
28.2	Generic Macro Notation and Table of Macros	28-4

28.3	General Comments Regarding HAL Macros	28-6
28.3.1	Right-Justified Fields	28-6
28.3.2	_OF Macros	28-7
28.3.3	RMK Macros	28-8
28.3.4	Macro Token Pasting	28-11
28.3.5	Peripheral Register Data Sheet	28-11
28.4	HAL Macro Reference	28-12
A	Using CSL APIs Without DSP/BIOS ConfigTool	A-1
	<i>Provides an example of using CSL independently of the DSP/BIOS configuration tool.</i>	
A.1	Using CSL APIs	A-2
A.1.1	Using DMA_config()	A-2
A.1.2	Using DMA_configArgs()	A-5
A.2	Compiling and Linking With CSL Using Code Composer Studio IDE	A-7
A.2.1	CSL Directory Structure	A-7
A.2.2	Using the Code Composer Studio Project Environment	A-7
B	TMS320C6000 CSL Registers	B-1
	<i>Shows the registers associated with current TMS320C6000 DSPs.</i>	
B.1	Cache Registers	B-2
B.2	Direct Memory Access (DMA) Registers	B-17
B.3	Enhanced DMA (EDMA) Registers	B-31
B.4	EMAC Control Module Registers	B-60
B.5	EMAC Module Registers	B-64
B.6	External Memory Interface (EMIF) Registers	B-122
B.7	General-Purpose Input/Output (GPIO) Registers	B-149
B.8	Host Port Interface (HPI) Register	B-159
B.9	Inter-Integrated Circuit (I2C) Registers	B-168
B.10	Interrupt Request (IRQ) Registers	B-203
B.11	Multichannel Audio Serial Port (McASP) Registers	B-207
B.12	Multichannel Buffered Serial Port (McBSP) Registers	B-284
B.13	MDIO Module Registers	B-311
B.14	Peripheral Component Interconnect (PCI) Registers	B-328
B.15	Phase-Locked Loop (PLL) Registers	B-353
B.16	Power-Down Control Register	B-359
B.17	TCP Registers	B-360
B.18	Timer Registers	B-382
B.19	UTOPiA Registers	B-386
B.20	VCP Registers	B-396
B.21	VIC Port Registers	B-409
B.22	Video Port Control Registers	B-413
B.23	Video Capture Registers	B-427
B.24	Video Display Registers	B-462
B.25	Video Port GPIO Registers	B-504

Contents

B.26 Expansion Bus (XBUS) Registers B-529

C Old and New CACHE APIs C-1

D Glossary D-1

Figures

1-1	API Module Architecture	1-3
5-1	2D Transfer	5-7
A-1	Defining the Target Device in the Build Options Dialog Box	A-8
B-1	Cache Configuration Register (CCFG)	B-3
B-2	L2 EDMA Access Control Register (EDMAWEIGHT)	B-5
B-3	L2 Writeback Base Address Register (L2WBAR)	B-5
B-4	L2 Writeback Word Count Register (L2WWC)	B-6
B-5	L2 Writeback-Invalidate Base Address Register (L2WIBAR)	B-6
B-6	L2 Writeback-Invalidate Word Count Register (L2WIWC)	B-7
B-7	L2 Invalidate Base Address Register (L2IBAR)	B-7
B-8	L2 Writeback-Invalidate Word Count Register (L2IWC)	B-8
B-9	L2 Allocation Registers (L2ALLOC0-L2ALLOC3)	B-8
B-10	L1P Invalidate Base Address Register (L1PIBAR)	B-9
B-11	L1P Invalidate Word Count Register (L1PIWC)	B-9
B-12	L1D Writeback-Invalidate Base Address Register (L1DWIBAR)	B-10
B-13	L1D Writeback-Invalidate Word Count Register (L1DWIWC)	B-10
B-14	L1P Invalidate Base Address Register (L1PIBAR)	B-11
B-15	L1D Invalidate Word Count Register (L1DIWC)	B-11
B-16	L2 Writeback All Register (L2WB)	B-12
B-17	L2 Writeback-Invalidate All Register (L2WBINV)	B-13
B-18	L2 Memory Attribute Registers (MAR0-MAR15)	B-14
B-19	L2 Memory Attribute Registers (MAR96-MAR111)	B-15
B-20	L2 Memory Attribute Registers (MAR128-MAR191)	B-16
B-21	DMA Auxiliary Control Register (AUXCTL)	B-17
B-22	DMA Channel Primary Control Register (PRICTL)	B-19
B-23	DMA Channel Secondary Control Register (SECCTL)	B-24
B-24	DMA Channel Source Address Register (SRC)	B-28
B-25	DMA Channel Destination Address Register (DST)	B-28
B-26	DMA Channel Transfer Counter Register (XFRCNT)	B-29
B-27	DMA Global Count Reload Register (GBLCNT)	B-29
B-28	DMA Global Index Register (GBLIDX)	B-30
B-29	DMA Global Address Reload Register (GBLADDR)	B-30
B-30	EDMA Channel Options Register (OPT)	B-32
B-31	EDMA Channel Source Address Register (SRC)	B-36
B-32	EDMA Channel Transfer Count Register (CNT)	B-37
B-33	EDMA Channel Destination Address Register (DST)	B-37

B-34	EDMA Channel Index Register (IDX)	B-38
B-35	EDMA Channel Count Reload/Link Register (RLD)	B-38
B-36	EDMA Event Selector Register 0 (ESEL0)	B-39
B-37	EDMA Event Selector Register 1 (ESEL1)	B-40
B-38	EDMA Event Selector Register 3 (ESEL3)	B-41
B-39	Priority Queue Allocation Register (PQAR)	B-42
B-40	Priority Queue Status Register (PQSR)	B-43
B-41	Priority Queue Status Register (PQSR)	B-43
B-42	EDMA Channel Interrupt Pending Register (CIPR)	B-44
B-43	EDMA Channel Interrupt Pending Low Register (CIPRL)	B-45
B-44	EDMA Channel Interrupt Pending High Register (CIPRH)	B-45
B-45	EDMA Channel Interrupt Enable Register (CIER)	B-46
B-46	EDMA Channel Interrupt Enable Low Register (CIERL)	B-47
B-47	EDMA Channel Interrupt Enable High Register (CIERH)	B-47
B-48	EDMA Channel Chain Enable Register (CCER)	B-48
B-49	EDMA Channel Chain Enable Low Register (CCERL)	B-49
B-50	EDMA Channel Chain Enable High Register (CCERH)	B-49
B-51	EDMA Event Register (ER)	B-50
B-52	1EDMA Event High Register (ERH)	B-51
B-53	EDMA Event Enable Register (EER)	B-52
B-54	EDMA Event Enable Low Register (EERL)	B-53
B-55	EDMA Event Enable High Register (EERH)	B-53
B-56	EDMA Event Clear Register (ECR)	B-54
B-57	EDMA Event Clear Low Register (ECRL)	B-55
B-58	EDMA Event Clear High Register (ECRH)	B-55
B-59	EDMA Event Set Register (ESR)	B-56
B-60	EDMA Event Set Low Register (ESRL)	B-57
B-61	EDMA Event Set High Register (ESRH)	B-57
B-62	EDMA Event Polarity Low Register (EPRL)	B-58
B-63	EDMA Event Polarity High Register (EPRH)	B-59
B-64	EMAC Control Module Transfer Control Register (EWTRCTRL)	B-60
B-65	EMAC Control Module Interrupt Control Register (EWCTL)	B-62
B-66	EMAC Control Module Interrupt Timer Count Register (EWINTTCNT)	B-63
B-67	Transmit Identification and Version Register (TXIDVER)	B-67
B-68	Transmit Control Register (TXCONTROL)	B-68
B-69	Transmit Teardown Register (TXTEARDOWN)	B-69
B-70	Receive Identification and Version Register (RXIDVER)	B-70
B-71	Receive Control Register (RXCONTROL)	B-71
B-72	Receive Teardown Register (RXTEARDOWN)	B-72
B-73	Receive Multicast/Broadcast/Promiscuous Channel Enable Register (RXMBPENABLE)	B-73
B-74	Receive Unicast Set Register (RXUNICASTSET)	B-78
B-75	Receive Unicast Clear Register (RXUNICASTCLEAR)	B-80
B-76	Receive Maximum Length Register (RXMAXLEN)	B-82

B-77	Receive Buffer Offset Register (RXBUFFEROFFSET)	B-83
B-78	Receive Filter Low Priority Packets Threshold Register (RXFILTERLOWTHRESH) ...	B-84
B-79	Receive Channel n Flow Control Threshold Registers (RXnFLOWTHRESH)	B-85
B-80	Receive Channel n Free Buffer Count Registers (RXnFREEBUFFER)	B-86
B-81	MAC Control Register (MACCONTROL)	B-87
B-82	MAC Status Register (MACSTATUS)	B-89
B-83	Transmit Interrupt Status (Unmasked) Register (TXINTSTATRAW)	B-93
B-84	Transmit Interrupt Status (Masked) Register (TXINTSTATMASKED)	B-94
B-85	Transmit Interrupt Mask Set Register (TXINTMASKSET)	B-95
B-86	Transmit Interrupt Mask Clear Register (TXINTMASKCLEAR)	B-97
B-87	MAC Input Vector Register (MACINVECTOR)	B-99
B-88	Receive Interrupt Status (Unmasked) Register (RXINTSTATRAW)	B-100
B-89	Receive Interrupt Status (Masked) Register (RXINTSTATMASKED)	B-101
B-90	Receive Interrupt Mask Set Register (RXINTMASKSET)	B-102
B-91	Receive Interrupt Mask Clear Register (RXINTMASKCLEAR)	B-104
B-92	MAC Interrupt Status (Unmasked) Register (MACINTSTATRAW)	B-106
B-93	MAC Interrupt Status (Masked) Register (MACINTSTATMASKED)	B-107
B-94	MAC Interrupt Mask Set Register (MACINTMASKSET)	B-108
B-95	MAC Interrupt Mask Clear Register (MACINTMASKCLEAR)	B-109
B-96	MAC Address Channel n Lower Byte Register (MACADDRLn)	B-110
B-97	MAC Address Middle Byte Register (MACADDRM)	B-110
B-98	MAC Address High Bytes Register (MACADDRH)	B-111
B-99	MAC Address Hash 1 Register (MACHASH1)	B-112
B-100	MAC Address Hash 2 Register (MACHASH2)	B-113
B-101	Backoff Test Register (BOFFTEST)	B-114
B-102	Transmit Pacing Test Register (TPACETEST)	B-115
B-103	Receive Pause Timer Register (RXPAUSE)	B-116
B-104	Transmit Pause Timer Register (TXPAUSE)	B-117
B-105	Transmit Channel n DMA Head Descriptor Pointer Register (TXnHDP)	B-118
B-106	Receive Channel n DMA Head Descriptor Pointer Register (RXnHDP)	B-118
B-107	Transmit Channel n Interrupt Acknowledge Register (TXnINTACK)	B-119
B-108	Receive Channel n Interrupt Acknowledge Register (RXnINTACK)	B-120
B-109	Statistics Register	B-121
B-110	EMIF Global Control Register (GBLCTL)	B-123
B-111	EMIF Global Control Register (GBLCTL)	B-126
B-112	EMIF Global Control Register (GBLCTL)	B-128
B-113	EMIF CE Space Control Register (CECTL)	B-131
B-114	EMIF CE Space Control Register (CECTL)	B-133
B-115	EMIF CE Space Control Register (CECTL)	B-135
B-116	EMIF CE Space Secondary Control Register (CESEC)	B-137
B-117	EMIF SDRAM Control Register (SDCTL)	B-139
B-118	EMIF SDRAM Control Register (SDCTL)	B-141
B-119	EMIF SDRAM Control Register (SDCTL)	B-143
B-120	EMIF SDRAM Timing Register (SDTIM) (C620x/C670x)	B-145

B-121	EMIF SDRAM Timing Register (SDTIM) (C621x/C671x/C64x)	B-145
B-122	EMIF SDRAM Extension Register (SDEXT)	B-146
B-123	EMIF Peripheral Device Transfer Control Register (PDTCTL)	B-148
B-124	GPIO Enable Register (GPEN)	B-149
B-125	GPIO Direction Register (GPDIR)	B-150
B-126	GPIO Value Register (GPVAL)	B-151
B-127	GPIO Delta High Register (GPDH)	B-152
B-128	GPIO High Mask Register (GPHM)	B-153
B-129	GPIO Delta Low Register (GPDL)	B-154
B-130	GPIO Low Mask Register (GPLM)	B-155
B-131	GPIO Global Control Register (GPGC)	B-156
B-132	GPIO Interrupt Polarity Register (GPPOL)	B-158
B-133	HPI Control Register (HPIC)—C620x/C670x DSP	B-162
B-134	HPI Control Register (HPIC)—C621x/C671x DSP	B-163
B-135	HPI Control Register (HPIC)—C64x DSP	B-164
B-136	HPI Transfer Request Control Register (TRCTL)	B-167
B-137	I2C Own Address Register (I2COAR)	B-169
B-138	I2C Interrupt Enable Register (I2CIER)	B-170
B-139	I2C Status Register (I2CSTR)	B-171
B-140	Roles of the Clock Divide-Down Values (ICCL and ICCH)	B-177
B-141	I2C Clock Low-Time Divider Register (I2CCLKL)	B-177
B-142	I2C Clock High-Time Divider Register (I2CCLKH)	B-178
B-143	I2C Data Count Register (I2CCNT)	B-179
B-144	I2C Data Receive Register (I2CDRR)	B-180
B-145	I2C Slave Address Register (I2CSAR)	B-181
B-146	I2C Data Transmit Register (I2CDXR)	B-182
B-147	I2C Mode Register (I2CMODR)	B-183
B-148	Block Diagram Showing the Effects of the Digital Loopback Mode (DLB) Bit	B-190
B-149	I2C Interrupt Source Register (I2CISRC)	B-191
B-150	I2C Extended Mode Register (I2CEMDR)	B-192
B-151	I2C Prescaler Register (I2CPSC)	B-193
B-152	I2C Peripheral Identification Register 1 (I2CPID1)	B-194
B-153	I2C Peripheral Identification Register 2 (I2CPID2)	B-195
B-154	I2C Pin Function Register (I2CPFUNC)	B-196
B-155	I2C Pin Direction Register (I2CPDIR)	B-197
B-156	I2C Pin Data Input Register (I2CPDIN)	B-198
B-157	I2C Pin Data Output Register (I2CPDOUT)	B-199
B-158	I2C Pin Data Set Register (I2CPDSET)	B-201
B-159	I2C Pin Data Clear Register (I2CPDCLR)	B-202
B-160	Interrupt Multiplexer High Register (MUXH)	B-203
B-161	Interrupt Multiplexer Low Register (MuxL)	B-205
B-162	External Interrupt Polarity Register (EXTPOL)	B-206
B-163	Peripheral Identification Register (PID)	B-212
B-164	Power Down and Emulation Management Register (PWRDEMU)	B-213

B-165	Pin Function Register (PFUNC)	B-214
B-166	Pin Direction Register (PDIR)	B-216
B-167	Pin Data Output Register (PDOUT)	B-219
B-168	Pin Data Input Register (PDIN)	B-221
B-169	Pin Data Set Register (PDSET)	B-223
B-170	PDCLR Pin Data Clear Register (PDCLR)	B-225
B-171	Global Control Register (GBLCTL)	B-227
B-172	Audio Mute Control Register (AMUTE)	B-230
B-173	Digital Loopback Control Register (DLBCTL)	B-234
B-174	DIT Mode Control Register (DITCTL)	B-235
B-175	Receiver Global Control Register (RGBLCTL)	B-236
B-176	Receive Format Unit Bit Mask Register (RMASK)	B-238
B-177	Receive Bit Stream Format Register (RFMT)	B-239
B-178	Receive Frame Sync Control Register (AFSRCTL)	B-242
B-179	Receive Clock Control Register (ACLKRCTL)	B-243
B-180	Receive High-Frequency Clock Control Register (AHCLKRCTL)	B-245
B-181	Receive TDM Time Slot Register (RTDM)	B-247
B-182	Receiver Interrupt Control Register (RINTCTL)	B-248
B-183	Receiver Status Register (RSTAT)	B-250
B-184	Current Receive TDM Time Slot Register (R SLOT)	B-253
B-185	Receive Clock Check Control Register (RCLKCHK)	B-254
B-186	Receiver DMA Event Control Register (REVTCTL)	B-256
B-187	Transmitter Global Control Register (XGBLCTL)	B-257
B-188	Transmit Format Unit Bit Mask Register (XMASK)	B-260
B-189	Transmit Bit Stream Format Register (XFMT)	B-261
B-190	Transmit Frame Sync Control Register (AFSXCTL)	B-264
B-191	Transmit Clock Control Register (ACLKXCTL)	B-265
B-192	Transmit High Frequency Clock Control Register (AHCLKXCTL)	B-267
B-193	Transmit TDM Time Slot Register (XTDM)	B-269
B-194	Transmitter Interrupt Control Register (XINTCTL)	B-270
B-195	Transmitter Status Register (XSTAT)	B-272
B-196	Current Transmit TDM Time Slot Register (XSLOT)	B-275
B-197	Transmit Clock Check Control Register (XCLKCHK)	B-276
B-198	Transmitter DMA Event Control Register (XEVTCTL)	B-278
B-199	Serializer Control Registers (SRCTLn)	B-279
B-200	DIT Left Channel Status Registers (DITCSRA0–DITCSRA5)	B-281
B-201	DIT Right Channel Status Registers (DITCSR0–DITCSR5)	B-281
B-202	DIT Left Channel User Data Registers (DITUDRA0–DITUDRA5)	B-282
B-203	DIT Right Channel User Data Registers (DITUDRB0–DITUDRB5)	B-282
B-204	Transmit Buffer Registers (XBUFn)	B-283
B-205	Receive Buffer Registers (RBUFn)	B-283
B-206	Data Receive Register (DRR)	B-284
B-207	Data Transmit Register (DXR)	B-285
B-208	Serial Port Control Register (SPCR)	B-285

B-209	Pin Control Register (PCR)	B-290
B-210	Receive Control Register (RCR)	B-293
B-211	Transmit Control Register (XCR)	B-296
B-212	Sample Rate Generator Register (SRGR)	B-299
B-213	Multichannel Control Register (MCR)	B-301
B-214	Receive Channel Enable Register (RCER)	B-305
B-215	Transmit Channel Enable Register (XCER)	B-306
B-216	Enhanced Receive Channel Enable Registers (RCERE0-3)	B-307
B-217	Enhanced Transmit Channel Enable Registers (XCERE0-3)	B-309
B-218	MDIO Version Register (VERSION)	B-312
B-219	MDIO Control Register (CONTROL)	B-313
B-220	MDIO PHY Alive Indication Register (ALIVE)	B-315
B-221	MDIO PHY Link Status Register (LINK)	B-316
B-222	MDIO Link Status Change Interrupt Register (LINKINTRAW)	B-317
B-223	MDIO Link Status Change Interrupt (Masked) Register (LINKINTMASKED)	B-318
B-224	MDIO User Command Complete Interrupt Register (USERINTRAW)	B-319
B-225	MDIO User Command Complete Interrupt (Masked) Register (USERINTMASKED)	B-320
B-226	MDIO User Command Complete Interrupt Mask Set Register (USERINTMASKSET)	B-321
B-227	MDIO User Command Complete Interrupt Mask Clear Register (USERINTMASKCLEAR)	B-322
B-228	MDIO User Access Register 0 (USERACCESS0)	B-323
B-229	MDIO User Access Register 1 (USERACCESS1)	B-324
B-230	MDIO User PHY Select Register 0 (USERPHYSEL0)	B-326
B-231	MDIO User PHY Select Register 1 (USERPHYSEL1)	B-327
B-232	DSP Reset Source/Status Register (RSTSRC)	B-329
B-233	Power Management DSP Control/Status Register (PMDCSR)	B-332
B-234	PCI Interrupt Source Register (PCIIIS)	B-335
B-235	PCI Interrupt Enable Register (PCIIEN)	B-338
B-236	DSP Master Address Register (DSPMA)	B-341
B-237	PCI Master Address Register (PCIMA)	B-342
B-238	PCI Master Control Register (PCIMC)	B-343
B-239	Current DSP Address (CDSPA)	B-344
B-240	Current PCI Address Register (CPCIA)	B-344
B-241	Current Byte Count Register (CCNT)	B-345
B-242	EEPROM Address Register (EEADD)	B-346
B-243	EEPROM Data Register (EEDAT)	B-347
B-244	EEPROM Control Register (EECTL)	B-348
B-245	PCI Transfer Halt Register (HALT)	B-350
B-246	PCI Transfer Request Control Register (TRCTL)	B-351
B-247	PLL Controller Peripheral Identification Register (PLLPID)	B-353
B-248	PLL Control/Status Register (PLLCSR)	B-354
B-249	PLL Multiplier Control Register (PLLM)	B-356

B-250	PLL Controller Divider Register (PLLDIV)	B-357
B-251	Oscillator Divider 1 Register (OSCDIV1)	B-358
B-252	Power-Down Control Register (PDCTL)	B-359
B-253	TCP Input Configuration Register 0 (TCPIC0)	B-361
B-254	TCP Input Configuration Register 1 (TCPIC1)	B-363
B-255	TCP Input Configuration Register 2 (TCPIC2)	B-364
B-256	TCP Input Configuration Register 3 (TCPIC3)	B-365
B-257	TCP Input Configuration Register 4 (TCPIC4)	B-366
B-258	TCP Input Configuration Register 5 (TCPIC5)	B-367
B-259	TCP Input Configuration Register 6 (TCPIC6)	B-369
B-260	TCP Input Configuration Register 7 (TCPIC7)	B-370
B-261	TCP Input Configuration Register 8 (TCPIC8)	B-371
B-262	TCP Input Configuration Register 9 (TCPIC9)	B-372
B-263	TCP Input Configuration Register 10 (TCPIC10)	B-373
B-264	TCP Input Configuration Register 11 (TCPIC11)	B-374
B-265	TCP Output Parameter Register (TCPOUT)	B-375
B-266	TCP Execution Register (TCPEXE)	B-376
B-267	TCP Endian Register (TCPEND)	B-377
B-268	TCP Error Register (TCPERR)	B-378
B-269	TCP Status Register (TCPSTAT)	B-380
B-270	Timer Control Register (CTL)	B-382
B-271	Timer Period Register (PRD)	B-385
B-272	Timer Count Register (CNT)	B-385
B-273	UTOPIA Control Register (UCR)	B-386
B-274	UTOPIA Interrupt Enable Register (UIER)	B-389
B-275	UTOPIA Interrupt Pending Register (UIPR)	B-390
B-276	Clock Detect Register (CDR)	B-391
B-277	Error Interrupt Enable Registers (EIER)	B-392
B-278	Error Interrupt Pending Register (EIPR)	B-394
B-279	VCP Input Configuration Register 0 (VCPIC0)	B-397
B-280	VCP Input Configuration Register 1 (VCPIC1)	B-398
B-281	VCP Input Configuration Register 2 (VCPIC2)	B-399
B-282	VCP Input Configuration Register 3 (VCPIC3)	B-399
B-283	VCP Input Configuration Register 4 (VCPIC4)	B-400
B-284	VCP Input Configuration Register 5 (VCPIC5)	B-401
B-285	VCP Output Register 0 (VCPOUT0)	B-402
B-286	VCP Output Register 1 (VCPOUT1)	B-403
B-287	VCP Execution Register (VCPEXE)	B-404
B-288	VCP Endian Mode Register (VCPEND)	B-405
B-289	VCP Status Register 0 (VCPSTAT0)	B-406
B-290	VCP Status Register 1 (VCPSTAT1)	B-407
B-291	VCP Error Register (VCPERR)	B-408
B-292	VIC Control Register (VICCTL)	B-409
B-293	VIC Input Register (VICIN)	B-411

B-294	VIC Clock Divider Register (VICDIV)	B-412
B-295	Video Port Control Register (VPCTL)	B-414
B-296	Video Port Status Register (VPSTAT)	B-417
B-297	Video Port Interrupt Enable Register (VPIE)	B-418
B-298	Video Port Interrupt Status Register (VPIS)	B-421
B-299	Video Capture Channel x Status Register (VCASTAT, VCBSTAT)	B-429
B-300	Video Capture Channel A Control Register (VCACTL)	B-431
B-301	Video Capture Channel x Field 1 Start Register (VCASTRT1, VCBSTRT1)	B-436
B-302	Video Capture Channel x Field 1 Stop Register (VCASTOP1, VCBSTOP1)	B-438
B-303	Video Capture Channel x Field 2 Start Register (VCASTRT2, VCBSTRT2)	B-439
B-304	Video Capture Channel x Field 2 Stop Register (VCASTOP2, VCBSTOP2)	B-440
B-305	Video Capture Channel x Vertical Interrupt Register (VCAVINT, VCBVINT)	B-441
B-306	Video Capture Channel x Threshold Register (VCATHRLD, VCBTHRLD)	B-444
B-307	Video Capture Channel x Event Count Register (VCAEVTCT, VCBEVTCT)	B-445
B-308	Video Capture Channel B Control Register (VCBCTL)	B-446
B-309	TSI Capture Control Register (TSICTL)	B-451
B-310	TSI Clock Initialization LSB Register (TSICLKINITL)	B-453
B-311	TSI Clock Initialization MSB Register (TSICLKINITM)	B-454
B-312	TSI System Time Clock LSB Register (TSISTCLKL)	B-455
B-313	TSI System Time Clock MSB Register (TSISTCLKM)	B-456
B-314	TSI System Time Clock Compare LSB Register (TSISTCMPL)	B-457
B-315	TSI System Time Clock Compare MSB Register (TSISTCMPM)	B-458
B-316	TSI System Time Clock Compare Mask LSB Register (TSISTMSKL)	B-459
B-317	TSI System Time Clock Compare Mask MSB Register (TSISTMSKM)	B-460
B-318	TSI System Time Clock Ticks Interrupt Register (TSITICKS)	B-461
B-319	Video Display Status Register (VDSTAT)	B-463
B-320	Video Display Control Register (VDCTL)	B-465
B-321	Video Display Frame Size Register (VDFRMSZ)	B-470
B-322	Video Display Horizontal Blanking Register (VDHBLNK)	B-471
B-323	Video Display Field 1 Vertical Blanking Start Register (VDVBLKS1)	B-473
B-324	Video Display Field 1 Vertical Blanking End Register (VDVBLKE1)	B-474
B-325	Video Display Field 2 Vertical Blanking Start Register (VDVBLKS2)	B-476
B-326	Video Display Field 2 Vertical Blanking End Register (VDVBLKE2)	B-477
B-327	Video Display Field 1 Image Offset Register (VDIMGOFF1)	B-479
B-328	Video Display Field 1 Image Size Register (VDIMGSZ1)	B-480
B-329	Video Display Field 2 Image Offset Register (VDIMGOFF2)	B-481
B-330	Video Display Field 2 Image Size Register (VDIMGSZ2)	B-483
B-331	Video Display Field 1 Timing Register (VDFLDT1)	B-484
B-332	Video Display Field 2 Timing Register (VDFLDT2)	B-485
B-333	Video Display Threshold Register (VDTHRLD)	B-486
B-334	Video Display Horizontal Synchronization Register (VDHSYNC)	B-488
B-335	Video Display Field 1 Vertical Synchronization Start Register (VDVSYNS1)	B-489
B-336	Video Display Field 1 Vertical Synchronization End Register (VDVSYNE1)	B-490
B-337	Video Display Field 2 Vertical Synchronization Start Register (VDVSYNS2)	B-491

B-338	Video Display Field 2 Vertical Synchronization End Register (VDVSYNE2)	B-492
B-339	Video Display Counter Reload Register (VDRELOAD)	B-493
B-340	Video Display Display Event Register (VDDISPEVT)	B-494
B-341	Video Display Clipping Register (VDCLIP)	B-495
B-342	Video Display Default Display Value Register (VDDEFVAL)	B-496
B-343	Video Display Default Display Value Register (VDDEFVAL)—Raw Data Mode	B-497
B-344	Video Display Vertical Interrupt Register (VDVINT)	B-498
B-345	Video Display Field Bit Register (VDFBIT)	B-499
B-346	Video Display Field 1 Vertical Blanking Bit Register (VDVBIT1)	B-501
B-347	Video Display Field 2 Vertical Blanking Bit Register (VDVBIT2)	B-502
B-348	Video Port Peripheral Identification Register (VPPID)	B-505
B-349	Video Port Peripheral Control Register (PCR)	B-506
B-350	Video Port Pin Function Register (PFUNC)	B-508
B-351	Video Port Pin Direction Register (PDIR)	B-510
B-352	Video Port Pin Data Input Register (PDIN)	B-513
B-353	Video Port Pin Data Output Register (PDOUT)	B-515
B-354	Video Port Pin Data Set Register (PDSET)	B-517
B-355	Video Port Pin Data Clear Register (PDCLR)	B-519
B-356	Video Port Pin Interrupt Enable Register (PIEN)	B-521
B-357	Video Port Pin Interrupt Polarity Register (PIPOL)	B-523
B-358	Video Port Pin Interrupt Status Register (PISTAT)	B-525
B-359	Video Port Pin Interrupt Clear Register (PICLR)	B-527
B-360	Expansion Bus Global Control Register (XBGC)	B-529
B-361	Expansion Bus XCE Space Control Register (XCECTL)	B-531
B-362	Expansion Bus Host Port Interface Control Register (XBHC)	B-533
B-363	Expansion Bus Internal Master Address Register (XBIMA)	B-535
B-364	Expansion Bus External Address Register (XBEA)	B-535
B-365	Expansion Bus Data Register (XBD)	B-536
B-366	Expansion Bus Internal Slave Address Register (XBISA)	B-536

Tables

1-1	CSL Modules and Include Files	1-3
1-2	CSL Naming Conventions	1-5
1-3	CSL Data Types	1-6
1-4	Generic CSL Functions	1-7
1-5	Generic CSL Macros	1-10
1-6	Generic CSL Handle-Based Macros	1-11
1-7	Generic CSL Symbolic Constants	1-12
1-8	CSL API Module Support for TMS320C6000 Devices	1-15
1-9	CSL API Module Support for TMS320C641x and DM64x Devices	1-16
1-10	CSL Device Support Library Name and Symbol Conventions	1-17
2-1	CACHE APIs	2-2
2-2	CACHE Macros that Access Registers and Fields	2-4
2-3	CACHE Macros that Construct Register and Field Values	2-5
3-1	CHIP APIs	3-2
3-2	CHIP Macros that Access Registers and Fields	3-3
3-3	CHIP Macros that Construct Register and Field Values	3-3
4-1	CSL API	4-2
5-1	DAT APIs	5-2
6-1	DMA Configuration Structures	6-2
6-2	DMA APIs	6-2
6-3	DMA Macros that Access Registers and Fields	6-5
6-4	DMA Macros that Construct Register and Field Values	6-6
7-1	EDMA Configuration Structure	7-2
7-2	EDMA APIs	7-2
7-3	EDMA Macros That Access Registers and Fields	7-5
7-4	EDMA Macros that Construct Register and Field Values	7-6
8-1	EMAC Configuration Structure	8-2
8-2	EMAC APIs	8-2
8-3	EMAC Macros That Access Registers and Fields	8-4
8-4	EMAC Macros that Construct Registers and Fields	8-5
9-1	EMIF Configuration Structure	9-2
9-2	EMIF APIs	9-2
9-3	EMIF Macros that Access Registers and Fields	9-3
9-4	EMIF Macros that Construct Register and Field Values	9-4
10-1	EMIFA/EMIFB Configuration Structure	10-2
10-2	EMIFA/EMIFB APIs	10-2

10-3	EMIFA/EMIFB Macros that Access Registers and Fields	10-3
10-4	EMIFA/EMIFB Macros that Construct Register and Field Values	10-4
11-1	GPIO Configuration Structure	11-2
11-2	GPIO APIs	11-2
11-3	GPIO Macros that Access Registers and Fields	11-5
11-4	GPIO Macros that Construct Register and Field Values	11-6
12-1	HPI APIs	12-2
12-2	HPI Macros that Access Registers and Fields	12-3
12-3	HPI Macros that Construct Register and Field Values	12-4
13-1	I2C Configuration Structures	13-2
13-2	I2C APIs	13-2
13-3	I2C Macros that Access Registers and Fields	13-5
13-4	I2C Macros that Construct Register and Field Values	13-6
14-1	IRQ Configuration Structure	14-2
14-2	IRQ APIs	14-2
14-3	IRQ Macros that Access Registers and Fields	14-4
14-4	IRQ Macros that Construct Register and Field Values	14-5
15-1	McASP Configuration Structures	15-2
15-2	McASP APIs	15-2
15-3	McASP Macros that Access Registers and Fields	15-5
15-4	McASP Macros that Construct Register and Field Values	15-6
16-1	McBSP Configuration Structure	16-2
16-2	McBSP APIs	16-2
16-3	McBSP Macros that Access Registers and Fields	16-5
16-4	McBSP Macros that Construct Register and Field Values	16-6
17-1	MDIO Functions and Constants	17-2
17-2	MDIO Macros That Access Registers and Fields	17-3
17-3	MDIO Macros that Construct Register and Field Values	17-3
18-1	PCI Configuration Structure	18-2
18-2	PCI APIs	18-2
18-3	PCI Macros that Access Registers and Fields	18-4
18-4	PCI Macros that Construct Register and Field Values	18-5
19-1	PLL Configuration Structures	19-2
19-2	PLL APIs	19-2
19-3	PLL Macros that Access Registers and Fields	19-4
19-4	PLL Macros that Construct Register and Field Values	19-5
20-1	PWR Configuration Structure	20-2
20-2	PWR APIs	20-2
20-3	PWR Macros that Access Registers and Fields	20-3
20-4	PWR Macros that Construct Register and Field Values	20-4
21-1	TCP Configuration Structures	21-2
21-2	TCP APIs	21-2
21-3	TCP Macros that Access Registers and Fields	21-7
21-4	TCP Macros that Construct Register and Field Values	21-7

22-1	TIMER Configuration Structure	22-2
22-2	TIMER APIs	22-2
22-3	TIMER Macros that Access Registers and Fields	22-4
22-4	TIMER Macros that Construct Register and Field Values	22-5
23-1	UTOPIA Configuration Structure	23-2
23-2	UTOPIA APIs	23-2
23-3	UTOP Macros that Access Registers and Fields	23-4
23-4	UTOP Macros that Construct Register and Field Values	23-5
24-1	VCP Configuration Structures	24-2
24-2	VCP APIs	24-2
24-3	VCP Macros that Access Registers and Fields	24-5
24-4	VCP Macros that Construct Register and Field Values	24-6
25-1	VIC Functions and Constants	25-2
25-2	VIC Macros That Access Registers and Fields	25-3
25-3	VIC Macros That Construct Register and Field Values	25-3
26-1	Configuration Structures (Macros)	26-2
26-2	VP APIs and Constants	26-2
27-1	XBUS Configuration Structure	27-2
27-2	XBUS APIs	27-2
27-3	XBUS Macros that Access Registers and Fields	27-3
27-4	XBUS Macros that Construct Register and Field Values	27-3
28-1	CSL HAL Macros	28-5
A-1	CSL Directory Structure	A-7
B-1	Cache Registers	B-2
B-2	Cache Configuration Register (CCFG) Field Values	B-3
B-3	L2 EDMA Access Control Register (EDMAWEIGHT) Field Values	B-5
B-4	L2 Writeback Base Address Register (L2WBAR) Field Values	B-5
B-5	L2 Writeback Word Count Register (L2WWC) Field Values	B-6
B-6	L2 Writeback-Invalidate Base Address Register (L2WIBAR) Field Values	B-6
B-7	L2 Writeback-Invalidate Word Count Register (L2WIWC) Field Values	B-7
B-8	L2 Invalidate Base Address Register (L2IBAR) Field Values	B-7
B-9	L2 Invalidate Word Count Register (L2IWC) Field Values	B-8
B-10	L2 Allocation Registers (L2ALLOC0-L2ALLOC3) Field Values	B-8
B-11	L1P Invalidate Base Address Register (L1PIBAR) Field Values	B-9
B-12	L1P Invalidate Word Count Register (L1PIWC) Field Values	B-9
B-13	L1D Writeback-Invalidate Base Address Register (L1DWIBAR) Field Values	B-10
B-14	L1D Writeback-Invalidate Word Count Register (L1DWIWC) Field Values	B-10
B-15	L1D Invalidate Base Address Register (L1DIBAR) Field Values	B-11
B-16	L1D Invalidate Word Count Register (L1DIWC) Field Values	B-11
B-17	L2 Writeback All Register (L2WB) Field Values	B-12
B-18	L2 Writeback-Invalidate All Register (L2WBINV) Field Values	B-13
B-19	L2 Memory Attribute Registers (MAR0-MAR15) Field Values	B-14
B-20	L2 Memory Attribute Registers (MAR96-MAR111) Field Values	B-15
B-21	L2 Memory Attribute Registers (MAR128-MAR191) Field Values	B-16

B-22	DMA Registers	B-17
B-23	DMA Auxiliary Control Register (AUXCTL) Field Values	B-18
B-24	DMA Channel Primary Control Register (PRCTL) Field Values	B-19
B-25	DMA Channel Secondary Control Register (SECCTL) Field Values	B-24
B-26	DMA Channel Source Address Register (SRC) Field Values	B-28
B-27	DMA Channel Destination Address Register (DST) Field Values	B-28
B-28	DMA Channel Transfer Counter Register (XFRCNT) Field Values	B-29
B-29	DMA Global Count Reload Register (GBLCNT) Field Values	B-29
B-30	DMA Global Index Register (GBLIDX) Field Values	B-30
B-31	DMA Global Address Reload Register (GBLADDR) Field Values	B-30
B-32	EDMA Registers	B-31
B-33	EDMA Channel Options Register (OPT) Field Values	B-33
B-34	EDMA Channel Source Address Register (SRC) Field Values	B-36
B-35	EDMA Channel Transfer Count Register (CNT) Field Values	B-37
B-36	EDMA Channel Destination Address Register (DST) Field Values	B-37
B-37	EDMA Channel Index Register (IDX) Field Values	B-38
B-38	EDMA Channel Count Reload/Link Register (RLD) Field Values	B-38
B-39	EDMA Event Selector Register 0 (ESEL0) Field Values	B-39
B-40	EDMA Event Selector Register 0 (ESEL1) Field Values	B-40
B-41	EDMA Event Selector Register 0 (ESEL3) Field Values	B-41
B-42	Priority Queue Allocation Register (PQAR) Field Values	B-42
B-43	Priority Queue Status Register (PQSR) Field Values	B-43
B-44	Priority Queue Status Register (PQSR) Field Values	B-43
B-45	EDMA Channel Interrupt Pending Register (CIPR) Field Values	B-44
B-46	EDMA Channel Interrupt Pending Low Register (CIPRL) Field Values	B-45
B-47	EDMA Channel Interrupt Pending High Register (CIPRH) Field Values	B-45
B-48	C621x/C671x: Channel Interrupt Enable Register (CIER) Field Values	B-46
B-49	EDMA Channel Interrupt Enable Low Register (CIERL) Field Values	B-47
B-50	EDMA Channel Interrupt Enable High Register (CIERH) Field Values	B-47
B-51	EDMA Channel Chain Enable Register (CCER) Field Values	B-48
B-52	EDMA Channel Chain Enable Low Register (CCERL) Field Values	B-49
B-53	EDMA Channel Chain Enable High Register (CCERH) Field Values	B-49
B-54	EDMA Event Register (ER) Field Values	B-50
B-55	EDMA Event Low Register (ERL) Field Values	B-51
B-56	EDMA Event High Register (ERH) Field Values	B-51
B-57	EDMA Event Enable Register (EER) Field Values	B-52
B-58	EDMA Event Low Register (EERL) Field Values	B-53
B-59	EDMA Event Enable High Register (EERH) Field Values	B-53
B-60	EDMA Event Clear Register (ERC) Field Values	B-54
B-61	EDMA Event Clear Low Register (ERCL) Field Values	B-55
B-62	EDMA Event Clear High Register (ECRH) Field Values	B-55
B-63	EDMA Event Set Register (ESR) Field Values	B-56
B-64	EDMA Event Set Low Register (ESRL) Field Values	B-57
B-65	EDMA Event Set High Register (ESRH) Field Values	B-57

B-66	EDMA Event Polarity Low Register (EPRL) Field Values	B-58
B-67	EDMA Event Polarity High Register (EPRH) Field Values	B-59
B-68	EMAC Control Module Registers	B-60
B-69	EMAC Control Module Transfer Control Register (EWTRCTRL) Field Values	B-61
B-70	EMAC Control Module Interrupt Control Register (EWCTL) Field Values	B-62
B-71	EMAC Control Module Interrupt Timer Count Register (EWINTTCNT) Field Values	B-63
B-72	EMAC Module Registers	B-64
B-73	Transmit Identification and Version Register (TXIDVER) Field Values	B-67
B-74	Transmit Control Register (TXCONTROL) Field Values	B-68
B-75	Transmit Teardown Register (TXTEARDOWN) Field Values	B-69
B-76	Receive Identification and Version Register (RXIDVER) Field Values	B-70
B-77	Receive Control Register (RXCONTROL) Field Values	B-71
B-78	Receive Teardown Register (RXTEARDOWN) Field Values	B-72
B-79	Receive Multicast/Broadcast/Promiscuous Channel Enable Register (RXMBPENABLE) Field Values	B-73
B-80	Receive Unicast Set Register (RXUNICASTSET) Field Values	B-78
B-81	Receive Unicast Clear Register (RXUNICASTCLEAR) Field Values	B-80
B-82	Receive Maximum Length Register (RXMAXLEN) Field Values	B-82
B-83	Receive Buffer Offset Register (RXBUFFEROFFSET) Field Values	B-83
B-84	Receive Filter Low Priority Packets Threshold Register (RXFILTERLOWTHRESH) Field Values	B-84
B-85	Receive Channel n Flow Control Threshold Registers (RXnFLOWTHRESH) Field Values	B-85
B-86	Receive Channel n Free Buffer Count Registers (RXnFREEBUFFER) Field Values	B-86
B-87	MAC Control Register (MACCONTROL) Field Values	B-87
B-88	MAC Status Register (MACSTATUS) Field Values	B-90
B-89	Transmit Interrupt Status (Unmasked) Register (TXINTSTATRAW) Field Values	B-93
B-90	Transmit Interrupt Status (Masked) Register (TXINTSTATMASKED) Field Values	B-94
B-91	Transmit Interrupt Mask Set Register (TXINTMASKSET) Field Values	B-95
B-92	Transmit Interrupt Mask Clear Register (TXINTMASKCLEAR) Field Values	B-97
B-93	MAC Input Vector Register (MACINVECTOR) Field Values	B-99
B-94	Receive Interrupt Status (Unmasked) Register (RXINTSTATRAW) Field Values	B-100
B-95	Receive Interrupt Status (Masked) Register (RXINTSTATMASKED) Field Values	B-101
B-96	Receive Interrupt Mask Set Register (RXINTMASKSET) Field Values	B-102
B-97	Receive Interrupt Mask Clear Register (RXINTMASKCLEAR) Field Values	B-104
B-98	MAC Interrupt Status (Unmasked) Register (MACINTSTATRAW) Field Values	B-106
B-99	MAC Interrupt Status (Masked) Register (MACINTSTATMASKED) Field Values	B-107
B-100	MAC Interrupt Mask Set Register (MACINTMASKSET) Field Values	B-108
B-101	MAC Interrupt Mask Clear Register (MACINTMASKCLEAR) Field Values	B-109
B-102	MAC Address Channel n Lower Byte Register (MACADDRLn) Field Values	B-110
B-103	MAC Address Middle Byte Register (MACADDRM) Field Values	B-110
B-104	MAC Address High Bytes Register (MACADDRH) Field Values	B-111
B-105	MAC Address Hash 1 Register (MACHASH1) Field Values	B-112
B-106	MAC Address Hash 2 Register (MACHASH2) Field Values	B-113

B-107	Backoff Test Register (BOFFTEST) Field Values	B-114
B-108	Transmit Pacing Test Register (TPACETEST) Field Values	B-115
B-109	Receive Pause Timer Register (RXPAUSE) Field Values	B-116
B-110	Transmit Pause Timer Register (TXPAUSE) Field Values	B-117
B-111	Transmit Channel n DMA Head Descriptor Pointer Register (TXnHDP) Field Values	B-118
B-112	Receive Channel n DMA Head Descriptor Pointer Register (RXnHDP) Field Values	B-118
B-113	Transmit Channel n Interrupt Acknowledge Register (TXnINTACK) Field Values	B-119
B-114	Receive Channel n Interrupt Acknowledge Register (RXnINTACK) Field Values	B-120
B-115	EMIF Registers	B-122
B-116	EMIF Global Control Register (GBLCTL) Field Values	B-123
B-117	EMIF Global Control Register (GBLCTL) Field Values	B-126
B-118	EMIF Global Control Register (GBLCTL) Field Values	B-128
B-119	EMIF CE Space Control Register (CECTL) Field Values	B-131
B-120	EMIF CE Space Control Register (CECTL) Field Values	B-133
B-121	EMIF CE Space Control Register (CECTL) Field Values	B-135
B-122	EMIF CE Space Secondary Control Register (CESEC) Field Values	B-137
B-123	EMIF SDRAM Control Register (SDCTL) Field Values	B-139
B-124	EMIF SDRAM Control Register (SDCTL) Field Values	B-141
B-125	EMIF SDRAM Control Register (SDCTL) Field Values	B-143
B-126	EMIF SDRAM Timing Register (SDTIM) Field Values	B-145
B-127	EMIF SDRAM Extension Register (SDEXT) Field Values	B-146
B-128	EMIF Peripheral Device Transfer Control Register (PDTCTL) Field Values	B-148
B-129	GPIO Registers	B-149
B-130	GPIO Enable Register (GPEN) Field Values	B-150
B-131	GPIO Direction Register (GPDIR) Field Values	B-150
B-132	GPIO Value Register (GPVAL) Field Values	B-151
B-133	GPIO Delta High Register (GPDH) Field Values	B-152
B-134	GPIO High Mask Register (GPHM) Field Values	B-153
B-135	GPIO Delta Low Register (GDDL) Field Values	B-154
B-136	GPIO Low Mask Register (GPLM) Field Values	B-155
B-137	GPIO Global Control Register (GPGC) Field Values	B-156
B-138	GPIO Interrupt Polarity Register (GPPOL) Field Values	B-158
B-139	HPI Registers for C62x/C67x DSP	B-159
B-140	HPI Registers for C64x DSP	B-159
B-141	HPI Control Register (HPIC) Field Values	B-165
B-142	HPI Transfer Request Control Register (TRCTL) Field Values	B-167
B-143	I2C Module Registers	B-168
B-144	I2C Own Address Register (I2COAR) Field Values	B-169
B-145	I2C Interrupt Enable Register (I2CIER) Field Values	B-170
B-146	I2C Status Register (I2CSTR) Field Values	B-172
B-147	I2C Clock Low-Time Divider Register (I2CCLKL) Field Values	B-178

B-148	I2C Clock High-Time Divider Register (I2CCLKH) Field Values	B-178
B-149	I2C Data Count Register (I2CCNT) Field Values	B-179
B-150	I2C Data Receive Register (I2CDRR) Field Values	B-180
B-151	I2C Slave Address Register (I2CSAR) Field Values	B-181
B-152	I2C Data Transmit Register (I2CDXR) Field Values	B-182
B-153	I2C Mode Register (I2CMR) Field Values	B-183
B-154	Master-Transmitter/Receiver Bus Activity Defined by RM, STT, and STP Bits	B-189
B-155	How the MST and FDF Bits Affect the Role of TRX Bit	B-189
B-156	I2C Interrupt Source Register (I2CISRC) Field Values	B-191
B-157	I2C Extended Mode Register (I2CEMR) Field Values	B-192
B-158	I2C Prescaler Register (I2CPSR) Field Values	B-193
B-159	I2C Peripheral Identification Register 1 (I2CPID1) Field Values	B-194
B-160	I2C Peripheral Identification Register 2 (I2CPID2) Field Values	B-195
B-161	I2C Pin Function Register (I2CPFUNC) Field Values	B-196
B-162	I2C Pin Direction Register (I2CPDIR) Field Values	B-197
B-163	I2C Pin Data Input Register (I2CPDIN) Field Values	B-198
B-164	I2C Pin Data Output Register (I2CPDOUT) Field Values	B-200
B-165	I2C Pin Data Set Register (I2CPDSET) Field Values	B-201
B-166	I2C Pin Data Clear Register (I2CPDCLR) Field Values	B-202
B-167	IRQ Registers	B-203
B-168	Interrupt Multiplexer High Register (MUXH) Field Values	B-204
B-169	Interrupt Multiplexer Low Register (MUXL) Field Values	B-205
B-170	External Interrupt Polarity Register (EXTPOL) Field Values	B-206
B-171	McASP Registers Accessed Through Configuration Bus	B-207
B-172	McASP Registers Accessed Through Data Port	B-211
B-173	Peripheral Identification Register (PID) Field Values	B-212
B-174	Power Down and Emulation Management Register (PWRDEMU) Field Values	B-213
B-175	Pin Function Register (PFUNC) Field Values	B-215
B-176	Pin Direction Register (PDIR) Field Values	B-217
B-177	Pin Data Output Register (PDOUT) Field Values	B-220
B-178	Pin Data Input Register (PDIN) Field Values	B-222
B-179	Pin Data Set Register (PDSET) Field Values	B-224
B-180	Pin Data Clear Register (PDCLR) Field Values	B-226
B-181	Global Control Register (GBLCTL) Field Values	B-228
B-182	Audio Mute Control Register (AMUTE) Field Values	B-231
B-183	Digital Loopback Control Register (DLBCTL) Field Values	B-234
B-184	DIT Mode Control Register (DITCTL) Field Values	B-235
B-185	Receiver Global Control Register (RGBLCTL) Field Values	B-236
B-186	Receive Format Unit Bit Mask Register (RMASK) Field Values	B-238
B-187	Receive Bit Stream Format Register (RFMT) Field Values	B-239
B-188	Receive Frame Sync Control Register (AFSRCTL) Field Values	B-242
B-189	Receive Clock Control Register (ACLKRCTL) Field Values	B-244
B-190	Receive High-Frequency Clock Control Register (AHCLKRCTL) Field Values	B-245
B-191	Receive TDM Time Slot Register (RTDM) Field Values	B-247

B-192	Receiver Interrupt Control Register (RINTCTL) Field Values	B-248
B-193	Receiver Status Register (RSTAT) Field Values	B-250
B-194	Current Receive TDM Time Slot Register (RSLOT) Field Values	B-253
B-195	Receive Clock Check Control Register (RCLKCHK) Field Values	B-254
B-196	Receiver DMA Event Control Register (REVTCTL) Field Values	B-256
B-197	Transmitter Global Control Register (XGBLCTL) Field Values	B-257
B-198	Transmit Format Unit Bit Mask Register (XMASK) Field Values	B-260
B-199	Transmit Bit Stream Format Register (XFMT) Field Values	B-261
B-200	Transmit Frame Sync Control Register (AFSXCTL) Field Values	B-264
B-201	Transmit Clock Control Register (ACLKXCTL) Field Values	B-266
B-202	Transmit High-Frequency Clock Control Register (AHCLKXCTL) Field Values	B-267
B-203	Transmit TDM Time Slot Register (XTDM) Field Values	B-269
B-204	Transmitter Interrupt Control Register (XINTCTL) Field Values	B-270
B-205	Transmitter Status Register (XSTAT) Field Values	B-273
B-206	Current Transmit TDM Time Slot Register (XSLOT) Field Values	B-275
B-207	Transmit Clock Check Control Register (XCLKCHK) Field Values	B-276
B-208	Transmitter DMA Event Control Register (XEVTCTL) Field Values	B-278
B-209	Serializer Control Registers (SRCTLn) Field Values	B-279
B-210	McBSP Registers	B-284
B-211	Data Receive Register (DRR) Field Values	B-284
B-212	Data Transmit Register (DXR) Field Values	B-285
B-213	Serial Port Control Register (SPCR) Field Values	B-286
B-214	Pin Control Register (PCR) Field Values	B-290
B-215	Receive Control Register (RCR) Field Values	B-294
B-216	Transmit Control Register (XCR) Field Values	B-296
B-217	Sample Rate Generator Register (SRGR) Field Values	B-299
B-218	Multichannel Control Register (MCR) Field Values	B-301
B-219	Receive Channel Enable Register (RCER) Field Values	B-305
B-220	Transmit Channel Enable Register (XCER) Field Values	B-306
B-221	Enhanced Receive Channel Enable Registers (RCERE0-3) Field Values	B-307
B-222	Channel Enable Bits in RCEREn for a 128-Channel Data Stream	B-308
B-223	Enhanced Transmit Channel Enable Registers (XCERE0-3) Field Values	B-309
B-224	Channel Enable Bits in XCEREn for a 128-Channel Data Stream	B-310
B-225	MDIO Module Registers	B-311
B-226	MDIO Version Register (VERSION) Field Values	B-312
B-227	MDIO Control Register (CONTROL) Field Values	B-313
B-228	MDIO PHY Alive Indication Register (ALIVE) Field Values	B-315
B-229	MDIO PHY Link Status Register (LINK) Field Values	B-316
B-230	MDIO Link Status Change Interrupt Register (LINKINTRAW) Field Values	B-317
B-231	MDIO Link Status Change Interrupt (Masked) Register (LINKINTMASKED) Field Values	B-318
B-232	MDIO User Command Complete Interrupt Register (USERINTRAW) Field Values	B-319
B-233	MDIO User Command Complete Interrupt (Masked) Register (USERINTMASKED) Field Values	B-320

B-234	MDIO User Command Complete Interrupt Mask Set Register (USERINTMASKSET) Field Values	B-321
B-235	MDIO User Command Complete Interrupt Mask Clear Register (USERINTMASKCLEAR) Field Values	B-322
B-236	MDIO User Access Register 0 (USERACCESS0) Field Values	B-323
B-237	MDIO User Access Register 1 (USERACCESS1) Field Values	B-325
B-238	MDIO User PHY Select Register 0 (USERPHYSEL0) Field Values	B-326
B-239	MDIO User PHY Select Register 1 (USERPHYSEL1) Field Values	B-327
B-240	PCI Memory-Mapped Registers	B-328
B-241	DSP Reset Source/Status Register (RSTSRC) Field Values	B-329
B-242	Power Management DSP Control/Status Register (PMDCSR) Field Values	B-332
B-243	PCI Interrupt Source Register (PCIIIS) Field Values	B-335
B-244	PCI Interrupt Enable Register (PCIIEN) Field Values	B-338
B-245	DSP Master Address Register (DSPMA) Field Values	B-341
B-246	PCI Master Address Register (PCIMA) Field Values	B-342
B-247	PCI Master Control Register (PCIMC) Field Values	B-343
B-248	Current DSP Address (CDSPA) Field Values	B-344
B-249	Current PCI Address Register (CPCIA) Field Values	B-344
B-250	Current Byte Count Register (CCNT) Field Values	B-345
B-251	EEPROM Address Register (EEADD) Field Values	B-346
B-252	EEPROM Data Register (EEDAT) Field Values	B-347
B-253	EEPROM Control Register (EECTL) Field Values	B-348
B-254	PCI Transfer Halt Register (HALT) Field Values	B-350
B-255	PCI Transfer Request Control Register (TRCTL) Field Values	B-352
B-256	PLL Controller Registers	B-353
B-257	PLL Controller Peripheral Identification Register (PLLPID) Field Values	B-354
B-258	PLL Control/Status Register (PLLCSR) Field Values	B-355
B-259	PLL Multiplier Control Register (PLLM) Field Values	B-356
B-260	PLL Controller Divider Register (PLLDIV) Field Values	B-357
B-261	Oscillator Divider 1 Register (OSCDIV1) Field Values	B-358
B-262	Power-Down Control Register (PDCTL) Field Values	B-359
B-263	TCP Registers	B-360
B-264	TCP Input Configuration Register 0 (TCPIC0) Field Values	B-361
B-265	TCP Input Configuration Register 1 (TCPIC1) Field Values	B-363
B-266	TCP Input Configuration Register 2 (TCPIC2) Field Values	B-364
B-267	TCP Input Configuration Register 3 (TCPIC3) Field Values	B-365
B-268	TCP Input Configuration Register 4 (TCPIC4) Field Values	B-366
B-269	TCP Input Configuration Register 5 (TCPIC5) Field Values	B-367
B-270	TCP Input Configuration Register 6 (TCPIC6) Field Values	B-369
B-271	TCP Input Configuration Register 7 (TCPIC7) Field Values	B-370
B-272	TCP Input Configuration Register 8 (TCPIC8) Field Values	B-371
B-273	TCP Input Configuration Register 9 (TCPIC9) Field Values	B-372
B-274	TCP Input Configuration Register 10 (TCPIC10) Field Values	B-373
B-275	TCP Input Configuration Register 11 (TCPIC11) Field Values	B-374

B-276	TCP Output Parameter Register (TCPOUT) Field Values	B-375
B-277	TCP Execution Register (TCPEXE) Field Values	B-376
B-278	TCP Endian Register (TCPEND) Field Values	B-377
B-279	TCP Error Register (TCPERR) Field Values	B-378
B-280	TCP Status Register (TCPSTAT) Field Values	B-380
B-281	Timer Registers	B-382
B-282	Timer Control Register (CTL) Field Values	B-383
B-283	Timer Period Register (PRD) Field Values	B-385
B-284	Timer Count Register (CNT) Field Values	B-385
B-285	UTOPIA Configuration Registers	B-386
B-286	UTOPIA Control Register (UCR) Field Values	B-387
B-287	UTOPIA Interrupt Enable Register (UIER) Field Values	B-389
B-288	UTOPIA Interrupt Pending Register (UIPR) Field Values	B-390
B-289	Clock Detect Register (CDR) Field Values	B-391
B-290	Error Interrupt Enable Register (EIER) Field Values	B-393
B-291	Error Interrupt Pending Register (EIPR) Field Values	B-394
B-292	EDMA Bus Accesses Memory Map	B-396
B-293	VCP Input Configuration Register 0 (VCPIC0) Field Values	B-397
B-294	VCP Input Configuration Register 1 (VCPIC1) Field Values	B-398
B-295	VCP Input Configuration Register 2 (VCPIC2) Field Values	B-399
B-296	VCP Input Configuration Register 3 (VCPIC3) Field Values	B-399
B-297	VCP Input Configuration Register 4 (VCPIC4) Field Values	B-400
B-298	VCP Input Configuration Register 5 (VCPIC5) Field Values	B-401
B-299	VCP Output Register 0 (VCPOUT0) Field Values	B-402
B-300	VCP Output Register 1 (VCPOUT1) Field Values	B-403
B-301	VCP Execution Register (VCPEXE) Field Values	B-404
B-302	VCP Endian Mode Register (VCPEND) Field Values	B-405
B-303	VCP Status Register 0 (VCPSTAT0) Field Values	B-406
B-304	VCP Status Register 1 (VCPSTAT1) Field Values	B-407
B-305	VCP Error Register (VCPERR) Field Values	B-408
B-306	VIC Port Registers	B-409
B-307	VIC Control Register (VICCTL) Field Values	B-410
B-308	VIC Input Register (VICIN) Field Values	B-411
B-309	VIC Clock Divider Register (VICDIV) Field Values	B-412
B-310	Video Port Control Registers	B-413
B-311	Video Port Control Register (VPCTL) Field Values	B-414
B-312	Video Port Operating Mode Selection	B-416
B-313	Video Port Status Register (VPSTAT) Field Values	B-417
B-314	Video Port Interrupt Enable Register (VPIE) Field Values	B-418
B-315	Video Port Interrupt Status Register (VPIS) Field Values	B-421
B-316	Video Capture Control Registers	B-427
B-317	Video Capture Channel x Status Register (VCxSTAT) Field Values	B-429
B-318	Video Capture Channel A Control Register (VCACTL) Field Values	B-431
B-319	Video Capture Channel x Field 1 Start Register (VCxSTRT1) Field Values	B-437

B-320	Video Capture Channel x Field 1 Stop Register (VCxSTOP1) Field Values	B-438
B-321	Video Capture Channel x Field 2 Start Register (VCxSTRT2) Field Values	B-439
B-322	Video Capture Channel x Field 2 Stop Register (VCxSTOP2) Field Values	B-440
B-323	Video Capture Channel x Vertical Interrupt Register (VCxVINT) Field Values	B-442
B-324	Video Capture Channel x Threshold Register (VCxTHRLD) Field Values	B-444
B-325	Video Capture Channel x Event Count Register (VCxEVTCT) Field Values	B-445
B-326	Video Capture Channel B Control Register (VCBCTL) Field Values	B-446
B-327	TSI Capture Control Register (TSICTL) Field Values	B-451
B-328	TSI Clock Initialization LSB Register (TSICLKINITL) Field Values	B-453
B-329	TSI Clock Initialization MSB Register (TSICLKINITM) Field Values	B-454
B-330	TSI System Time Clock LSB Register (TSISTCLKL) Field Values	B-455
B-331	TSI System Time Clock MSB Register (TSISTCLKM) Field Values	B-456
B-332	TSI System Time Clock Compare LSB Register (TSISTCMPL) Field Values	B-457
B-333	TSI System Time Clock Compare MSB Register (TSISTCMPM) Field Values	B-458
B-334	TSI System Time Clock Compare Mask LSB Register (TSISTMSKL) Field Values	B-459
B-335	TSI System Time Clock Compare Mask MSB Register (TSISTMSKM) Field Values	B-460
B-336	TSI System Time Clock Ticks Interrupt Register (TSITICKS) Field Values	B-461
B-337	Video Display Control Registers	B-462
B-338	Video Display Status Register (VDSTAT) Field Values	B-464
B-339	Video Display Control Register (VDCTL) Field Values	B-465
B-340	Video Display Frame Size Register (VDFRMSZ) Field Values	B-470
B-341	Video Display Horizontal Blanking Register (VDHBLNK) Field Values	B-472
B-342	Video Display Field 1 Vertical Blanking Start Register (VDVBLKS1) Field Values	B-473
B-343	Video Display Field 1 Vertical Blanking End Register (VDVBLKE1) Field Values	B-475
B-344	Video Display Field 2 Vertical Blanking Start Register (VDVBLKS2) Field Values	B-476
B-345	Video Display Field 2 Vertical Blanking End Register (VDVBLKE2) Field Values	B-478
B-346	Video Display Field 1 Image Offset Register (VDIMGOFF1) Field Values	B-479
B-347	Video Display Field 1 Image Size Register (VDIMGSZ1) Field Values	B-480
B-348	Video Display Field 2 Image Offset Register (VDIMGOFF2) Field Values	B-482
B-349	Video Display Field 2 Image Size Register (VDIMGSZ2) Field Values	B-483
B-350	Video Display Field 1 Timing Register (VDFLDT1) Field Values	B-484
B-351	Video Display Field 2 Timing Register (VDFLDT2) Field Values	B-485
B-352	Video Display Threshold Register (VDTHRLD) Field Values	B-487
B-353	Video Display Horizontal Synchronization Register (VDHSYNC) Field Values	B-488
B-354	Video Display Field 1 Vertical Synchronization Start Register (VDVSYNS1) Field Values	B-489
B-355	Video Display Field 1 Vertical Synchronization End Register (VDVSYNE1) Field Values	B-490
B-356	Video Display Field 2 Vertical Synchronization Start Register (VDVSYNS2) Field Values	B-491
B-357	Video Display Field 2 Vertical Synchronization End Register (VDVSYNE2) Field Values	B-492
B-358	Video Display Counter Reload Register (VDRELOAD) Field Values	B-493
B-359	Video Display Display Event Register (VDDISPEVT) Field Values	B-494
B-360	Video Display Clipping Register (VDCLIP) Field Values	B-495

B-361	Video Display Default Display Value Register (VDDEFVAL) Field Values	B-497
B-362	Video Display Vertical Interrupt Register (VDVINT) Field Values	B-498
B-363	Video Display Field Bit Register (VDFBIT) Field Values	B-500
B-364	Video Display Field 1 Vertical Blanking Bit Register (VDVBIT1) Field Values	B-501
B-365	Video Display Field 2 Vertical Blanking Bit Register (VDVBIT2) Field Values	B-503
B-366	Video Port GPIO Registers	B-504
B-367	Video Port Peripheral Identification Register (VPPID) Field Values	B-505
B-368	Video Port Peripheral Control Register (PCR) Field Values	B-507
B-369	Video Port Pin Function Register (PFUNC) Field Values	B-508
B-370	Video Port Pin Direction Register (PDIR) Field Values	B-510
B-371	Video Port Pin Data Input Register (PDIN) Field Values	B-514
B-372	Video Port Pin Data Out Register (PDOUT) Field Values	B-516
B-373	Video Port Pin Data Set Register (PDSET) Field Values	B-518
B-374	Video Port Pin Data Clear Register (PDCLR) Field Values	B-520
B-375	Video Port Pin Interrupt Enable Register (PIEN) Field Values	B-522
B-376	Video Port Pin Interrupt Polarity Register (PIPOL) Field Values	B-524
B-377	Video Port Pin Interrupt Status Register (PISTAT) Field Values	B-526
B-378	Video Port Pin Interrupt Clear Register (PICLR) Field Values	B-528
B-379	Expansion Bus Registers	B-529
B-380	Expansion Bus Global Control Register (XBGC) Field Values	B-530
B-381	Expansion Bus XCE Space Control Register (XCECTL) Field Values	B-531
B-382	Expansion Bus Host Port Interface Control Register (XBHC) Field Values	B-533
B-383	Expansion Bus Internal Master Address Register (XBIMA) Field Values	B-535
B-384	Expansion Bus External Address Register (XBEA) Field Values	B-535
B-385	Expansion Bus Data Register (XBD) Field Values	B-536
B-386	Expansion Bus Internal Slave Address Register (XBISA) Field Values	B-536
C-1	CSL APIs for L2 Cache Operations	C-1
C-2	CSL APIs for L1 Cache Operations	C-2
C-3	Mapping of Old L2 Register Names to New L2 Register Names	C-2
C-4	Mapping of New L2ALLOCx Bit Field Names to Old Bit Field Names (C64x only)	C-3

CSL Overview

This chapter provides an overview of the chip support library (CSL), shows which TMS320C6000™ devices support the various application programming interfaces (APIs), and lists each of the API modules.

Topic	Page
1.1 CSL Introduction	1-2
1.2 CSL Naming Conventions	1-5
1.3 CSL Data Types	1-6
1.4 CSL Functions	1-7
1.5 CSL Macros	1-9
1.6 CSL Symbolic Constant Values	1-12
1.7 Resource Management	1-13
1.8 CSL API Module Support	1-15

1.1 CSL Introduction

The chip support library (CSL) provides a C-language interface for configuring and controlling on-chip peripherals. It consists of discrete modules that are built and archived into a library file. Each module relates to a single peripheral with the exception of several modules that provide general programming support, such as the interrupt request (IRQ) module which contains APIs for interrupt management, and the CHIP module which allows the global setting of the chip.

1.1.1 Benefits of the CSL

The benefits of the CSL include peripheral ease of use, shortened development time, portability, hardware abstraction, and a level of standardization and compatibility among devices. Specifically, the CSL offers:

- Standard Protocol-to-Program Peripherals

The CSL provides a standard protocol for programming the on-chip peripherals. This includes data types and macros to define a peripheral's configuration, and functions to implement the various operations of each peripheral.

- Basic Resource Management

Basic resource management is provided through the use of Open and Close functions for many of the peripherals. This is especially helpful for peripherals that support multiple channels.

- Symbolic Peripheral Descriptions

As a side benefit to the creation of the CSL, a complete symbolic description of all peripheral registers and register fields has been created. You will find it advantageous to use the higher-level protocols described in the first two benefits, because these are less device-specific, thus making it easier to migrate your code to newer versions of TI DSPs.

The symbolic constants used to program any peripheral are listed in its peripheral reference guide among the register descriptions.

1.1.2 CSL Architecture

The CSL granularity is designed such that each peripheral is covered by a single API module. Hence, there is a direct memory access (DMA) API module for the DMA peripheral, a multichannel buffered serial port (McBSP) API module for the McBSP peripheral, and so on.

Figure 1–1 illustrates some of the individual API modules (see section 1.8 for a complete list). This architecture allows for future expansion of the CSL because new API modules can be added as new peripheral devices emerge.

Figure 1–1. API Module Architecture

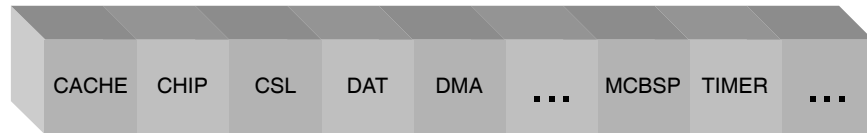

It is important to note that **not all** devices support **all** API modules. This depends on if the device actually has the peripheral to which an API relates. For example, the enhanced direct memory access (EDMA) API module is not supported on a C6201 because this device does not have an EDMA peripheral. Other modules such as the interrupt request (IRQ) module, however, are supported on all devices.

Table 1–1 lists general and peripheral modules with their associated include file and the module support symbol. These components must be included in your application.

Table 1–1. CSL Modules and Include Files

Peripheral Module (PER)	Description	Include File	Module Support Symbol†
CACHE	Cache module	csl_cache.h	CACHE_SUPPORT
CHIP	Chip-specific module	csl_chip.h	CHIP_SUPPORT
CSL	Top-level module	csl.h	NA
DAT	Device independent data copy/fill module	csl_dat.h	DAT_SUPPORT
DMA	Direct memory access module	csl_dma.h	DMA_SUPPORT
EMAC	Ethernet media access controller module	csl_emac.h	EMAC_SUPPORT
EDMA	Enhanced direct memory access module	csl_edma.h	EDMA_SUPPORT
EMIF	External memory interface module	csl_emif.h	EMIF_SUPPORT
EMIFA	External memory interface A module	csl_emifa.h	EMIFA_SUPPORT
EMIFB	External memory interface B module	csl_emifb.h	EMIFB_SUPPORT
GPIO	General-Purpose input/output module	csl_gpio.h	GPIO_SUPPORT

Peripheral Module (PER)	Description	Include File	Module Support Symbol [†]
HPI	Host port interface module	csl_hpi.h	HPI_SUPPORT
I2C	Inter-Integrated circuit module	csl_i2c.h	I2C_SUPPORT
IRQ	Interrupt controller module	csl_irq.h	IRQ_SUPPORT
McASP	Multichannel audio serial port module	csl_mcasp.h	MCASP_SUPPORT
McBSP	Multichannel buffered serial port module	csl_mcbasp.h	MCBSP_SUPPORT
MDIO	Management data I/O module	csl_mdio.h	MDIO_SUPPORT
PCI	Peripheral component interconnect interface module	csl_pci.h	PCI_SUPPORT
PWR	Power-down module	csl_pwr.h	PWR_SUPPORT
TCP	Turbo decoder coprocessor module	csl_tcp.h	TCP_SUPPORT
TIMER	Timer module	csl_timer.h	TIMER_SUPPORT
UTOP	Utopia interface module	csl_uto.h	UTOP_SUPPORT
VCP	Viterbi decoder coprocessor module	csl_vcp.h	VCP_SUPPORT
VIC	VCXO interpolated control	csl_vic.h	VIC_SUPPORT
VP	Video port module	csl_vp.h	VP_SUPPORT
XBUS	Expansion bus module	csl_xbus.h	XBUS_SUPPORT

[†] See definition in the related CSL module.

1.1.3 Interdependencies

Although each API module is unique, there exists some interdependency between the modules. For example, the DMA module depends on the IRQ module. This comes into play when linking code because if you use the DMA module, the IRQ module automatically gets linked also.

1.2 CSL Naming Conventions

Table 1–2 shows the conventions used when naming CSL functions, macros, and data types.

Table 1–2. CSL Naming Conventions

Object Type	Naming Convention
Function	PER_funcName()†
Variable	PER_varName†
Macro	PER_MACRO_NAME†
Typedef	PER_Typename†
Function Argument	funcArg
Structure Member	memberName

† PER is the placeholder for the module name.

- All functions, variables, macros, and data types start with PER_ (where PER is the module/peripheral name) in caps (uppercase letters)
- Function names follow the peripheral name and use all small (lower-case) letters. Capital letters are used only if the function name consists of two separate words, such as PER_getConfig()
- Macro names follow the peripheral name and use all caps, for example, DMA_PRICTL_RMK
- Data types start with uppercase letters followed by lowercase letters, such as DMA_Handle

Note: CSL Macro and Function Names

The CSL macro and constant names are defined for each register and each field in CSL include files. Therefore, you will need to be careful not to redefine macros using similar names.

Because many CSL functions are predefined in CSL libraries, you will need to name your own functions carefully.

1.3 CSL Data Types

The CSL provides its own set of data types. Table 1–3 lists the CSL data types as defined in the `stdinc.h` file.

Table 1–3. CSL Data Types

Data Type	Description
UInt8	unsigned char
UInt16	unsigned short
UInt32	unsigned int
UInt40	unsigned long
Int8	char
Int16	short
Int32	int
Int40	long

These data types are available to all CSL modules. Additional data types are defined within each module and are described by each module's chapter.

1.4 CSL Functions

Table 1–4 provides a generic description of the most common CSL functions where *PER* indicates a peripheral as listed in Table 1–1. Because not all of the functions are available for all the modules, specific descriptions and functions are listed in each module chapter.

The following conventions are used and are shown in Table 1–4.

- Italics indicate variable names.
- Brackets [...] indicate optional parameters.
 - *[handle]* is required only for the handle-based peripherals: DAT, DMA, EDMA, GPIO, McBSP, and TIMER. See section 1.7.1.
 - *[priority]* is required only for the DAT peripheral module.

Table 1–4. Generic CSL Functions

Function	Description
<pre>handle = PER_open(channelNumber, [priority] flags)</pre>	<p>Opens a peripheral channel and then performs the operation indicated by <i>flags</i>; must be called before using a channel. The return value is a unique device handle to use in subsequent API calls.</p> <p>The <i>priority</i> parameter applies only to the DAT module.</p>
<pre>PER_config([handle,] *configStructure)</pre>	<p>Writes the values of the configuration structure to the peripheral registers. You can initialize the configuration structure with:</p> <ul style="list-style-type: none"> <input type="checkbox"/> Integer constants <input type="checkbox"/> Integer variables <input type="checkbox"/> CSL symbolic constants, <i>PER_REG_DEFAULT</i> (See Section 1.6 CSL Symbolic Constant Values) <input type="checkbox"/> Merged field values created with the <i>PER_REG_RMK</i> macro
<pre>PER_configArgs([handle,] regval_1, . . . regval_n)</pre>	<p>Writes the individual values (<i>regval_n</i>) to the peripheral registers. These values can be any of the following:</p> <ul style="list-style-type: none"> <input type="checkbox"/> Integer constants <input type="checkbox"/> Integer variables <input type="checkbox"/> CSL symbolic constants, <i>PER_REG_DEFAULT</i> <input type="checkbox"/> Merged field values created with the <i>PER_REG_RMK</i> macro
<pre>PER_reset([handle])</pre>	<p>Resets the peripheral to its power-on default values.</p>
<pre>PER_close(handle)</pre>	<p>Closes a peripheral channel previously opened with <i>PER_open()</i>. The registers for the channel are set to their power-on defaults, and any pending interrupt is cleared.</p>

1.4.1 Peripheral Initialization via Registers

The CSL provides two types of functions for initializing the registers of a peripheral: `PER_config()` and `PER_configArgs()` (where *PER* is the peripheral as listed in Table 1–1).

- `PER_config()` initializes the control registers of the PER peripheral, where PER is one of the CSL modules. This function requires an address as its one parameter. The address specifies the location of a structure that represents the peripherals register values. The configuration structure data type is defined for each peripheral module that contains the `PER_config()` function. Example 1–1 shows an example of this method.

Example 1–1. Using `PER_config()` with the configuration structure `PER_Config`

```

PER_Config MyConfig = {
    reg0,
    reg1,
    ...
};
...
PER_config(&MyConfig);
    
```

- `PER_configArgs()` allows you to pass the individual register values as arguments to the function, which then writes those individual values to the register. Example 1–2 shows an example of this method.

You can use these two initialization functions interchangeably but you still need to generate the register values. To simplify the process of defining the values to write to the peripheral registers, the CSL provides the `PER_REG_RMK` (make) macros, which form merged values from a list of field arguments. Macros are discussed in Section 1.5, *CSL Macros*.

Example 1–2. Using `PER_configArgs`

```

PER_configArgs(reg0, reg1, ...);
    
```

1.5 CSL Macros

Table 1–5 provides a generic description of the most common CSL macros, where:

- PER* indicates a peripheral. (e.g., DMA)
- REG* indicates, if applicable, a register name (e.g., PRICTL0, AUXCTL)
- FIELD* indicates a field in a register (e.g., ESIZE)
- regval* indicates an integer constant, an integer variable, a symbolic constant (*PER_REG_DEFAULT*), or a merged field value created with the peripheral field make macro, *PER_FMK()*.
- fieldval* indicates an integer constant, integer variable, or symbolic constant (*PER_REG_FIELD_SYMVAL*) as explained in section 1.6); all field values are right justified
- x* indicates an integer constant, integer variable.
- sym* indicates a symbolic constant
- CSL also offers equivalent macros to those listed in Table 1–5, but instead of using *REG* to identify which channel the register belongs to, it uses the handle value. The handle value is returned by the *PER_open()* function (see section 1.7). These macros are shown in Table 1–6.

Each API chapter provides specific descriptions of the macros within that module. Page references to the macros in the hardware abstraction layer (Chapter 28, *Using the HAL Macros*), are provided for additional information.

Table 1–5. Generic CSL Macros

Macro	Description
<i>PER_REG_RMK</i> (<i>fieldval_n</i> , . . <i>fieldval_0</i>)	Creates a value to store in the peripheral register; <i>_RMK</i> macros make it easier to construct register values based on field values. The following rules apply to the <i>_RMK</i> macros: <input type="checkbox"/> Include only fields that are writable. <input type="checkbox"/> Specify field arguments as most-significant bit first. <input type="checkbox"/> Whether or not they are used, all writable field values must be included. <input type="checkbox"/> If you pass a field value exceeding the number of bits allowed for that particular field, the <i>_RMK</i> macro truncates that field value.
<i>PER_RGET</i> (<i>REG</i>)	Returns the value in the peripheral register.
<i>PER_RSET</i> (<i>REG</i> , <i>regval</i>)	Writes the value to the peripheral register.
<i>PER_FMK</i> (<i>REG</i> , <i>FIELD</i> , <i>fieldval</i>)	Creates a shifted version of <i>fieldval</i> that you could OR with the result of other <i>_FMK</i> macros to initialize register <i>REG</i> . This allows the user to initialize few fields in <i>REG</i> as an alternative to the <i>_RMK</i> macro, which requires that ALL register fields be initialized.
<i>PER_FGET</i> (<i>REG</i> , <i>FIELD</i>)	Returns the value of the specified <i>FIELD</i> in the peripheral register.
<i>PER_FSET</i> (<i>REG</i> , <i>FIELD</i> , <i>fieldval</i>)	Writes <i>fieldval</i> to the specified <i>FIELD</i> in the peripheral register.
<i>PER_REG_ADDR</i> (<i>REG</i>)	If applicable, gets the memory address (or subaddress) of the peripheral register <i>REG</i> .
<i>PER_FSETS</i> (<i>REG</i> , <i>FIELD</i> , <i>sym</i>)	Writes the symbol value to the specified field in the peripheral.
<i>PER_FMKS</i> (<i>REG</i> , <i>FIELD</i> , <i>sym</i>)	Creates a shifted version of the symbol value that you can OR with the result of other <i>_FMK/_FMKS</i> macros to initialize register <i>REG</i> . (See also <i>PER_FMK()</i> macro.)

Table 1–6. Generic CSL Handle-Based Macros

Macro	Description
<i>PER_ADDRH</i> (h, <i>REG</i>)	Returns the address of a memory-mapped register for a given handle.
<i>PER_RGETH</i> (h, <i>REG</i>)	Returns the value of a register for a given handle.
<i>PER_RSETH</i> (h, <i>REG</i> , x)	Sets the register value to x for a given handle.
<i>PER_FGETH</i> (h, <i>REG</i> , <i>FIELD</i>)	Returns the value of the field for a given handle.
<i>PER_FSETH</i> (h, <i>REG</i> , <i>FIELD</i> , x)	Sets the field value to x for a given handle.
<i>PER_FSETSH</i> (h, <i>REG</i> , <i>FIELD</i> , <i>SYM</i>)	Sets the field value to the symbol value for a given handle.

Handle-based CSL macros are applicable to the following peripherals:

- DMA
- EDMA
- GPIO
- McBSP
- TIMER
- I2C
- McASP
- VP

1.6 CSL Symbolic Constant Values

To facilitate initialization of values in your application code, the CSL provides symbolic constants for registers and writable field values as described in Table 1–7, where:

- PER* indicates a peripheral
- REG* indicates a peripheral register
- FIELD* indicates a field in the register
- SYMVAL* indicates the symbolic value of a register field

Each API chapter provides specific descriptions of the symbolic constants within that module. Page references to the constants in the hardware abstraction layer (Chapter 28, *Using the HAL Macros*), are provided for additional information.

Table 1–7. Generic CSL Symbolic Constants

(a) Constant Values for Registers

Constant	Description
<i>PER_REG_DEFAULT</i>	Default value for a register; corresponds to the register value after a reset or to 0 if a reset has no effect.

(b) Constant Values for Fields

Constant	Description
<i>PER_REG_FIELD_SYMVAL</i>	Symbolic constant to specify values for individual fields in the specified peripheral register. See the CSL Registers in Appendix B for the symbolic values.
<i>PER_REG_FIELD_DEFAULT</i>	Default value for a field; corresponds to the field value after a reset or to 0 if a reset has no effect.

1.7 Resource Management

CSL provides a limited set of functions that enable resource management for applications which may support multiple algorithms, such as two McBSP or two TIMERS, and may reuse the same type of peripheral device.

Resource management in CSL is achieved through API calls to the `PER_open()` and `PER_close()` functions. The `PER_open()` function normally takes a device number and a reset flag as the primary arguments and returns a pointer to a handle structure that contains information about which channel (DMA) or port (McBSP) was opened, then set “Allocate” flag defined in the handle structure to 1, meaning the channel or port is in use. When given a specific device number, the open function checks a global “allocate” flag to determine its availability. If the device/channel is available, then it returns a pointer to a predefined handle structure for this device. If the device has already been opened by another process, then an invalid handle is returned whose value is equal to the CSL symbolic constant, `INV`. Note that CSL does nothing other than return an invalid handle from `PER_open()`. You must use this to insure that no resource-usage conflicts occur. It is left to the user to check the value returned from the `PER_open()` function to guarantee that the resource has been allocated.

A device/channel may be freed for use by other processes by a call to `PER_close()`. `PER_close()` clears the allocate flag defined under the handle structure object and resets the device/channel.

All CSL modules that support multiple devices or channels, such as McBSP and DMA, require a device handle as a primary argument to most API functions. For these APIs, the definition of a `PER_Handle` object is required.

1.7.1 Using CSL Handles

Handles are required only for peripherals that have multiple channels or ports, such as DMA, EDMA, GPIO, McBSP, TIMER, I2C, and VP.

You obtain a handle by calling the `PER_open()` function. When you no longer need a particular channel, free those resources by calling the `PER_close()` function. The `PER_open()` and `PER_close()` functions ensure that you do not initialize the same channel more than once.

CSL handle objects are used to uniquely identify an open peripheral channel/port or device. Handle objects must be declared in the C source, and initialized by a call to a `PER_open()` function before calling any other API functions that require a handle object as an argument. `PER_open()` returns a value of “INV” if the resource is already allocated.

```
DMA_Handle myDma;  
/* Defines a DMA_Handle object, myDma */
```

Once defined, the CSL handle object is initialized by a call to `PER_open`.

```
.  
.  
myDma = DMA_open (DMA_CHA0, DMA_OPEN_RESET);  
/* Open DMA channel 0 */
```

The call to `DMA_open` initializes the handle, `myDma`. This handle can then be used in calls to other API functions.

```
if(myDma != INV) {  
DMA_start (myDma);           /* Begin transfer */  
.  
.  
DMA_close (myDma); }       /* Free DMA channel */
```

1.8 CSL API Module Support

Not all CSL API modules are supported on all devices. For example, the EDMA API module is not supported on the C6201 because the C6201 does not have EDMA hardware. When an API module is not supported, all of its header file information is conditionally compiled out, meaning the declarations will not exist. Because of this, calling an EDMA API function on devices not supporting EDMA will result in a compiler and/or linker error.

Note:

To build the program with the right library, the device support symbol must be set in the compiler option window. For example, if using C6201, the compiler option set in the preprocessor tab would be `-dCHIP_6201`.

Table 1–8 and Table 1–9 show which devices support the API modules.

Table 1–8. CSL API Module Support for TMS320C6000 Devices

Module	6201	6202	6203	6204	6205	6211	6701	6711	6712	6713	DA610
CACHE	X	X	X	X	X	X	X	X	X	X	X
CHIP	X	X	X	X	X	X	X	X	X	X	X
DAT	X	X	X	X	X	X	X	X	X	X	X
DMA	X	X	X	X	X		X				
EDMA						X		X	X	X	X
EMIF	X	X	X	X	X	X	X	X	X	X	X
GPIO										X	X
HPI	X					X	X	X		X	X
I2C										X	X
IRQ	X	X	X	X	X	X	X	X	X	X	X
McASP										X	X
McBSP	X	X	X	X	X	X	X	X	X	X	X
PCI					X						
PLL										X	X
PWR	X	X	X	X	X	X	X	X	X	X	X
TIMER	X	X	X	X	X	X	X	X	X	X	X
XBUS		X	X	X							

Table 1–9. CSL API Module Support for TMS320C641x and DM64x Devices

Module	6414	6415	6416	6410	6413	6418	DM642	DM641	DM640
CACHE	X	X	X	X	X	X	X	X	X
CHIP	X	X	X	X	X	X	X	X	X
DAT	X	X	X	X	X	X	X	X	X
DMA									
EDMA	X	X	X	X	X	X	X	X	X
EMAC							X	X	X
EMIFA	X	X	X	X	X	X	X	X	X
EMIFB	X	X	X						
EMU			X						
GPIO	X	X	X	X	X	X	X	X	X
HPI	X	X	X	X	X	X	X	X	
IRQ	X	X	X	X	X	X	X	X	X
McASP				X	X	X	X	X	X
McBSP	X	X	X	X	X	X	X	X	X
MDIO							X	X	X
PCI		X	X				X		
PWR	X	X	X	X	X	X	X	X	X
TCP			X						
TIMER	X	X	X	X	X	X	X	X	X
UTOP		X	X						
VCP			X			X			
VIC							X	X	X
VP							X	X	X

1.8.1 CSL Endianness/Device Support Library

Table 1–10. CSL Device Support Library Name and Symbol Conventions

Device	Little Endian Library	Big Endian Library	Device Support Symbol
C6201	csl6201.lib	csl6201e.lib	CHIP_6201
C6202	csl6202.lib	csl6202e.lib	CHIP_6202
C6203	csl6203.lib	csl6203e.lib	CHIP_6203
C6204	csl6204.lib	csl6204e.lib	CHIP_6204
C6205	csl6205.lib	csl6205e.lib	CHIP_6205
C6211	csl6211.lib	csl6211e.lib	CHIP_6211
C6701	csl6701.lib	csl6701e.lib	CHIP_6701
C6711	csl6711.lib	csl6711e.lib	CHIP_6711
C6712	csl6712.lib	csl6712e.lib	CHIP_6712
C6713	csl6713.lib	csl6713e.lib	CHIP_6713
C6414	csl6414.lib	csl6414e.lib	CHIP_6414
C6415	csl6415.lib	csl6415e.lib	CHIP_6415
C6416	csl6416.lib	csl6416e.lib	CHIP_6416
DA610	cslDA610.lib	cslDA610e.lib	CHIP_DA610
DM642	cslDM642.lib	cslDM642e.lib	CHIP_DM642
DM641	cslDM641.lib	cslDM641e.lib	CHIP_DM641
DM640	cslDM640.lib	cslDM640e.lib	CHIP_DM640
C6410	csl6410.lib	csl6410.lib	CHIP_6410
C6413	csl6413.lib	csl6413.lib	CHIP_6413
C6418	csl6418.lib	csl6418.lib	CHIP_6418

CACHE Module

This chapter describes the CACHE module, gives a description of the two CACHE architectures, lists the functions and macros within the module, and provides a CACHE API reference section.

Topic	Page
2.1 Overview	2-2
2.2 Macros	2-4
2.3 Functions	2-6

2.1 Overview

The CACHE module functions are used for managing data and program cache.

Currently, TMS320C6x devices use three cache architectures. The first type, as seen on the C620x device, provides program cache by disabling on-chip program RAM and turning it into cache. The second and third types, seen on C621x/C671x and C64x devices respectively, are the two-level (L2) cache architectures. For the differences between C621x/C671x and C64x cache architectures, refer to *SPRU610 TMS320C64x DSP Two Level Internal Memory Reference Guide*.

The CACHE module has APIs that are specific for the L2 cache and specific for the older program cache architecture. However, the API functions are callable on both types of platforms to make application code portable. On devices without L2, the L2-specific cache API calls do nothing but return immediately.

Table 2–1 shows the API functions within the CACHE module.

Table 2–1. CACHE APIs

Syntax	Type	Description	See page ...
CACHE_clean [†]	F	Cleans a specific cache region	2-6
CACHE_enableCaching	F	Enables caching for a specified block of address space	2-7
CACHE_flush [†]	F	Flushes a region of cache	2-9
CACHE_getL2Mode	F	Gets the L2 cache mode	2-19
CACHE_getL2SramSize	F	Returns current L2 size configured as SRAM	2-10
CACHE_invalidate [†]	F	Invalidates a region of cache	2-10
CACHE_invAllL1p	F	L1P invalidate all	2-11
CACHE_invL1d	F	L1D block invalidate (C64x only)	2-11
CACHE_invL1p	F	L1P block invalidate	2-12
CACHE_invL2	F	L2 block invalidate (C64x only)	2-13
CACHE_L1D_LINESIZE	C	A compile time constant whose value is the L1D line size.	2-14

Note: F = Function; C = Constant; M = Macro

[†] This API function is provided for backward compatibility. Users should use the new APIs.

[‡] Only for C6414, C6415, C6416 devices

Table 2–1. CACHE APIs (Continued)

Syntax	Type	Description	See page ...
CACHE_L1P_LINESIZE	C	A compile time constant whose value is the L1P line size.	2-14
CACHE_L2_LINESIZE	C	A compile time constant whose value is the L2 line size.	2-15
CACHE_reset	F	Resets cache to power-on default	2-15
CACHE_resetEMIFA	F	Resets the MAR registers dedicated to the EMIFA	2-15
CACHE_resetEMIFB [†]	F	Resets the MAR registers dedicated to the EMIFB	2-15
CACHE_resetL2Queue	F	Resets the queue length of a given queue to default value	2-16
CACHE_ROUND_TO_LINESIZE (CACHE,ELCNT,ELSIZE)	M	Rounds to cache line size	2-16
CACHE_setL2Mode	F	Sets L2 cache mode	2-17
CACHE_setL2Queue	F	Sets the queue length of a given L2 queue	2-20
CACHE_setPriL2Req	F	Sets the L2 requestor priority level	2-20
CACHE_setPccMode	F	Sets program cache mode	2-21
CACHE_SUPPORT	C	A compile time constant whose value is 1 if the device supports the CACHE module	2-21
CACHE_wait	F	Waits for completion of the last cache operation	2-21
CACHE_wbAII2	F	L2 writeback all	2-22
CACHE_wbInvL1d	F	L1D block writeback and invalidate	2-23
CACHE_wbInvAII2	F	L2 writeback and invalidate all	2-24
CACHE_wbInvL2	F	L2 block writeback and invalidate	2-25
CACHE_wbL2	F	L2 block writeback	2-26

Note: F = Function; C = Constant; M = Macro

[†] This API function is provided for backward compatibility. Users should use the new APIs.

[‡] Only for C6414, C6415, C6416 devices

2.2 Macros

There are two types of CACHE macros: those that access registers and fields, and those that construct register and field values.

Table 2–2 lists the CACHE macros that access registers and fields, and Table 2–3 lists the CACHE macros that construct register and field values. The macros themselves are found in Chapter 28, *Using the HAL Macros*.

CACHE macros are not handle-based.

Table 2–2. CACHE Macros that Access Registers and Fields

Macro	Description/Purpose	See page...
CACHE_ADDR(<REG>)	Register address	28-12
CACHE_RGET(<REG>)	Returns the value in the peripheral register	28-18
CACHE_RSET(<REG>,x)	Register set	28-20
CACHE_FGET(<REG>,<FIELD>)	Returns the value of the specified field in the peripheral register	28-13
CACHE_FSET(<REG>,<FIELD>,fieldval)	Writes <i>fieldval</i> to the specified field in the peripheral register	28-15
CACHE_FSETS(<REG>,<FIELD>,<SYM>)	Writes the symbol value to the specified field in the peripheral	28-17
CACHE_RGETA(addr,<REG>)	Gets register for a given address	28-19
CACHE_RSETA(addr,<REG>,x)	Sets register for a given address	28-20
CACHE_FGETA(addr,<REG>,<FIELD>)	Gets field for a given address	28-13
CACHE_FSETA(addr,<REG>,<FIELD>,fieldval)	Sets field for a given address	28-16
CACHE_FSETSA(addr,<REG>,<FIELD>,<SYM>)	Sets field symbolically for a given address	28-17

Table 2–3. CACHE Macros that Construct Register and Field Values

Macro	Description/Purpose	See page ...
CACHE_<REG>_DEFAULT	Register default value	28-21
CACHE_<REG>_RMK()	Register make	28-23
CACHE_<REG>_OF()	Register value of ...	28-22
CACHE_<REG>_<FIELD>_DEFAULT	Field default value	28-24
CACHE_FMK()	Field make	28-14
CACHE_FMKS()	Field make symbolically	28-15
CACHE_<REG>_<FIELD>_OF()	Field value of ...	28-24
CACHE_<REG>_<FIELD>_<SYM>	Field symbolic value	28-24

CACHE_clean

2.3 Functions

CACHE_clean *Cleans a range of L2 cache*

Note:

This function is provided for backward compatibility only. The user is strongly advised to use the new functions as shown in Appendix D.

Function	<pre>void CACHE_clean(CACHE_Region region, void *addr, Uint32 wordCnt);</pre>
Arguments	<p>region Specifies which cache region to clean; must be one of the following:</p> <ul style="list-style-type: none"><input type="checkbox"/> CACHE_L2<input type="checkbox"/> CACHE_L2ALL <p>addr Beginning address of range to clean; word aligned</p> <p>wordCnt Number of 32-bit words to clean. IMPORTANT: Maximum allowed wordCnt is 65535.</p>
Return Value	none
Description	<p>Cleans a range of L2 cache. All lines within the range defined by <code>addr</code> and <code>wordCnt</code> are cleaned out of L2. If <code>CACHE_L2ALL</code> is specified, then all of L2 is cleaned, <code>addr</code> and <code>wordCnt</code> are ignored. A clean operation involves writing back all dirty cache lines and then invalidating those lines. This routine waits until the operation completes before returning.</p> <p>Note: This function does nothing on devices without L2 cache.</p>
Example	<p>If you want to clean a 4K-byte range that starts at 0x80000000 out of L2, use:</p> <pre>CACHE_clean(CACHE_L2, (void*) 0x80000000, 0x00000400);</pre> <p>If you want to clean all lines out of L2 use:</p> <pre>CACHE_clean(CACHE_L2ALL, (void*) 0x00000000, 0x00000000);</pre>

CACHE_enableCaching *Specifies block of ext. memory for caching*

Function	void CACHE_enableCaching(Uint32 block);
Arguments	<p>block Specifies a block of external memory to enable caching for; must be one of the following:</p> <p>For devices other than C64x-</p> <ul style="list-style-type: none"> <input type="checkbox"/> CACHE_CE33 –(0xB3000000 to 0xB3FFFFFF) <input type="checkbox"/> CACHE_CE32 –(0xB2000000 to 0xB2FFFFFF) <input type="checkbox"/> CACHE_CE31 –(0xB1000000 to 0xB1FFFFFF) <input type="checkbox"/> CACHE_CE30 –(0xB0000000 to 0xB0FFFFFF) <input type="checkbox"/> CACHE_CE23 –(0xA3000000 to 0xA3FFFFFF) <input type="checkbox"/> CACHE_CE22 –(0xA2000000 to 0xA2FFFFFF) <input type="checkbox"/> CACHE_CE21 –(0xA1000000 to 0xA1FFFFFF) <input type="checkbox"/> CACHE_CE20 –(0xA0000000 to 0xA0FFFFFF) <input type="checkbox"/> CACHE_CE13 –(0x93000000 to 0x93FFFFFF) <input type="checkbox"/> CACHE_CE12 –(0x92000000 to 0x92FFFFFF) <input type="checkbox"/> CACHE_CE11 –(0x91000000 to 0x91FFFFFF) <input type="checkbox"/> CACHE_CE10 –(0x90000000 to 0x90FFFFFF) <input type="checkbox"/> CACHE_CE03 –(0x83000000 to 0x83FFFFFF) <input type="checkbox"/> CACHE_CE02 –(0x82000000 to 0x82FFFFFF) <input type="checkbox"/> CACHE_CE01 –(0x81000000 to 0x81FFFFFF) <input type="checkbox"/> CACHE_CE00 –(0x80000000 to 0x80FFFFFF) <p>For C6414, C6415, and C6416 EMIFB</p> <ul style="list-style-type: none"> <input type="checkbox"/> CACHE_EMIFB_CE00 –(60000000h to 60FFFFFFh) <input type="checkbox"/> CACHE_EMIFB_CE01 –(61000000h to 61FFFFFFh) <input type="checkbox"/> CACHE_EMIFB_CE02 –(62000000h to 62FFFFFFh) <input type="checkbox"/> CACHE_EMIFB_CE03 –(63000000h to 63FFFFFFh) <input type="checkbox"/> CACHE_EMIFB_CE010 –(64000000h to 64FFFFFFh) <input type="checkbox"/> CACHE_EMIFB_CE011 –(65000000h to 65FFFFFFh) <input type="checkbox"/> CACHE_EMIFB_CE012 –(66000000h to 66FFFFFFh) <input type="checkbox"/> CACHE_EMIFB_CE013 –(67000000h to 67FFFFFFh) <input type="checkbox"/> CACHE_EMIFB_CE020 –(68000000h to 68FFFFFFh) <input type="checkbox"/> CACHE_EMIFB_CE021 –(69000000h to 69FFFFFFh) <input type="checkbox"/> CACHE_EMIFB_CE022 –(6A000000h to 6AFFFFFFh) <input type="checkbox"/> CACHE_EMIFB_CE023 –(6B000000h to 6BFFFFFFh) <input type="checkbox"/> CACHE_EMIFB_CE030 –(6C000000h to 6CFFFFFFh) <input type="checkbox"/> CACHE_EMIFB_CE031 –(6D000000h to 6DFFFFFFh) <input type="checkbox"/> CACHE_EMIFB_CE032 –(6E000000h to 6EFFFFFFh) <input type="checkbox"/> CACHE_EMIFB_CE033 –(6F000000h to 6FFFFFFFh)

CACHE_enableCaching

For EMIFA CE0–

- CACHE_EMIFA_CE0 –(80000000h to 80FFFFFFh)
- CACHE_EMIFA_CE01 –(81000000h to 81FFFFFFh)
- CACHE_EMIFA_CE02 –(82000000h to 82FFFFFFh)
- CACHE_EMIFA_CE03 –(83000000h to 83FFFFFFh)
- CACHE_EMIFA_CE04 –(84000000h to 84FFFFFFh)
- CACHE_EMIFA_CE05 –(85000000h to 85FFFFFFh)
- CACHE_EMIFA_CE06 –(86000000h to 86FFFFFFh)
- CACHE_EMIFA_CE07 –(87000000h to 87FFFFFFh)
- CACHE_EMIFA_CE08 –(88000000h to 88FFFFFFh)
- CACHE_EMIFA_CE09 –(89000000h to 89FFFFFFh)
- CACHE_EMIFA_CE010 –(8A000000h to 8AFFFFFFh)
- CACHE_EMIFA_CE011 –(8B000000h to 8BFFFFFFh)
- CACHE_EMIFA_CE012 –(8C000000h to 8CFFFFFFh)
- CACHE_EMIFA_CE013 –(8D000000h to 8DFFFFFFh)
- CACHE_EMIFA_CE014 –(8E000000h to 8EFFFFFFh)
- CACHE_EMIFA_CE015 –(8F000000h to 8FFFFFFFh)

For CACHE_EMIFA_CE1, CACHE_EMIFA_CE2, and CACHE_EMIFA_CE3 the symbols are the same as CACHE_EMIFA_CE0, with start addresses 90000000h, A0000000h, and B0000000h, respectively.

Return Value

none

Description

Enables caching for the specified block of memory. This is accomplished by setting the CE bit in the appropriate memory attribute register (MAR). By default, caching is disabled for all memory spaces.

Note: This function does nothing on devices without L2 cache.

Example

To enable caching for the range of memory from 0x80000000 to 0x80FFFFFF use:

For C64x –

```
CACHE_enableCaching(CACHE_EMIFA_CE00);
```

For other devices –

```
CACHE_enableCaching(CACHE_CE00);
```

CACHE_flush

Flushes region of cache (obsolete)

Note:

This function is provided for backward compatibility only. The user is strongly advised to use the new functions as shown in Appendix D.

Function

```
void CACHE_flush(
    CACHE_Region region,
    void *addr,
    Uint32 wordCnt
);
```

Arguments

region Specifies which cache region to flush from; must be one of the following:

- CACHE_L2
- CACHE_L2ALL
- CACHE_L1D

addr Beginning address of range to flush; word aligned

wordCnt Number of 32-bit words to flush. **IMPORTANT:** Maximum allowed wordCnt is 65535.

Return Value

none

Description

Flushes a range of L2 cache. All lines within the range defined by `addr` and `wordCnt` are flushed out of L2. If `CACHE_L2ALL` is specified, then all of L2 is flushed; `addr` and `wordCnt` are ignored. A flush operation involves writing back all dirty cache lines, but the lines are not invalidated. This routine waits until the operation completes before returning.

Note: This function does nothing on devices without L2 cache.

Example

If you want to flush a 4K-byte range that starts at 0x80000000 out of L2, use:

```
CACHE_flush(CACHE_L2, (void*)0x80000000, 0x00000400);
```

If you want to flush all lines out of L2, use:

```
CACHE_flush(CACHE_L2ALL, (void*)0x00000000, 0x00000000);
```

CACHE_getL2SramSize

CACHE_getL2SramSize *Returns current size of L2 that is configured as SRAM*

Function `UInt32 CACHE_getL2SramSize();`

Arguments `none`

Return Value `size` Returns number of bytes of on-chip SRAM

Description This function returns the current size of L2 that is configured as SRAM.
Note: This function does nothing on devices without L2 cache.

Example `SramSize = CACHE_getL2SramSize();`

CACHE_invalidate *Invalidates a region of cache (obsolete)*

Note:

This function is provided for backward compatibility only. The user is strongly advised to use the new functions as shown in Appendix D.

Function `void CACHE_invalidate(
 CACHE_Region region,
 void *addr,
 UInt32 wordCnt
);`

Arguments `region` Specifies which cache region to invalidate; must be one of the following:
 `CACHE_L1P` Invalidate L1P
 `CACHE_L1PALL` Invalidate all of L1P
 `CACHE_L1DALL` Invalidate all of L1D

`addr` Beginning address of range to invalidate; word aligned

`wordCnt` Number of 32-bit words to invalidate. IMPORTANT: Maximum allowed `wordCnt` is 65535.

Return Value `none`

Description Invalidates a range from cache. All lines within the range defined by `addr` and `wordCnt` are invalidated from `region`. If `CACHE_L1PALL` is specified, then all of L1P is invalidated; `addr` and `wordCnt` are ignored. Likewise, if `CACHE_L1DALL` is specified, then all of L1D is invalidated; `addr` and `wordCnt` are ignored. This routine waits until the operation completes before returning.

Note: This function does nothing on devices without L2 cache.

Example

If you want to invalidate a 4K-byte range that starts at 0x80000000 from L1P, use:

```
CACHE_invalidate(CACHE_L1P, (void*)0x80000000, 0x00000400);
```

If you want to invalidate all lines from L1D, use:

```
CACHE_invalidate(CACHE_L1DALL, (void*)0x00000000, 0x00000000);
```

CACHE_invAllL1p *L1P invalidates all*

Function

```
void CACHE_invAllL1p();
```

Arguments

none

Return Value

none

Description

This function issues an L1P invalidate all command to the cache controller. Please see the *TMS320C621x/C671x DSP Two Level Internal Memory Reference Guide* (literature number SPRU609) and the *TMS320C64x DSP Two Level Internal Memory Reference Guide* (literature number SPRU610) for details of this operation.

Example

```
CACHE_invAllL1p();
```

CACHE_invL1d *L1D block invalidate (C64x only)*

Function

```
void CACHE_invL1d(
    void      *blockPtr,
    Uint32    byteCnt,
    int       wait
);
```

Arguments

- blockPtr Pointer to the beginning of the block

- byteCnt Number of bytes in the block. This value must be a multiple of four. The largest size this can be in 65535*4.

- wait Wait flag:
 - CACHE_NOWAIT – return immediately
 - CACHE_WAIT – wait until the operation completes

Return Value

none

CACHE_invL1p

Description

This function issues an L1D block invalidate command to the cache controller. Please see the *TMS320C64x DSP Two Level Internal Memory Reference Guide* (literature number SPRU610) for details of this operation. If a previous cache operation is still active, the function waits for its completion before initiating the new operation, in order to prevent lockout of interrupts.

If the user specifies `CACHE_NOWAIT`, then the function returns immediately, regardless of whether the operation has completed. The user can call `CACHE_wait()` afterwards to wait for the operation to complete.

Although the block size can be specified in number of bytes, the cache controller operates on whole cache lines only.

This function is only supported on C64x devices.

Example

```
char buffer[1024];
/* call with wait flag set */
CACHE_invL1d(buffer, 1024, CACHE_WAIT);
...
/* call without the wait flag set */
CACHE_invL1d(buffer, 1024, CACHE_NOWAIT);
...
...
CACHE_wait();
```

CACHE_invL1p

L1P block invalidate

Function

```
void CACHE_invL1p(
    void      *blockPtr,
    Uint32    byteCnt,
    int       wait
);
```

Arguments

`blockPtr` Pointer to the beginning of the block

`byteCnt` Number of bytes in the block. This value must be a multiple of four. The largest size this can be in 65535×4 .

`wait` Wait flag:

- `CACHE_NOWAIT` – return immediately
- `CACHE_WAIT` – wait until the operation completes

Return Value

none

Description This function issues an L1P block invalidate command to the cache controller. Please see the *TMS320C621x/C671x DSP Two Level Internal Memory Reference Guide* (literature number SPRU609) and the *TMS320C64x DSP Two Level Internal Memory Reference Guide* (literature number SPRU610) for details of this operation. If a previous cache operation is still active, the function waits for its completion before initiating the new operation, in order to prevent lockout of interrupts.

If the user specifies `CACHE_NOWAIT`, then the function returns immediately, regardless of whether the operation has completed. The user can call `CACHE_wait()` afterwards to wait for the operation to complete.

Although the block size can be specified in number of bytes, the cache controller operates on whole cache lines only.

Example

```
char buffer[1024];
/* call with wait flag set */
CACHE_invL1p(buffer, 1024, CACHE_WAIT);
...
/* call without the wait flag set */
CACHE_invL1p(buffer, 1024, CACHE_NOWAIT);
...
...
CACHE_wait();
```

CACHE_invL2 *L2 block invalidate (C64x devices only)*

Function void `CACHE_invL2`(
 void *blockPtr,
 Uint32 byteCnt,
 int wait
);

Arguments

`blockPtr` Pointer to the beginning of the block

`byteCnt` Number of bytes in the block. This value must be a multiple of four. The largest size this can be in 65535*4.

`wait` Wait flag:
 `CACHE_NOWAIT` – return immediately
 `CACHE_WAIT` – wait until the operation completes

Return Value none

CACHE_L1D_LINESIZE

Description This function issues an L2 block invalidate command to the cache controller. Please see the *TMS320C64x DSP Two Level Internal Memory Reference Guide* (literature number SPRU610) for details of this operation. If a previous cache operation is still active, the function waits for its completion before initiating the new operation, in order to prevent lockout of interrupts.

If the user specifies `CACHE_NOWAIT`, then the function returns immediately, regardless of whether the operation has completed. The user can call `CACHE_wait()` afterwards to wait for the operation to complete.

Although the block size can be specified in number of bytes, the cache controller operates on whole cache lines only. To prevent unintended behavior, `blockPtr` and `byteCnt` should be multiples of the cache line size.

This function is supported on C64x devices only.

Example

```
char buffer[1024];
/* call with wait flag set */
CACHE_invL2(buffer, 1024, CACHE_WAIT);
...
/* call without the wait flag set */
CACHE_invL2(buffer, 1024, CACHE_NOWAIT);
...
...
CACHE_wait();
```

CACHE_L1D_LINESIZE *L1D line size*

Constant `CACHE_L1D_LINESIZE`

Description Compile-time constant that is set equal to the L1D cache line size of the device.

Example `#pragma DATA_ALIGN(array, CACHE_L1D_LINESIZE)`

CACHE_L1P_LINESIZE *L1P line size*

Constant `CACHE_L1P_LINESIZE`

Description Compile-time constant that is set equal to the L1P cache line size of the device.

Example `#pragma DATA_ALIGN(array, CACHE_L1P_LINESIZE)`

CACHE_L2_LINESIZE *L2 line size*

Constant	CACHE_L2_LINESIZE
Description	Compile-time constant that is set equal to the L2 cache line size of the device.
Example	<code>#pragma DATA_ALIGN(array, CACHE_L2_LINESIZE)</code>

CACHE_reset *Resets cache to power-on default*

Function	<code>void CACHE_reset();</code>
Arguments	none
Return Value	none
Description	Resets cache to power-on default. Devices with L2 Cache: All MAR bits are cleared Devices without L2 Cache: PCC field of CSR set to zero (mapped) Note: If you reset the cache, any dirty data will be lost. If you want to preserve this data, flush it out first.
Example	<code>CACHE_reset();</code>

CACHE_resetEMIFA *Resets the MAR registers dedicated to the EMIFA CE spaces*

Function	<code>void CACHE_resetEMIFA();</code>
Arguments	none
Return Value	none
Description	This function resets the MAR registers dedicated to the EMIFA CE spaces.
Example	<code>CACHE_enableCaching(CACHE_EMIFA_CE00);</code> <code>CACHE_enableCaching(CACHE_EMIFA_CE13);</code> <code>CACHE_resetEMIFA();</code>

CACHE_resetEMIFB *Resets the MAR registers dedicated to the EMIFB CE spaces*

Function	<code>void CACHE_resetEMIFB();</code>
Arguments	none
Return Value	none
Description	This function resets all the MAR registers dedicated to the EMIFB CE spaces. This is defined only for C6414, C6415 and C6416 devices.
Example	<code>CACHE_enableCaching(CACHE_EMIFB_CE00);</code> <code>CACHE_enableCaching(CACHE_EMIFB_CE13);</code> <code>CACHE_resetEMIFB();</code>

CACHE_resetL2Queue

CACHE_resetL2Queue *Resets the queue length of the L2 queue to its default value*

Function	<code>void CACHE_resetL2Queue(Uint32 queueNum);</code>
Arguments	queueNum Queue number to be reset to the default length: The following constants may be used for L2 queue number: <ul style="list-style-type: none"><input type="checkbox"/> CACHE_L2Q0<input type="checkbox"/> CACHE_L2Q1<input type="checkbox"/> CACHE_L2Q2<input type="checkbox"/> CACHE_L2Q3
Return Value	none
Description	This functions allows the user to reset the queue length of the given L2 queue to its default value. See the <code>CACHE_setL2Queue()</code> function.
Example	<pre>EDMA_setL2Queue(CACHE_L2Q2, 4); EDMA_resetL2Queue(CACHE_L2Q2);</pre>

CACHE_ROUND_TO_LINESIZE *Rounds to cache line size*

Macro	<code>CACHE_ROUND_TO_LINESIZE(CACHE, ELCNT, ELSIZE);</code>
Arguments	CACHE Cache type: L1D, L1P, or L2 ELCNT Element count ELSIZE Element size
Return Value	Rounded up element count
Description	This macro rounds an element up to make an array size a multiple number of cache lines. Arrays located in external memory that require user-controlled coherence maintenance must be aligned at a cache line boundary and be a multiple of cache lines large to prevent incoherency problems. Please see the <i>TMS320C6000 DSP Cache User's Guide</i> (literature number SPRU656) for details.

Example

```

/* assume an L2 line size of 128 bytes */
/* align arrays y and x at the cache line border */
#pragma DATA_ALIGN(y, CACHE_L2_LINESIZE)
#pragma DATA_ALIGN(x, CACHE_L2_LINESIZE)
/* array y spans 7 full lines and 104 bytes of the next line*/
short y[500];
/* the array element count is increased such that the array x
   spans a multiple number of cache lines, i.e. 8 lines */
short x[CACHE_ROUND_TO_LINESIZE(L2, 500, sizeof(short))]

```

CACHE_setL2Mode *Sets L2 cache mode*

Function

```

CACHE_L2Mode CACHE_setL2Mode(
    CACHE_L2Mode newMode
);

```

Arguments

newMode New L2 cache mode; must be one of the following:

(For C6711/C6211)

- CACHE_64KSRAM
- CACHE_0KCACHE
- CACHE_48KSRAM
- CACHE_16KCACHE
- CACHE_32KSRAM
- CACHE_32KCACHE
- CACHE_16KSRAM
- CACHE_48KCACHE
- CACHE_0KSRAM
- CACHE_64KCACHE

(For C6713 and DA610)

- CACHE_256KSRAM
- CACHE_0KCACHE
- CACHE_240KSRAM
- CACHE_16KCACHE
- CACHE_224KSRAM
- CACHE_32KCACHE
- CACHE_208KSRAM
- CACHE_48KCACHE
- CACHE_192KSRAM
- CACHE_64KCACHE

CACHE_setL2Mode

(For C6414/C6415/C6416)

- CACHE_1024KSRAM
- CACHE_0KCACHE
- CACHE_992KSRAM
- CACHE_32KCACHE
- CACHE_960KSRAM
- CACHE_64KCACHE
- CACHE_896KSRAM
- CACHE_128KCACHE
- CACHE_768KSRAM
- CACHE_256KCACHE

(For C6410, DM640 and DM641)

- CACHE_128KSRAM
- CACHE_0KCACHE
- CACHE_96KSRAM
- CACHE_32KCACHE
- CACHE_64KSRAM
- CACHE_64KCACHE
- CACHE_128KCACHE

(For C6413)

- CACHE_256KSRAM
- CACHE_0KCACHE
- CACHE_224KSRAM
- CACHE_32KCACHE
- CACHE_192KSRAM
- CACHE_64KSRAM
- CACHE_128KSRAM
- CACHE_128KCACHE
- CACHE_256KCACHE

(For C6418)

- CACHE_512KSRAM
- CACHE_0KCACHE
- CACHE_480KSRAM
- CACHE_32KCACHE
- CACHE_448KSRAM
- CACHE_64KCACHE
- CACHE_384KSRAM
- CACHE_128KCACHE
- CACHE_256KSRAM

CACHE_256KCACHE

(For DM642)

- CACHE_256KSRAM
- CACHE_0KCACHE
- CACHE_224KSRAM
- CACHE_32KCACHE
- CACHE_192KSRAM
- CACHE_64KCACHE
- CACHE_128KSRAM
- CACHE_128KCACHE
- CACHE_0KSRAM
- CACHE_256KCACHE

Return Value oldMode Returns old cache mode, one of those listed above.

Description This function sets the mode of the L2 cache. There are three conditions that may occur as a result of changing cache modes:

1. A decrease in cache size
2. An increase in cache size
3. No change in cache size

If the cache size decreases, all of L2 is writeback-invalidated, then the mode is changed. If the cache size increases, the part of SRAM that is about to be turned into cache is writeback-invalidated from L1D and all of L2 is writeback-invalidated; then the mode is changed. Nothing happens when there is no change.

Increasing cache size means that some of the SRAM is lost. If there is data in the SRAM that should not be lost, it must be preserved before changing cache modes. Some of the cache modes are identical. For example, on the C6211, there are 64KBytes of L2; hence, CACHE_16KSRAM is equivalent to CACHE_48KCACHE. However, if the L2 size changes on a future device, this will not be the case. Note: This function does nothing on devices without L2 cache.

Example `CACHE_L2Mode OldMode;`
 `OldMode = CACHE_setL2Mode(CACHE_32KCACHE);`

CACHE_getL2Mode *Returns Level 2 Cache mode*

Function `voide CACHE_getL2Mode();`

Arguments None

CACHE_setL2Queue

Return Value	Leve 2 Cache mode (listed under CACHE_setL2Mode function explanation)
Description	This returns the current L2 cache mode. If L2 cache is not supported, it returns CACHE_0KCACHE.
Example	<pre>CACHE_L2Mode oldMode; OldMode = CACHE_getL2Mode();</pre>

CACHE_setL2Queue *Sets the queue length of the L2 queue*

Function	<pre>void CACHE_setL2Queue(Uint32 queueNum; Uint32 length);</pre>				
Arguments	<table><tr><td>queueNum</td><td>Queue number to be set. The following constants may be used for L2 queue number:<ul style="list-style-type: none"><input type="checkbox"/> CACHE_L2Q0<input type="checkbox"/> CACHE_L2Q1<input type="checkbox"/> CACHE_L2Q2<input type="checkbox"/> CACHE_L2Q3</td></tr><tr><td>length</td><td>Queue length to be set</td></tr></table>	queueNum	Queue number to be set. The following constants may be used for L2 queue number: <ul style="list-style-type: none"><input type="checkbox"/> CACHE_L2Q0<input type="checkbox"/> CACHE_L2Q1<input type="checkbox"/> CACHE_L2Q2<input type="checkbox"/> CACHE_L2Q3	length	Queue length to be set
queueNum	Queue number to be set. The following constants may be used for L2 queue number: <ul style="list-style-type: none"><input type="checkbox"/> CACHE_L2Q0<input type="checkbox"/> CACHE_L2Q1<input type="checkbox"/> CACHE_L2Q2<input type="checkbox"/> CACHE_L2Q3				
length	Queue length to be set				
Return Value	none				
Description	This function allows the user to set the queue length of a specified L2 also CACHE_resetL2Queue() function.				
Example	<pre>CACHE_setL2Queue(CACHE_L2Q1, 5);</pre>				

CACHE_setPriL2Req *Sets the L2 priority level "P" of the CCFG register*

Function	<pre>void CACHE_setPriL2Req(Uint32 priority);</pre>		
Arguments	<table><tr><td>priority</td><td>Priority request level to be set. The following constants may be used:<ul style="list-style-type: none"><input type="checkbox"/> CACHE_L2PRIURG (0)<input type="checkbox"/> CACHE_L2PRIHIGH (1)<input type="checkbox"/> CACHE_L2PRIMED (2)<input type="checkbox"/> CACHE_L2PRILOW (3)</td></tr></table>	priority	Priority request level to be set. The following constants may be used: <ul style="list-style-type: none"><input type="checkbox"/> CACHE_L2PRIURG (0)<input type="checkbox"/> CACHE_L2PRIHIGH (1)<input type="checkbox"/> CACHE_L2PRIMED (2)<input type="checkbox"/> CACHE_L2PRILOW (3)
priority	Priority request level to be set. The following constants may be used: <ul style="list-style-type: none"><input type="checkbox"/> CACHE_L2PRIURG (0)<input type="checkbox"/> CACHE_L2PRIHIGH (1)<input type="checkbox"/> CACHE_L2PRIMED (2)<input type="checkbox"/> CACHE_L2PRILOW (3)		

Return Value none

Description This function allows the user to set the L2 priority level “P” of the CCFG register.

Example `CACHE_setPriL2Req(CACHE_L2PRIHIGH);`

CACHE_setPccMode *Sets program cache mode*

Function `CACHE_Pcc CACHE_setPccMode(CACHE_Pcc newMode);`

Arguments newMode New program cache mode; must be one of the following:
 CACHE_PCC_MAPPED
 CACHE_PCC_ENABLE

Return Value OldMode Returns the old program cache mode; will be one of the following:
 CACHE_PCC_MAPPED
 CACHE_PCC_ENABLE

Description This function sets the program cache mode for devices that do not have an L2 cache. For devices that do have an L2 cache such as the C6211, this function does nothing. See the *TMS320C6000 Peripherals Reference Guide* (SPRU190) for the meaning of the cache modes.

Example To enable the program cache in normal mode, use:
`CACHE_Pcc OldMode;`
`OldMode = CACHE_setPccMode(CACHE_PCC_ENABLE);`

CACHE_SUPPORT *Compile time constant*

Constant CACHE_SUPPORT

Description Compile time constant that has a value of 1 if the device supports the CACHE module and 0 otherwise. You are not required to use this constant.
 Currently, all devices support this module.

Example `#if (CACHE_SUPPORT)`
`/* user cache configuration */`
`#endif`

CACHE_wait *Waits for completion of the last cache operation*

Function `int CACHE_wait();`

Arguments none

CACHE_wbAII2

Return Value none

Description This function waits for the completion of the last cache operation. This function ONLY works in conjunction with the following operations:

- CACHE_wbL2()
- CACHE_invL2()
- CACHE_wbInvL2()
- CACHE_wbAII2()
- CACHE_wbInvAII2()
- CACHE_invL1d()
- CACHE_wbInvL1d()
- CACHE_invL1p()

Example

```
CACHE_wbInvAII2(CACHE_NOWAIT);  
...  
...  
CACHE_wait();
```

CACHE_wbAII2 L2 writeback all

Function void CACHE_wbAII2(
int wait
);

Arguments wait Wait flag:
 CACHE_NOWAIT – return immediately
 CACHE_WAIT – wait until the operation completes

Return Value none

Description This function issues an L2 writeback all command to the cache controller. Please see the *TMS320C621x/C671x DSP Two Level Internal Memory Reference Guide* (literature number SPRU609) and the *TMS320C64x DSP Two Level Internal Memory Reference Guide* (literature number SPRU610) for details of this operation.

If the user specifies CACHE_NOWAIT, then the function returns immediately, regardless of whether the operation has completed. The user can call CACHE_wait() afterwards to wait for the operation to complete.

Example

```

/* call with wait flag set */
CACHE_wbAllL2(CACHE_WAIT);
...
/* call without the wait flag set */
CACHE_wbAllL2(CACHE_NOWAIT);
...
CACHE_wait();

```

CACHE_wbInvL1d *L1D block writeback and invalidate*

Function

```

void CACHE_wbInvL1d(
    void      *blockPtr,
    Uint32    byteCnt,
    int       wait
);

```

Arguments

blockPtr Pointer to the beginning of the block

byteCnt Number of bytes in the block. This value must be a multiple of four. The largest size this can be in 65535*4.

wait Wait flag:

- CACHE_NOWAIT – return immediately
- CACHE_WAIT – wait until the operation completes

Return Value none

Description

This function issues an L1D block writeback and invalidate command to the cache controller. Please see the *TMS320C621x/C671x DSP Two Level Internal Memory Reference Guide* (literature number SPRU609) and the *TMS320C64x DSP Two Level Internal Memory Reference Guide* (literature number SPRU610) for details of this operation. If a previous cache operation is still active, the function waits for its completion before initiating the new operation, in order to prevent lockout of interrupts.

If the user specifies CACHE_NOWAIT, then the function returns immediately, regardless of whether the operation has completed. The user can call CACHE_wait() afterwards to wait for the operation to complete.

Although the block size can be specified in number of bytes, the cache controller operates on whole cache lines only.

CACHE_wbInvAllL2

Example

```
char buffer[1024];
/* call with wait flag set */
CACHE_wbInvL1d(buffer, 1024, CACHE_WAIT);
...
/* call without the wait flag set */
CACHE_wbInvL1d(buffer, 1024, CACHE_NOWAIT);
...
...
CACHE_wait();
```

CACHE_wbInvAllL2 L2 writeback and invalidate all

Function

```
void CACHE_wbInvAllL2(
    int    wait
);
```

Arguments

wait Wait flag:

- CACHE_NOWAIT – return immediately
- CACHE_WAIT – wait until the operation completes

Return Value

none

Description

This function issues an L2 writeback and invalidate all command to the cache controller. Please see the *TMS320C621x/C671x DSP Two Level Internal Memory Reference Guide* (literature number SPRU609) and the *TMS320C64x DSP Two Level Internal Memory Reference Guide* (literature number SPRU610) for details of this operation.

If the user specifies CACHE_NOWAIT, then the function returns immediately, regardless of whether the operation has completed. The user can call CACHE_wait() afterwards to wait for the operation to complete.

Example

```
/* call with wait flag set */
CACHE_wbInvAllL2(CACHE_WAIT);
...
/* call without the wait flag set */
CACHE_wbInvAllL2(CACHE_NOWAIT);
...
...
CACHE_wait();
```

CACHE_wbInvL2 *L2 block writeback and invalidate*

Function	void CACHE_wbInvL2(void *blockPtr, Uint32 byteCnt, int wait);
Arguments	<p>blockPtr Pointer to the beginning of the block</p> <p>byteCnt Number of bytes in the block. This value must be a multiple of four. The largest size this can be in 65535*4.</p> <p>wait Wait flag: <input type="checkbox"/> CACHE_NOWAIT – return immediately <input type="checkbox"/> CACHE_WAIT – wait until the operation completes</p>
Return Value	none
Description	<p>This function issues an L2 block writeback and invalidate command to the cache controller. Please see the <i>TMS320C621x/C671x DSP Two Level Internal Memory Reference Guide</i> (literature number SPRU609) and the <i>TMS320C64x DSP Two Level Internal Memory Reference Guide</i> (literature number SPRU610) for details of this operation. If a previous cache operation is still active, the function waits for its completion before initiating the new operation, in order to prevent lockout of interrupts.</p> <p>If the user specifies CACHE_NOWAIT, then the function returns immediately, regardless of whether the operation has completed. The user can call CACHE_wait() afterwards to wait for the operation to complete.</p> <p>Although the block size can be specified in number of bytes, the cache controller operates on whole cache lines only. To prevent unintended behavior, blockPtr and byteCnt should be multiples of the cache line size.</p>
Example	<pre>char buffer[1024]; /* call with wait flag set */ CACHE_wbInvL2(buffer, 1024, CACHE_WAIT); ... /* call without the wait flag set */ CACHE_wbInvL2(buffer, 1024, CACHE_NOWAIT); CACHE_wait();</pre>

CACHE_wbL2

CACHE_wbL2

L2 block writeback

Function	<pre>void CACHE_wbL2(void *blockPtr, Uint32 byteCnt, int wait);</pre>
Arguments	<p>blockPtr Pointer to the beginning of the block</p> <p>byteCnt Number of bytes in the block. This value must be a multiple of four. The largest size this can be in 65535*4.</p> <p>wait Wait flag:</p> <ul style="list-style-type: none"><input type="checkbox"/> CACHE_NOWAIT – return immediately<input type="checkbox"/> CACHE_WAIT – wait until the operation completes
Return Value	none
Description	<p>This function issues an L2 block writeback command to the cache controller. Please see the <i>TMS320C621x/C671x DSP Two Level Internal Memory Reference Guide</i> (literature number SPRU609) and the <i>TMS320C64x DSP Two Level Internal Memory Reference Guide</i> (literature number SPRU610) for details of this operation for details of this operation. If a previous cache operation is still active, the function waits for its completion before initiating the new operation, in order to prevent lockout of interrupts.</p> <p>If the user specifies CACHE_NOWAIT, then the function returns immediately, regardless of whether the operation has completed. The user can call <code>CACHE_wait()</code> afterwards to wait for the operation to complete.</p> <p>Although the block size can be specified in number of bytes, the cache controller operates on whole cache lines only. To prevent unintended behavior, <code>blockPtr</code> and <code>byteCnt</code> should be multiples of the cache line size.</p>
Example	<pre>char buffer[1024]; /* call with wait flag set */ CACHE_wbL2(buffer, 1024, CACHE_WAIT); ... /* call without the wait flag set */ CACHE_wbL2(buffer, 1024, CACHE_NOWAIT); CACHE_wait();</pre>

CHIP Module

This chapter describes the CHIP module, lists the API functions and macros within the module, and provides a CHIP API reference section.

Topic	Page
3.1 Overview	3-2
3.2 Macros	3-3
3.3 Functions	3-4

3.1 Overview

The CHIP module is where chip-specific and chip-related code resides. This module has the potential to grow in the future as more devices are placed on the market. Currently, CHIP has some API functions for obtaining device endianness, memory map mode if applicable, and CPU and REV IDs. The CHIP_Config structure contains a single field which holds the unsigned device configuration value.

Table 3–1 shows the API functions within the CHIP module.

Table 3–1. CHIP APIs

Syntax	Type	Description	See page ...
CHIP_6XXX	C	Current device identification symbols	3-4
CHIP_getCpuld	F	Returns the CPU ID field of the CSR register	3-5
CHIP_getEndian	F	Returns the current endian mode of the device	3-5
CHIP_getMapMode	F	Returns the current map mode of the device	3-6
CHIP_getRevId	F	Returns the CPU revision ID	3-6
CHIP_SUPPORT	C	A compile time constant whose value is 1 if the device supports the CHIP module	3-6
CHIP_config [†]	F	Set device configuration	3-7
CHIP_getConfig [†]	F	Get device configuration	3-7
CHIP_configArgs [†]	F	Set device configuration	3-7

Note: F = Function; C = Constant

[†] Only for C6713, DA610, C6412, C6711C, C6712C, DM642, DM641, DM640, C6410, C6413 and C6418 devices.

3.2 Macros

There are two types of CHIP macros: those that access registers and fields, and those that construct register and field values.

Table 3–2 lists the CHIP macros that access registers and fields, and Table 3–3 lists the CHIP macros that construct register and field values. The macros themselves are found in Chapter 28, *Using the HAL Macros*.

CHIP macros are not handle-based.

Table 3–2. CHIP Macros that Access Registers and Fields

Macro	Description/Purpose	See page...
CHIP_CRGET(<REG>)	Gets the value of CPU register	28-12
CHIP_CRSET(<REG>,x)	Sets the value of CPU register	28-13
CHIP_RGET(<REG>)	Returns the value in the memory-mapped register	28-18
CHIP_RSET(<REG>,x)	Writes the value to the memory-mapped register	28-20
CHIP_FGET(<REG>,<FIELD>)	Returns the value of the specified field in the register	28-13
CHIP_FSET(<REG>,<FIELD>,fieldval)	Writes <i>fieldval</i> to the specified field of the register	28-15
CHIP_FSETS(<REG>,<FIELD>,<SYM>)	Writes the symbol value to the specified field in the peripheral	28-17

Table 3–3. CHIP Macros that Construct Register and Field Values

Macro	Description/Purpose	See page...
CHIP_<REG>_DEFAULT	Register default value	28-21
CHIP_<REG>_RMK()	Register make	28-23
CHIP_<REG>_OF()	Register value of ...	28-22
CHIP_<REG>_<FIELD>_DEFAULT	Field default value	28-24
CHIP_FMK()	Field make	28-14
CHIP_FMKS()	Field make symbolically	28-15
CHIP_<REG>_<FIELD>_OF()	Field value of ...	28-24
CHIP_<REG>_<FIELD>_<SYM>	Field symbolic value	28-24

3.3 Functions

CHIP_6XXX *Current chip identification symbols*

Constant	CHIP_6201 CHIP_6202 CHIP_6203 CHIP_6204 CHIP_6205 CHIP_6211 CHIP_6414 CHIP_6415 CHIP_6416 CHIP_6701 CHIP_6711 CHIP_6712 CHIP_6713 CHIP_DA610 CHIP_6410 CHIP_6413 CHIP_6418 CHIP_DM642 CHIP_DM641 CHIP_DM640
Description	<p>These are the current chip identification symbols. They are used throughout the CSL code to make compile-time decisions. When using the CSL, you have to select the right chip type under Global Setting module. The chip type will generate the associated macro CHIP_6XXX.</p> <p>You may also use these symbols to perform conditional compilation; for example:</p> <pre>#if (CHIP_6201) /* user CHIP configuration for 6201 / #elif (CHIP_6211) / user CHIP configuration for 6211 */ #endif</pre>

CHIP_getCpuId *Returns CPU ID field of CSR register*

Function	Uint32 CHIP_getCpuId();
Arguments	none
Return Value	CPU ID Returns the CPU ID
Description	This function returns the CPU ID field of the CSR register.
Example	<pre>Uint32 CpuId; CpuId = CHIP_getCpuId();</pre>

CHIP_getEndian *Returns current endian mode of device*

Function	int CHIP_getEndian();
Arguments	none
Return Value	endian mode Returns the current endian mode of the device; will be one of the following: <input type="checkbox"/> CHIP_ENDIAN_BIG <input type="checkbox"/> CHIP_ENDIAN_LITTLE
Description	Returns the current endian mode of the device as determined by the EN bit of the CSR register.
Example	<pre>Uint32 Endian; 0 Endian = CHIP_getEndian(); if (Endian == CHIP_ENDIAN_BIG) { /* user big endian configuration / } else { / user little endian configuration */ }</pre>

CHIP_getMapMode

CHIP_getMapMode *Returns current map mode of device*

Function	int CHIP_getMapMode();
Arguments	none
Return Value	map mode Returns current device MAP mode; will be one of the following: <input type="checkbox"/> CHIP_MAP_0 <input type="checkbox"/> CHIP_MAP_1
Description	Returns the current MAP mode of the device as determined by the MAP bit of the EMIF global control register.
Example	<pre>Uint32 MapMode; 0 MapMode = CHIP_getMapMode(); if (MapMode == CHIP_MAP_0) { /* user map 0 configuration / } else { / user map 1 configuration */ }</pre>

CHIP_getRevId *Returns CPU revision ID*

Function	Uint32 CHIP_getRevId();
Arguments	none
Return Value	revision ID Returns CPU revision ID
Description	This function returns the CPU revision ID as determined by the <i>Revision ID</i> field of the CSR register.
Example	<pre>Uint32 RevId; RevId = CHIP_getRevId();</pre>

CHIP_SUPPORT *Compile-time constant*

Constant	CHIP_SUPPORT
Description	Compile-time constant that has a value of 1 if the device supports the CHIP module and 0 otherwise. You are not required to use this constant. Currently, all devices support this module.
Example	<pre>#if (CHIP_SUPPORT) /* user CHIP configuration */ #endif</pre>

CHIP_config*Set device configuration*

Function	<pre>void CHIP_config(CHIP_Config *config);</pre>
Arguments	Address of config structure
Return Value	None
Description	Writes the device configuration value held in the config structure to config address

CHIP_getConfig*Gets the device configuration*

Function	<pre>void CHIP_getConfig(CHIP_Config *config);</pre>
Arguments	Address of config structure
Return Value	None
Description	Gets the device configuration value stored in the config structure to configuration address. This value is written to the devcfg field of the structure.

CHIP_configArgs*Sets the device configuration*

Function	<pre>void CHIP_configArgs(unit32 devcfg);</pre>
Arguments	devcfg
Return Value	None
Description	Writes the devcfg value to the device configuration address.

CSL Module

This chapter describes the CSL module, shows the single API function within the module, and provides a CSL API reference section.

Topic	Page
4.1 Overview	4-2
4.2 Functions	4-3

4.1 Overview

The CSL module is the top-level API module whose primary purpose is to initialize the library.

The *CSL_init()* function must be called once at the beginning of your program before calling any other CSL API functions.

Table 4–1 shows the only function exported by the CSL module.

Table 4–1. CSL API

Syntax	Type	Description	See page ...
CSL_init	F	Initializes the CSL library	4-3

Note: F = Function

4.2 Functions

CSL_init *Calls initialization function of all CSL API modules*

Function void CSL_init();

Arguments none

Return Value none

Description The CSL module is the top-level API module whose primary purpose is to initialize the library. Only one function is exported:

CSL_init()

The *CSL_init()* function must be called once at the beginning of your program before calling any other CSL API functions.

Example `CSL_init();`

DAT Module

This chapter describes the DAT module, lists the API functions within the DAT module, discusses how the DAT module manages the DMA/EDMA peripheral, and provides a DAT API reference section.

Topic	Page
5.1 Overview	5-2
5.2 Functions	5-4

5.1 Overview

The data module (DAT) is used to move data around by means of DMA/EDMA hardware. This module serves as a level of abstraction such that it works the same for devices that have the DMA peripheral as for devices that have the EDMA peripheral. Therefore, application code that uses the DAT module is compatible across all current devices regardless of which type of DMA controller it has.

Table 5–1 shows the API functions within the DAT module.

Table 5–1. DAT APIs

Syntax	Type	Description	See page ...
DAT_busy	F	Checks to see if a previous transfer has completed	5-4
DAT_close	F	Closes the DAT module	5-4
DAT_copy	F	Copies a linear block of data from Src to Dst using DMA or EDMA hardware	5-5
DAT_copy2d	F	Performs a 2-dimensional data copy using DMA or EDMA hardware.	5-6
DAT_fill	F	Fills a linear block of memory with the specified fill value using DMA or EDMA hardware	5-8
DAT_open	F	Opens the DAT module	5-10
DAT_setPriority	F	Sets the priority CPU vs DMA/EDMA	5-11
DAT_SUPPORT	C	A compile time constant whose value is 1 if the device supports the DAT module	5-12
DAT_wait	F	Waits for a previous transfer to complete	5-13

Note: F = Function; C = Constant

5.1.1 DAT Routines

The DAT module has been intentionally kept simple. There are routines to copy data from one location to another and routines to fill a region of memory.

These operations occur in the background on dedicated DMA hardware independent of the CPU. Because of this asynchronous nature, there is API support that enables waiting until a given copy/fill operation completes. It works like this: call one of the copy/fill functions and get an ID number as a return value. Then use this ID number later on to wait for the operation to complete. This allows the operation to be submitted and performed in the background while the CPU performs other tasks in the foreground. Then as needed, the CPU can block on completion of the operation before moving on.

5.1.2 DAT Macros

There are no register and field access macros dedicated to the DAT module. The only macros used by DAT are equivalent to the DMA or EDMA macros.

5.1.3 DMA/EDMA Management

Since the DAT module uses the DMA/EDMA peripheral, it must do so in a managed way. In other words, it must not use a DMA channel that is already allocated by the application. To ensure that this does not happen, the DAT module must be opened before use, this is accomplished using the `DAT_open()` API function. Opening the DAT module allocates a DMA channel for exclusive use. If the module is no longer needed, the DMA resource may be freed up by closing the DAT module with `DAT_close()`.

Note:

For devices that have EDMA, the DAT module uses the quick DMA feature. This means that the module does not have to internally allocate a DMA channel. However, you are still required to open the DAT module before use.

5.1.4 Devices With DMA

On devices that have the DMA peripheral, such as the 6201, only one request may be active at once since only one DMA channel is used. If you submit two requests one after the other, the first one will be programmed into the DMA hardware immediately but the second one will have to wait until the first completes. The APIs will block (spin) if called while a request is still busy by polling the transfer complete interrupt flag. The completion interrupt is not actually enabled to eliminate the overhead of taking an interrupt, but the interrupt flag is still active.

5.1.5 Devices With EDMA

On devices with EDMA, it is possible to have multiple requests pending because of hardware request queues. Each call into the `DAT_copy()` or `DAT_fill()` function returns a unique transfer ID number. This ID number is then used by the user so that the transfer can be completed. The ID number allows the library to distinguish between multiple pending transfers. As with the DMA, transfer completion is determined by monitoring EDMA transfer complete codes (interrupt flags).

DAT_busy

5.2 Functions

DAT_busy *Checks to see if a previous transfer has completed*

Function	Uint32 DAT_busy(Uint32 id);
Arguments	id Transfer identifier, returned by one of the DAT copy or DAT fill routines.
Return Value	busy Returns non-zero if transfer is still busy, zero otherwise.
Description	Checks to see if a previous transfer has completed or not, identified by the transfer ID.
Example	<pre>DAT_open(DAT_CHAANY, DAT_PRI_LOW, 0); ... transferId = DAT_copy(src, dst, len); ... while (DAT_busy(transferId));</pre>

DAT_close *Closes DAT module*

Function	void DAT_close();
Arguments	none
Return Value	none
Description	Closes the DAT module. First, any pending requests are allowed to complete; then if applicable, any DMA channels used by the DAT module are closed.
Example	<pre>DAT_close();</pre>

DAT_copy*Copies linear block of data from Src to Dst using DMA or EDMA hardware*

Function	<pre> Uint32 DAT_copy(void *src, void *dst, Uint16 byteCnt); </pre>
Arguments	<pre> src Pointer to source data dst Pointer to destination location byteCnt Number of bytes to copy </pre>
Return Value	<pre> xfrId Transfer ID </pre>
Description	<p>Copies a linear block of data from <code>Src</code> to <code>Dst</code> using DMA or EDMA hardware, depending on the device. The arguments are checked for alignment and the DMA is submitted accordingly. For best performance in devices other than C64x devices, you should ensure that the source and destination addresses are aligned on a 4-byte boundary and the transfer length is a multiple of four. A maximum of 65,535 bytes may be copied. A <code>byteCnt</code> of zero has unpredictable results.</p> <p>For C64x devices, the EDMA uses a 64-bit bus (8 bytes) to L2 SRAM. For best efficiency, the source and destination addresses should be aligned on an 8-byte boundary, with the transfer rate a multiple of eight.</p> <p>If the DMA channel is busy with one or more previous requests, the function will block and wait for completion before submitting this request.</p> <p>The DAT module must be opened before calling this function. See <code>DAT_open()</code>.</p> <p>The return value is a transfer identifier that may be used later on to wait for completion. See <code>DAT_wait()</code>.</p>
Example	<pre> #define DATA_SIZE 256 Uint32 BuffA[DATA_SIZE/sizeof(Uint32)]; Uint32 BuffB[DATA_SIZE/sizeof(Uint32)]; ... DAT_open(DAT_CHAANY, DAT_PRI_LOW, 0); DAT_copy(BuffA, BuffB, DATA_SIZE); ... </pre>

DAT_copy2d

DAT_copy2d

Performs 2-dimensional data copy

Function	Uin32 DAT_copy2d(Uin32 type, void *src, void *dst, Uin16 lineLen, Uin16 lineCnt, Uin16 linePitch);												
Arguments	<table><tr><td>type</td><td>Transfer type: <input type="checkbox"/> DAT_1D2D <input type="checkbox"/> DAT_2D1D <input type="checkbox"/> DAT_2D2D</td></tr><tr><td>src</td><td>Pointer to source data</td></tr><tr><td>dst</td><td>Pointer to destination location</td></tr><tr><td>lineLen</td><td>Number of bytes per line</td></tr><tr><td>lineCnt</td><td>Number of lines</td></tr><tr><td>linePitch</td><td>Number of bytes between start of one line to start of next line</td></tr></table>	type	Transfer type: <input type="checkbox"/> DAT_1D2D <input type="checkbox"/> DAT_2D1D <input type="checkbox"/> DAT_2D2D	src	Pointer to source data	dst	Pointer to destination location	lineLen	Number of bytes per line	lineCnt	Number of lines	linePitch	Number of bytes between start of one line to start of next line
type	Transfer type: <input type="checkbox"/> DAT_1D2D <input type="checkbox"/> DAT_2D1D <input type="checkbox"/> DAT_2D2D												
src	Pointer to source data												
dst	Pointer to destination location												
lineLen	Number of bytes per line												
lineCnt	Number of lines												
linePitch	Number of bytes between start of one line to start of next line												
Return Value	xfrId Transfer ID												
Description	<p>Performs a 2-dimensional data copy using DMA or EDMA hardware, depending on the device. The arguments are checked for alignment and the hardware configured accordingly. For best performance on devices other than C64x devices, you should ensure that the source address and destination address are aligned on a 4-byte boundary and that the <code>lineLen</code> and <code>linePitch</code> are multiples of 4-bytes.</p> <p>For C64x devices, the EDMA uses a 64-bit bus (8 bytes) to L2 SRAM. For best efficiency, the source and destination addresses should be aligned on an 8-byte boundary with the transfer rate a multiple of eight.</p> <p>If the channel is busy with previous requests, this function will block (spin) and wait until it frees up before submitting this request.</p> <p>Note: The DAT module must be opened with the <code>DAT_OPEN_2D</code> flag before calling this function. See <code>DAT_open()</code>.</p> <p>There are three ways to submit a 2D transfer: 1D to 2D, 2D to 1D, and 2D to 2D. This is specified using the <code>type</code> argument. In all cases, the number of bytes copied is <code>lineLen × lineCnt</code>. The 1D part of the transfer is just a linear block of data. The 2D part is illustrated in Figure 5-1.</p>												

Figure 5–1. 2D Transfer

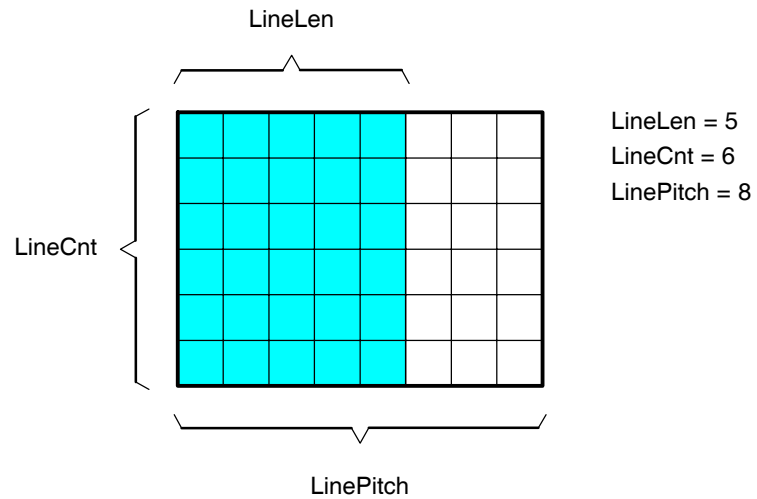

If a 2D to 2D transfer is specified, both the source and destination have the same `lineLen`, `lineCnt`, and `linePitch`.

The return value is a transfer identifier that may be used later on to wait for completion. See `DAT_wait()`.

Example

```
DAT_copy2d (DAT_1D2D, buffA, buffB, 16, 8, 32);
```

DAT_fill

DAT_fill

Fills linear block of memory with specified fill value using DMA hardware

Function	Uin32 DAT_fill(void *dst, Uin16 byteCnt, Uin32 *fillValue);
Arguments	dst Pointer to destination location byteCnt Number of bytes to fill fillValue Pointer to fill value
Return Value	xfrId Transfer ID
Description	<p>Fills a linear block of memory with the specified fill value using DMA hardware. The arguments are checked for alignment and the DMA is submitted accordingly. For best performance, you should ensure that the destination address is aligned on a 4-byte boundary and the transfer length is a multiple of 4. A maximum of 65,535 bytes may be filled.</p> <p>For devices other than C64x devices, the fill value is 8-bits in size but must be contained in a 32-bit word. This is due to the way the DMA hardware works. If the arguments are 32-bit aligned, then the DMA transfer element size is set to 32-bits to maximize performance. This means that the source of the transfer, the fill value, must be 32-bits in size. So, the 8-bit fill value must be repeated to fill the 32-bit value. For example, if you want to fill a region of memory with the value 0xA5, the fill value should contain 0xA5A5A5A5 before calling this function. If the arguments are 16-bit aligned, a 16-bit element size is used. Finally, if any of the arguments are 8-bit aligned, an 8-bit element size is used. It is a good idea to always fill in the entire 32-bit fill value to eliminate any endian issues.</p> <p>For C64x devices, the fill count must be a multiple of 8 bytes. The EDMA uses a 64-bit bus to store data in L2 SRAM. A pointer of 64-bit value must be passed to the "fillvalue" parameter (a set of 8 consecutive bytes, aligned). The EDMA transfer element size is set to 64-bits. If you want to fill the memory region with a value of 0x1234, the pointer should point to two consecutive 32-bit words set to 0x12341234 value .</p> <p>If the DMA channel is busy with a previous request, the function will block and wait for completion before submitting this request.</p> <p>The DAT module must be opened before calling this function. See DAT_open () .</p>

The return value is a transfer identifier that may be used later on to wait for completion. See DAT_wait().

Note:

You should be aware that if the fill value is in cache, the DMA always uses the external address and not the value that is in cache. It is up to you to ensure that the fill value is flushed before calling this function. Also, since the user specifies a pointer to the fill value, it is important not to write to it while the fill is in progress.

Example

```
Uint32  BUFF_SIZE 256;
Uint32  buff[BUFF_SIZE/sizeof(Uint32)];
Uint32  fillValue = 0xA5A5A5A5;
...
DAT_open(DAT_CHAANY, DAT_PRI_LOW, 0);
DAT_fill(buff, BUFF_SIZE, &fillValue);
```

For 64x devices:

```
Uint32  BUFF_SIZE 256; /* 8 * 8bytes */
Uint32  buff[BUFF_SIZE/sizeof(Uint32)];
Uint32  fillValue[2] = {0x12341234, 0x12341234};
Uint32  *fillValuePtr = fillValue;
...
DAT_open(DAT_CHAANY, DAT_PRI_LOW, 0);
DAT_fill(buff, BUFF_SIZE, &fillValue);
```

DAT_open

DAT_open

Opens DAT module

Function	Uint32 DAT_open(int chaNum, int priority, Uint32 flags);	
Arguments	chaNum	Specifies which DMA channel to allocate; must be one of the following: <input type="checkbox"/> DAT_CHAANY <input type="checkbox"/> DAT_CHA0 <input type="checkbox"/> DAT_CHA1 <input type="checkbox"/> DAT_CHA2 <input type="checkbox"/> DAT_CHA3
	priority	Specifies the priority of the DMA channel; must be one of the following: <input type="checkbox"/> DAT_PRI_LOW <input type="checkbox"/> DAT_PRI_HIGH
	flags	Miscellaneous open flags <input type="checkbox"/> DAT_OPEN_2D
Return Value	success for failure are:	Returns zero on failure and non-zero if successful. Reasons for failure are: <input type="checkbox"/> The DAT module is already open. <input type="checkbox"/> Required resources could not be allocated.
Description	<p>This function opens up the DAT module and must be called before calling any of the other DAT API functions. The <code>ChaNum</code> argument specifies which DMA channel to open for exclusive use by the DAT module. For devices with EDMA, the <code>ChaNum</code> argument is ignored because the quick DMA is used which does not have a channel associated with it.</p> <p>For DMA Devices:</p> <ul style="list-style-type: none"><input type="checkbox"/> <code>ChaNum</code> specifies which DMA channel to use<input type="checkbox"/> <code>DAT_PRI_LOW</code> sets the DMA channel up for CPU priority<input type="checkbox"/> <code>DAT_PRI_HIGH</code> sets the DMA channel up for DMA priority <p>For EDMA Devices:</p> <ul style="list-style-type: none"><input type="checkbox"/> <code>ChaNum</code> is ignored	

- DAT_PRI_LOW sets LOW priority
- DAT_PRI_HIGH sets HIGH priority

Once the DAT module is opened, any resources allocated, such as DMA channels, remain allocated. You can call `DAT_close()` to free these resources.

If 2D transfers are planned via `DAT_copy2d`, the `DAT_OPEN_2D` flag must be specified. Specifying this flag for devices with the DMA peripheral will cause allocation of one global count reload register and one global index register. These global registers are freed when `DAT_close()` is called.

Note:

For devices with EDMA, the DAT module uses the EDMA registers to submit transfer requests. Also used is the channel interrupt pending register (CIPR). Interrupts are not enabled but the completion flags in CIPR are used. The DAT module uses interrupt completion codes 1 through 4 which amounts to a mask of 0x0000001E in the CIPR register. If you use the DAT module on devices with EDMA, you must avoid using transfer completion codes 1 through 4.

Example

To open the DAT module using any available DMA channel, use:

```
DAT_open (DAT_CHAANY, DAT_PRI_LOW, 0);
```

To open the DAT module using DMA channel 2 in high-priority mode, use:

```
DAT_open (DAT_CHA2, DAT_PRI_HIGH, 0);
```

To open the DAT module for 2D copies, use:

```
DAT_open (DAT_CHAANY, DAT_PRI_HIGH, DAT_OPEN_2D);
```

DAT_setPriority

Sets the priority of DMA or EDMA channel

Function

```
void DAT_setPriority(
int priority
);
```

Arguments

priority Priority bit value

Return Value

none

Description

Sets the priority bit value PRI of PRICTL register for devices supporting DMA, and the PRI of OPT register for devices supporting EDMA. See also `DAT_open()` function. The priority value can be set by using the following predefined constants:

DAT_SUPPORT

DAT_PRI_LOW

DAT_PRI_HIGH

Example

```
/* Open DAT channel with priority Low */
DAT_open(DMA_CHAANY, DAT_PRI_LOW, 0)
/* Set transfer with priority high */
DAT_setPriority(DAT_PRI_HI);
```

DAT_SUPPORT

Compile-time constant

Constant

DAT_SUPPORT

Description

Compile-time constant that has a value of 1 if the device supports the DAT module and 0 otherwise. You are not required to use this constant.

Note: The DAT module is supported by all devices that have an EDMA or DMA peripheral.

Example

```
#if (DAT_SUPPORT)
    /* user DAT configuration */
#endif
```

DAT_wait*Waits for previous transfer to complete identification by transfer ID*

Function	void DAT_wait(Uint32 id);
Arguments	id Transfer identifier, returned by one of the DAT copy or DAT fill routines. Two predefined transfer IDs may be used: <input type="checkbox"/> DAT_XFRID_WAITALL <input type="checkbox"/> DAT_XFRID_WAITNONE Using DAT_XFRID_WAITALL means wait until all transfers have completed. Using DAT_XFRID_WAITNONE means do not wait for any transfers to complete. This can be useful as the first operation in a pipelined copy sequence.
Return Value	none
Description	This function waits for a previous transfer to complete, identified by the transfer ID. If the transfer has already completed, this function returns immediately. Interrupts are not disabled during the wait.
Example	<pre>Uint32 transferId; ... DAT_open(DAT_CHAANY, DAT_PRI_LOW, 0); ... transferId = DAT_copy(src, dst, len); /* user DAT configuration */ DAT_wait(transferId);</pre>

DMA Module

This chapter describes the DMA module, lists the API functions and macros within the module, discusses how to use a DMA channel, and provides a DMA API reference section.

Topic	Page
6.1 Overview	6-2
6.2 Macros	6-5
6.3 Configuration Structures	6-7
6.4 Functions	6-9

6.1 Overview

Currently, there are two DMA architectures used on TMS320C6x™ devices: DMA and EDMA (enhanced DMA). Devices such as the C6201™ have the DMA peripheral, whereas the C6211™ has the EDMA peripheral. The two architectures are different enough to warrant a separate API module for each.

Table 6–1 lists the configuration structures for use with the DMA functions. Table 6–2 lists the functions and constants available in the CSL DMA module.

Table 6–1. DMA Configuration Structures

Structure	Purpose	See page ...
DMA_Config	DMA structure that contains all local registers required to set up a specific DMA channel	6-7
DMA_GlobalConfig	Global DMA structure that contains all global registers that you may need to initialize a DMA channel	6-8

Table 6–2. DMA APIs

(a) DMA Primary Functions

Syntax	Type	Description	See page ...
DMA_close	F	Closes a DMA channel opened via <code>DMA_open()</code>	6-9
DMA_config	F	Sets up the DMA channel using the configuration structure	6-9
DMA_configArgs	F	Sets up the DMA channel using the register values passed in	6-10
DMA_open	F	Opens a DMA channel for use	6-11
DMA_pause	F	Pauses the DMA channel by setting the START bits in the primary control register appropriately	6-12
DMA_reset	F	Resets the DMA channel by setting its registers to power-on defaults	6-12
DMA_start	F	Starts a DMA channel running without auto-initialization	6-13
DMA_stop	F	Stops a DMA channel by setting the START bits in the primary control register appropriately	6-13

Note: F = Function; C = Constant; M = Macro

Table 6–2. DMA APIs (Continued)

<i>(b) DMA Global Register Functions</i>			
Syntax	Type	Description	See page ...
DMA_allocGlobalReg	F	Provides resource management for the DMA global registers	6-14
DMA_freeGlobalReg	F	Frees a global DMA register previously allocated by calling <code>DMA_AllocGlobalReg()</code>	6-16
DMA_getGlobalReg	F	Reads a global DMA register that was previously allocated by calling <code>DMA_AllocGlobalReg()</code>	6-16
DMA_getGlobalRegAddr	F	Gets DMA global register address	6-17
DMA_globalAlloc	F	Allocates DMA global registers	6-18
DMA_globalConfig	F	Configures entry for DMA configuration structure	6-19
DMA_globalConfigArgs	F	Configures entry for DMA registers	6-20
DMA_globalFree	F	Frees Allocated DMA global register	6-22
DMA_globalGetConfig	F	Returns the entry for the DMA configuration structure	6-22
DMA_setGlobalReg	F	Sets value of a global DMA register previously allocated by calling <code>DMA_AllocGlobalReg()</code>	6-23
<i>(c) DMA Auxiliary Functions, Constants, and Macros</i>			
Syntax	Type	Description	See page ...
DMA_autoStart	F	Starts a DMA channel with auto-initialization	6-23
DMA_CHA_CNT	C	Number of DMA channels for the current device	6-24
DMA_CLEAR_CONDITION	M	Clears condition flag	6-24
DMA_GBLADDRA	C	DMA global address register A mask	6-24
DMA_GBLADDRB	C	DMA global address register B mask	6-24
DMA_GBLADDRC	C	DMA global address register C mask	6-25
DMA_GBLADDRD	C	DMA global address register D mask	6-25
DMA_GBLCNTA	C	DMA global count reload register A mask	6-25
DMA_GBLCNTB	C	DMA global count reload register B mask	6-25
DMA_GBLIDXA	C	DMA global index register A mask	6-25

Note: F = Function; C = Constant; M = Macro

Table 6–2. DMA APIs (Continued)

DMA_GBLIDXB	C	DMA global index register B mask	6-26
DMA_GET_CONDITION	M	Gets condition flag	6-26
DMA_getConfig	F	Reads the current DMA configuration structure	6-26
DMA_getEventId	F	Returns the IRQ event ID for the DMA completion interrupt	6-27
DMA_getStatus	F	Reads the status bits of the DMA channel	6-27
DMA_restoreStatus	F	Restores the status from DMA_getStatus() by setting the START bit of the PRICTL primary control register	6-27
DMA_setAuxCtl	F	Sets the DMA AUXCTL register	6-28
DMA_SUPPORT	C	A compile time constant whose value is 1 if the device supports the DMA module	6-28
DMA_wait	F	Enters a spin loop that polls the DMA status bits until the DMA completes	6-29

Note: F = Function; C = Constant; M = Macro

6.1.1 Using a DMA Channel

To use a DMA channel, you must first open it and obtain a device handle using `DMA_open()`. Once opened, you use the device handle to call the other API functions. The channel may be configured by passing a `DMA_Config` structure to `DMA_config()` or by passing register values to the `DMA_configArgs()` function. To assist in creating register values, there are *DMA_RMK* (make) macros that construct register values based on field values. In addition, there are symbol constants that may be used for the field values.

There are functions for managing shared global DMA registers, `DMA_allocGlobalReg()`, `DMA_freeGlobalReg()`, `DMA_setGlobalReg()`, and `DMA_getGlobalReg()`.

6.2 Macros

There are two types of DMA macros: those that access registers and fields, and those that construct register and field values.

Table 6–3 lists the DMA macros that access registers and fields, and Table 6–4 lists the DMA macros that construct register and field values. The macros themselves are found in Chapter 28, *Using the HAL Macros*.

The DMA module includes handle-based macros.

Table 6–3. DMA Macros that Access Registers and Fields

Macro	Description/Purpose	See page ...
DMA_ADDR(<REG>)	Register address	28-12
DMA_RGET(<REG>)	Returns the value in the peripheral register	28-18
DMA_RSET(<REG>,x)	Register set	28-20
DMA_FGET(<REG>,<FIELD>)	Returns the value of the specified field in the peripheral register	28-13
DMA_FSET(<REG>,<FIELD>,fieldval)	Writes <i>fieldval</i> to the specified field in the peripheral register	28-15
DMA_FSETS(<REG>,<FIELD>,<SYM>)	Writes the symbol value to the specified field in the peripheral	28-17
DMA_RGETA(addr,<REG>)	Gets register for a given address	28-19
DMA_RSETA(addr,<REG>,x)	Sets register for a given address	28-20
DMA_FGETA(addr,<REG>,<FIELD>)	Gets field for a given address	28-13
DMA_FSETA(addr,<REG>,<FIELD>,fieldval)	Sets field for a given address	28-16
DMA_FSETSA(addr,<REG>,<FIELD>,<SYM>)	Sets field symbolically for a given address	28-17
DMA_ADDRH(h,<REG>)	Returns the address of a memory-mapped register for a given handle	28-12
DMA_RGETH(h,<REG>)	Returns the value of a register for a given handle	28-19
DMA_RSETH(h,<REG>,x)	Sets the register value to x for a given handle	28-21
DMA_FGETH(h,<REG>,<FIELD>)	Returns the value of the field for a given handle	28-14
DMA_FSETH(h,<REG>,<FIELD>,fieldval)	Sets the field value to x for a given handle	28-16

Table 6–4. DMA Macros that Construct Register and Field Values

Macro	Description/Purpose	See page ...
DMA_<REG>_DEFAULT	Register default value	28-21
DMA_<REG>_RMK()	Register make	28-23
DMA_<REG>_OF()	Register value of ...	28-22
DMA_<REG>_<FIELD>_DEFAULT	Field default value	28-24
DMA_FMK()	Field make	28-14
DMA_FMKS()	Field make symbolically	28-15
DMA_<REG>_<FIELD>_OF()	Field value of ...	28-24
DMA_<REG>_<FIELD>_<SYM>	Field symbolic value	28-24

6.3 Configuration Structures

Because the DMA has both local and global registers for each channel, the CSL DMA module has two configuration structures:

- ❑ **DMA_Config** (channel configuration structure) contains all the local registers required to set up a specific DMA channel.
- ❑ **DMA_GlobalConfig** (global configuration structure) contains all the global registers needed to initialize a DMA channel. These global registers are resources shared across the different DMA channels, and include element/frame indexes and reload registers, as well as src/dst page registers.

You can use literal values or the `_RMK` macros to create the structure member values.

DMA_Config

DMA configuration structure used to set up DMA channel

Structure	DMA_Config
Members	Uint32 prictl DMA primary control register value Uint32 secctl DMA secondary control register value Uint32 src DMA source address register value Uint32 dst DMA destination address register value Uint32 xfrcnt DMA transfer count register value
Description	This DMA configuration structure is used to set up a DMA channel. You create and initialize this structure and then pass its address to the <code>DMA_config()</code> function. You can use literal values or the <code>_RMK</code> macros to create the structure member values.
Example	<pre> DMA_Config MyConfig = { 0x00000050, /* prictl */ 0x00000080, /* secctl */ 0x80000000, /* src */ 0x80010000, /* dst */ 0x00200040 /* xfrcnt */ }; ... DMA_config(hDma, &MyConfig); </pre>

DMA_GlobalConfig

DMA_GlobalConfig *DMA global register configuration structure*

Structure

```
typedef struct {
    Uint32 addrA;
    Uint32 addrB;
    Uint32 addrC;
    Uint32 addrD;
    Uint32 idxA;
    Uint32 idxB;
    Uint32 cntA;
    Uint32 cntB;
} DMA_GlobalConfig;
```

Members

addrA	Global address register A value.
addrB	Global address register B value.
addrC	Global address register C value.
addrD	Global address register D value.
idxA	Global index register A value.
idxB	Global index register B value.
cntA	Global count reload register A value.
cntB	Global count reload register B value.

Description

This is the DMA global register configuration structure used to set up a DMA global register configuration. You create and initialize this structure, then pass its address to the DMA_globalConfig() function.

Example

```
Uint32 dmaGblRegMsk;
Uint32 dmaGblRegId = DMA_GBLADDRB | DMA_GBLADDRD;
DMA_GlobalConfig dmaGblCfg = {
    0x00000000, /* Global Address Register A */
    0x80001000, /* Global Address Register B */
    0x80002000, /* Global Address Register C */
    0x00000000, /* Global Address Register D */
    0x00000000, /* Global Index Register A */
    0x00000000, /* Global Index Register B */
    0x00000000, /* Global Count Reload Register A */
    0x00000000 /* Global Count Reload Register B */
};
dmaGblRegMsk = DMA_globalAlloc(dmaGblRegId);
DMA_globalConfig(dmaGblRegMsk, &dmaGblCfg);
```

6.4 Functions

6.4.1 Primary Functions

DMA_close *Closes DMA channel opened via DMA_open()*

Function	void DMA_close(DMA_Handle hDma);
Arguments	hDma Handle to DMA channel, see DMA_open ()
Return Value	none
Description	This function closes a DMA channel previously opened via DMA_open (). The registers for the DMA channel are set to their power-on defaults and the completion interrupt is disabled and cleared.
Example	DMA_close(hDma);

DMA_config *Sets up DMA channel using configuration structure*

Function	void DMA_config(DMA_Handle hDma, DMA_Config *Config);
Arguments	hDma Handle to DMA channel. See DMA_open () Config Pointer to an initialized configuration structure
Return Value	none
Description	Sets up the DMA channel using the configuration structure. The values of the structure are written to the DMA registers. The primary control register (<i>prictl</i>) is written last. See also DMA_configArgs () and DMA_Config.
Example	<pre> DMA_Config MyConfig = { 0x00000050, /* prictl */ 0x00000080, /* secctl */ 0x80000000, /* src */ 0x80010000, /* dst */ 0x00200040 /* xfrctl */ }; ... DMA_config(hDma, &MyConfig); </pre>

DMA_configArgs

DMA_configArgs Sets up DMA channel using register values passed in

Function	<pre>void DMA_configArgs(DMA_Handle hDma, Uint32 prctl, Uint32 secctl, Uint32 src, Uint32 dst, Uint32 xfrcnt);</pre>
Arguments	<p>hDma Handle to DMA channel. See <code>DMA_open()</code></p> <p>prctl Primary control register value</p> <p>secctl Secondary control register value</p> <p>src Source address register value</p> <p>dst Destination address register value</p> <p>xfrcnt Transfer count register value</p>
Return Value	none
Description	<p>Sets up the DMA channel using the register values passed in. The register values are written to the DMA registers. The primary control register (<i>prctl</i>) is written last. See also <code>DMA_config()</code>.</p> <p>You may use literal values for the arguments or for readability. You may use the <code>_RMK</code> macros to create the register values based on field values.</p>
Example	<pre>DMA_configArgs(hDma, 0x00000050, /* prctl */ 0x00000080, /* secctl */ 0x80000000, /* src */ 0x80010000, /* dst */ 0x00200040 /* xfrcnt */);</pre>

DMA_open*Opens DMA channel for use*

Function	DMA_Handle DMA_open(int chaNum, Uint32 flags);	
Arguments	chaNum	DMA channel to open: <input type="checkbox"/> DMA_CHAANY <input type="checkbox"/> DMA_CHA0 <input type="checkbox"/> DMA_CHA1 <input type="checkbox"/> DMA_CHA2 <input type="checkbox"/> DMA_CHA3
	flags	Open flags (logical OR of DMA_OPEN_RESET)
Return Value	Device Handle	Handle to newly opened device
Description	<p>Before a DMA channel can be used, it must first be opened by this function. Once opened, it cannot be opened again until closed. See <code>DMA_close()</code>. You have the option of either specifying exactly which physical channel to open or you can let the library pick an unused one for you by specifying <code>DMA_CHAANY</code>. The return value is a unique device handle that you use in subsequent DMA API calls. If the open fails, <code>INV</code> is returned.</p> <p>If the <code>DMA_OPEN_RESET</code> is specified, the DMA channel registers are set to their power-on defaults and the channel interrupt is disabled and cleared.</p>	
Example	<pre>DMA_Handle hDma; ... hDma = DMA_open(DMA_CHAANY, DMA_OPEN_RESET);</pre>	

DMA_pause

DMA_pause *Pauses DMA channel by setting START bits in primary control register*

Function void DMA_pause(
DMA_Handle hDma
);

Arguments hDma Handle to DMA channel. See DMA_open().

Return Value none

Description This function pauses the DMA channel by setting the START bits in the primary control register accordingly. See also DMA_start(), DMA_stop(), and DMA_autoStart().

Example DMA_pause(hDma);

DMA_reset *Resets DMA channel by setting its registers to power-on defaults*

Function void DMA_reset(
DMA_Handle hDma
);

Arguments hDma Handle to DMA channel. See DMA_open().

Return Value none

Description Resets the DMA channel by setting its registers to power-on defaults and disabling and clearing the channel interrupt. You may use INV as the device handle to reset all channels.

Example

```
/* reset an open DMA channel /  
DMA_reset(hDma);  
  
/ reset all DMA channels */  
DMA_reset(INV);
```

DMA_start *Starts DMA channel running without auto-initialization*

Function	<pre>void DMA_start(DMA_Handle hDma);</pre>
Arguments	hDma Handle to DMA channel, see <code>DMA_open()</code>
Return Value	none
Description	Starts a DMA channel running without auto-initialization by setting the START bits in the primary control register accordingly. See also <code>DMA_pause()</code> , <code>DMA_stop()</code> , and <code>DMA_autoStart()</code> .
Example	<pre>DMA_start(hDma);</pre>

DMA_stop *Stops DMA channel by setting START bits in primary control register*

Function	<pre>void DMA_stop(DMA_Handle hDma);</pre>
Arguments	hDma Handle to DMA channel. See <code>DMA_open()</code>
Return Value	none
Description	Stops a DMA channel by setting the START bits in the primary control register accordingly. See also <code>DMA_pause()</code> , <code>DMA_start()</code> , and <code>DMA_autoStart()</code> .
Example	<pre>DMA_stop(hDma);</pre>

6.4.2 DMA Global Register Functions

DMA_allocGlobalReg *Allocates global DMA register*

Function	UInt32 DMA_allocGlobalReg(DMA_Gbl regType, UInt32 initVal);				
Arguments	<table><tr><td>regType</td><td>Global register type; must be one of the following: <input type="checkbox"/> DMA_GBL_ADDRRLD <input type="checkbox"/> DMA_GBL_INDEX <input type="checkbox"/> DMA_GBL_CNTRLD <input type="checkbox"/> DMA_GBL_SPLIT</td></tr><tr><td>initVal</td><td>Value to initialize the register to</td></tr></table>	regType	Global register type; must be one of the following: <input type="checkbox"/> DMA_GBL_ADDRRLD <input type="checkbox"/> DMA_GBL_INDEX <input type="checkbox"/> DMA_GBL_CNTRLD <input type="checkbox"/> DMA_GBL_SPLIT	initVal	Value to initialize the register to
regType	Global register type; must be one of the following: <input type="checkbox"/> DMA_GBL_ADDRRLD <input type="checkbox"/> DMA_GBL_INDEX <input type="checkbox"/> DMA_GBL_CNTRLD <input type="checkbox"/> DMA_GBL_SPLIT				
initVal	Value to initialize the register to				
Return Value	Global Register ID Unique ID number for the global register				
Description	<p>Since the DMA global registers are shared, they must be controlled using resource management. This is done using <code>DMA_allocGlobalReg()</code> and <code>DMA_freeGlobalReg()</code> functions. Allocating a register ensures that it will not be reallocated until it is freed. The register ID may then be used to get or set the register value by calling <code>DMA_getGlobalReg()</code> and <code>DMA_setGlobalReg()</code> respectively. If the register cannot be allocated, a register ID of 0 is returned.</p> <p>The register ID may directly be used with the <code>DMA_PRICTL_RMK</code> macro.</p> <ul style="list-style-type: none"><input type="checkbox"/> DMA_GBL_ADDRRLD Allocate global address register for use as DMA DST RELOAD or DMA SRC RELOAD. Will allocate one of the following DMA registers:<ul style="list-style-type: none">■ Global Address Register B■ Global Address Register C■ Global Address Register D<input type="checkbox"/> DMA_GBL_INDEX Allocate global index register for use as DMA INDEX. Will allocate one of the following DMA registers:<ul style="list-style-type: none">■ Global Index Register A■ Global Index Register B				

DMA_GBL_CNTRLD

Allocate global count reload register for use as DMA CNT RELOAD. Will allocate one of the following DMA registers:

- Global Count Reload Register A
- Global Count Reload Register B

DMA_GBL_SPLIT

Allocate global address register for use as DMA SPLIT. Will allocated one of the following DMA registers:

- Global Address Register A
- Global Address Register B
- Global Address Register C

Example

```
Uint32 RegId;
...
/* allocate global index register and initialize it */
RegId = DMA_allocGlobalReg(DMA_GBL_
INDEX, 0x00200040);
```

DMA_freeGlobalReg

DMA_freeGlobalReg *Frees global DMA register that was previously allocated*

Function	<code>void DMA_freeGlobalReg(Uint32 regId);</code>
Arguments	<code>regId</code> Global register ID obtained from <code>DMA_allocGlobalReg()</code> .
Return Value	none
Description	This function frees a global DMA register that was previously allocated by calling <code>DMA_allocGlobalReg()</code> . Once freed, the register is available for reallocation.
Example	<pre>Uint32 RegId; ... /* allocate global index register and initialize it */ RegId = DMA_allocGlobalReg(DMA_GBL_INDEX, 0x00200040); ... /* some time later on when you're done with it */ DMA_freeGlobalReg(RegId);</pre>

DMA_getGlobalReg *Reads global DMA register that was previously allocated*

Function	<code>Uint32 DMA_getGlobalReg(Uint32 regId);</code>
Arguments	<code>regId</code> Global register ID obtained from <code>DMA_allocGlobalReg()</code> .
Return Value	Register Value Value read from register
Description	<p>This function returns the register value of the global DMA register that was previously allocated by calling <code>DMA_allocGlobalReg()</code>.</p> <p>If you prefer not to use the alloc/free paradigm for the global register management, the predefined register IDs may be used. You should be aware that use of predefined register IDs precludes the use of alloc/free. The list of predefined IDs are shown below:</p>

- DMA_GBL_ADDRRLDB
- DMA_GBL_ADDRRLDC
- DMA_GBL_ADDRRLDD
- DMA_GBL_INDEXA
- DMA_GBL_INDEXB
- DMA_GBL_CNTRLDA
- DMA_GBL_CNTRLDB
- DMA_GBL_SPLITA
- DMA_GBL_SPLITB
- DMA_GBL_SPLITC

Note:

DMA_GBL_ADDRRLDB denotes the same physical register as DMA_GBL_SPLITB and DMA_GBL_ADDRRLDC denotes the same physical register as DMA_GBL_SPLITC.

Example

```

Uint32 RegId;
Uint32 RegValue;
...
/* allocate global index register and initialize it /
RegId = DMA_allocGlobalReg(DMA_GBL_
INDEX, 0x00200040);
...
RegValue = DMA_getGlobalReg(RegId);

```

DMA_getGlobalRegAddr *Gets DMA global register address*

Function	Uint32 DMA_getGlobalRegAddr(Uint32 regId);
Arguments	regId DMA global registers ID
Return Value	Uint32 DMA global register address corresponding to regId
Description	Get DMA global register address and return the address value.
Example	<pre> Uint32 regId = DMA_GBL_ADDRRLDB; Uint32 regAddr; regAddr = DMA_getGlobalRegAddr(regId); </pre>

DMA_globalAlloc

DMA_globalAlloc *Allocates DMA global registers*

Function	Uint32 DMA_globalAlloc(Uint32 regs);
Arguments	regs DMA global registers ID
Return Value	Uint32 Allocated DMA global registers mask
Description	Allocates DMA global registers and returns a mask of allocated DMA global registers. Mask depends on DMA global register ID and the availability of the register.
Example	<pre>Uint32 dmaGblRegMsk; Uint32 regs = DMA_GBLADDRB DMA_GBLADDRC; DmaGblRegMsk = DMA_globalAlloc(regs);</pre>

DMA_globalConfig *Sets up the DMA global registers using the configuration structure*

Function	void DMA_globalConfig(Uint32 regs, DMA_GlobalConfig *cfg);
Arguments	regs DMA global register mask cfg Pointer to an initialized configuration structure.
Return Value	none
Description	Sets up the DMA global registers using the configuration structure. The values of the structure that are written to the DMA global registers depend on the DMA global register mask.

Example

```

Uint32 dmaGblRegMsk;
Uint32 dmaGblRegId = DMA_GBLADDRB | DMA_GBLADDRB;
DMA_GlobalConfig dmaGblCfg = {
    0x00000000, /* Global Address Register A */
    0x80001000, /* Global Address Register B */
    0x80002000, /* Global Address Register C */
    0x00000000, /* Global Address Register D */
    0x00000000, /* Global Index Register A */
    0x00000000, /* Global Index Register B */
    0x00000000, /* Global Count Reload Register A */
    0x00000000 /* Global Count Reload Register B */
};
dmaGblRegMsk = DMA_globalAlloc(dmaGblRegId);
DMA_globalConfig(dmaGblRegMsk, &dmaGblCfg);

```

DMA_globalConfigArgs

DMA_globalConfigArgs *Establishes DMA global register value*

Function	<pre>void DMA_globalConfigArgs(Uint32 regs, Uint32 addrA, Uint32 addrB, Uint32 addrC, Uint32 addrD, Uint32 idxA, Uint32 idxB, Uint32 cntA, Uint32 cntB);</pre>																		
Arguments	<table><tr><td>regs</td><td>DMA global register mask value.</td></tr><tr><td>addrA</td><td>Global address register A value.</td></tr><tr><td>addrB</td><td>Global address register B value.</td></tr><tr><td>addrC</td><td>Global address register C value.</td></tr><tr><td>addrD</td><td>Global address register D value.</td></tr><tr><td>idxA</td><td>Global index register A value.</td></tr><tr><td>idxB</td><td>Global index register B value.</td></tr><tr><td>cntA</td><td>Global count reload register A value.</td></tr><tr><td>cntB</td><td>Global count reload register B value.</td></tr></table>	regs	DMA global register mask value.	addrA	Global address register A value.	addrB	Global address register B value.	addrC	Global address register C value.	addrD	Global address register D value.	idxA	Global index register A value.	idxB	Global index register B value.	cntA	Global count reload register A value.	cntB	Global count reload register B value.
regs	DMA global register mask value.																		
addrA	Global address register A value.																		
addrB	Global address register B value.																		
addrC	Global address register C value.																		
addrD	Global address register D value.																		
idxA	Global index register A value.																		
idxB	Global index register B value.																		
cntA	Global count reload register A value.																		
cntB	Global count reload register B value.																		
Return Value	none																		
Description	Sets up the DMA global registers using the register values passed in. The register values that are written to the DMA global registers depend on the DMA global register mask.																		

Example

```
Uint32 dmaGblRegMsk;
    Uint32 dmaGblRegId = DMA_GBLADDRB | DMA_GBLADDRC;
    Uint32 addrA = 0x00000000;
    Uint32 addrB = 0x80001000;
    Uint32 addrC = 0x80002000;
    Uint32 addrD = 0x00000000;
    Uint32 idxA = 0x00000000;
    Uint32 idxB = 0x00000000;
    Uint32 cntA = 0x00000000;
    Uint32 cntB = 0x00000000;
    dmaGblRegMsk = DMA_globalAlloc(dmaGblRegId);
    DMA_globalConfigArgs(
        dmaGblRegMsk,
        addrA,
        addrB,
        addrC,
        addrD,
        idxA,
        idxB,
        cntA,
        cntB
    );
```

DMA_globalFree

DMA_globalFree *Frees allocated DMA global registers*

Function	Void DMA_globalFree(Uint32 regs);
Arguments	regs DMA global registers ID
Return Value	none
Description	Frees previously allocated DMA global registers; depends on regs.
Example	<pre>Uint32 dmaGblRegId = DMA_GBLADDRB DMA_GBLADDRB; DMA_globalFree(dmaGblRegId);</pre>

DMA_globalGetConfig *Gets current DMA global register configuration value*

Function	void DMA_globalGetConfig(Uint32 regs, DMA_GlobalConfig *cfg);
Arguments	regs DMA global register ID cfg Pointer to an initialized configuration structure.
Return Value	none
Description	Gets DMA global registers current configuration value depending on DMA global register ID.
Example	<pre>Uint32 dmaGblRegId = DMA_GBLADDRB DMA_GBLADDRB; DMA_GlobalConfig dmaGblCfg; DMA_globalGetConfig(dmaGblRegId, &dmaGblCfg);</pre>

DMA_setGlobalReg *Sets value of global DMA register that was previously allocated*

Function	void DMA_setGlobalReg(Uint32 regId, Uint32 val);
Arguments	regId Global register ID obtained from DMA_allocGlobalReg(). val Value to set register to
Return Value	none
Description	This function sets the value of a global DMA register that was previously allocated by calling DMA_allocGlobalReg().
Example	<pre> Uint32 RegId; ... /* allocate global index register and initialize it / RegId = DMA_allocGlobalReg(DMA_GBL_INDEX, 0x00200040); ... DMA_setGlobalReg(RegId, 0x12345678); </pre>

6.4.3 DMA Auxiliary Functions, Constants, and Macros**DMA_autoStart** *Starts DMA channel with autoinitialization*

Function	void DMA_autoStart(DMA_Handle hDma);
Arguments	hDma Handle to DMA channel, see DMA_open()
Return Value	none
Description	Starts a DMA channel running with autoinitialization by setting the START bits in the primary control register accordingly. See also DMA_pause(), DMA_stop(), and DMA_start().
Example	DMA_autoStart(hDma);

DMA_CHA_CNT

DMA_CHA_CNT *Number of DMA channels for current device*

Constant	DMA_CHA_CNT
Description	This constant holds the number of physical DMA channels for the current device.

DMA_CLEAR_CONDITION *Clears one of the condition flags in DMA secondary control register*

Macro	DMA_CLEAR_CONDITION(hDma, COND);				
Arguments	<table><tr><td>hDma</td><td>Handle to DMA channel, see <code>DMA_open()</code></td></tr><tr><td>COND</td><td>Condition to clear, must be one of the following:<ul style="list-style-type: none"><input type="checkbox"/> DMA_SECCTL_SXCOND<input type="checkbox"/> DMA_SECCTL_FRAMECOND<input type="checkbox"/> DMA_SECCTL_LASTCOND<input type="checkbox"/> DMA_SECCTL_BLOCKCOND<input type="checkbox"/> DMA_SECCTL_RDROPCOND<input type="checkbox"/> DMA_SECCTL_WDROPCOND</td></tr></table>	hDma	Handle to DMA channel, see <code>DMA_open()</code>	COND	Condition to clear, must be one of the following: <ul style="list-style-type: none"><input type="checkbox"/> DMA_SECCTL_SXCOND<input type="checkbox"/> DMA_SECCTL_FRAMECOND<input type="checkbox"/> DMA_SECCTL_LASTCOND<input type="checkbox"/> DMA_SECCTL_BLOCKCOND<input type="checkbox"/> DMA_SECCTL_RDROPCOND<input type="checkbox"/> DMA_SECCTL_WDROPCOND
hDma	Handle to DMA channel, see <code>DMA_open()</code>				
COND	Condition to clear, must be one of the following: <ul style="list-style-type: none"><input type="checkbox"/> DMA_SECCTL_SXCOND<input type="checkbox"/> DMA_SECCTL_FRAMECOND<input type="checkbox"/> DMA_SECCTL_LASTCOND<input type="checkbox"/> DMA_SECCTL_BLOCKCOND<input type="checkbox"/> DMA_SECCTL_RDROPCOND<input type="checkbox"/> DMA_SECCTL_WDROPCOND				
Return Value	none				
Description	This macro clears one of the condition flags in the DMA secondary control register. See the <i>TMS320C6000 Peripherals Reference Guide</i> (SPRU190) for a description of the condition flags.				
Example	<code>DMA_CLEAR_CONDITION(hDma, DMA_SECCTL_BLOCKCOND);</code>				

DMA_GBLADDRA *DMA global address register A mask*

Constant	DMA_GBLADDRA
Description	This constant allows selection of the global address register A. See <code>DMA_globalAlloc()</code> , <code>DMA_globalConfig()</code> , and <code>DMA_globalConfigArgs()</code> functions.

DMA_GBLADDRB *DMA global address register B mask*

Constant	DMA_GBLADDRB
Description	This constant allows selection of the global address register B. See <code>DMA_globalAlloc()</code> , <code>DMA_globalConfig()</code> , and <code>DMA_globalConfigArgs()</code> functions.

DMA_GBLADDRC *DMA global address register C mask*

Constant	DMA_GBLADDRC
Description	This constant allows selection of the global address register C. See <code>DMA_globalAlloc()</code> , <code>DMA_globalConfig()</code> , and <code>DMA_globalConfigArgs()</code> functions.

DMA_GBLADDRD *DMA global address register D mask*

Constant	DMA_GBLADDRD
Description	This constant allows selection of the global address register D. See <code>DMA_globalAlloc()</code> , <code>DMA_globalConfig()</code> , and <code>DMS_globalConfigArgs()</code> functions.

DMA_GBLCNTA *DMA global count reload register A mask*

Constant	DMA_GBLCNTA
Description	This constant allows selection of the global count reload register A. See <code>DMA_globalAlloc()</code> , <code>DMA_globalConfig()</code> , and <code>DMA_globalConfigArgs()</code> functions.

DMA_GBLCNTB *DMA global count reload register B mask*

Constant	DMA_GBLCNTB
Description	This constant allows selection of the global count reload register B. See <code>DMA_globalAlloc()</code> , <code>DMA_globalConfig()</code> , and <code>DMA_globalConfigArgs()</code> functions.

DMA_GBLIDXA *DMA global index register A mask*

Constant	DMA_GBLIDXA
Description	This constant allows selection of the global index register A. See <code>DMA_globalAlloc()</code> , <code>DMA_globalConfigArgs()</code> , and <code>DMA_globalConfig()</code> functions.

DMA_GBLIDX

DMA_GBLIDX *DMA global index register B mask*

Constant	DMA_GBLIDX
Description	This constant allows selection of the global index register B. See <code>DMA_globalAlloc()</code> , <code>DMA_globalConfig()</code> , and <code>DMA_globalConfigArgs()</code> functions.

DMA_GET_CONDITION *Gets one of the condition flags in DMA secondary control register*

Macro	<code>DMA_GET_CONDITION(hDma, COND);</code>
Arguments	<code>hDma</code> Handle to DMA channel. See <code>DMA_open()</code> <code>COND</code> Condition to get; must be one of the following: <input type="checkbox"/> <code>DMA_SECCTL_SXCOND</code> <input type="checkbox"/> <code>DMA_SECCTL_FRAMECOND</code> <input type="checkbox"/> <code>DMA_SECCTL_LASTCOND</code> <input type="checkbox"/> <code>DMA_SECCTL_BLOCKCOND</code> <input type="checkbox"/> <code>DMA_SECCTL_RDROPCOND</code> <input type="checkbox"/> <code>DMA_SECCTL_WDROPCOND</code>
Return Value	Condition Condition, 0 if clear, 1 if set
Description	This macro gets one of the condition flags in the DMA secondary control register. See the <i>TMS320C6000 Peripherals Reference Guide (SPRU190)</i> for a description of the condition flags.
Example	<pre>if (DMA_GET_CONDITION(hDma, DMA_SECCTL_BLOCKCOND)) { /* user DMA configuration */ }</pre>

DMA_getConfig *Reads the current DMA configuration values*

Function	<code>void DMA_getConfig(DMA_Handle hDma, DMA_Config *config);</code>
Arguments	<code>hDma</code> DMA handle. See <code>DMA_open()</code> <code>config</code> Pointer to a configuration structure

Return Value	none
Description	Get DMA current configuration value
Example	<pre>DMA_config dmaCfg; DMA_getConfig(hDma, &dmaCfg);</pre>

DMA_getEventId *Returns IRQ event ID for DMA completion interrupt*

Function	<pre>Uint32 DMA_getEventId(DMA_Handle hDma);</pre>
Arguments	hDma Handle to DMA channel. See DMA_open()
Return Value	Event ID IRQ Event ID for DMA Channel
Description	Returns the IRQ Event ID for the DMA completion interrupt. Use this ID to manage the event using the IRQ module.
Example	<pre>EventId = DMA_getEventId(hDma); IRQ_enable(EventId);</pre>

DMA_getStatus *Reads status bits of DMA channel*

Function	<pre>Uint32 DMA_getStatus(DMA_Handle hDma);</pre>
Arguments	hDma Handle to DMA channel, see DMA_open()
Return Value	Status Value Current DMA channel status: <ul style="list-style-type: none"> <input type="checkbox"/> DMA_STATUS_STOPPED <input type="checkbox"/> DMA_STATUS_RUNNING <input type="checkbox"/> DMA_STATUS_PAUSED <input type="checkbox"/> DMA_STATUS_AUTORUNNING
Description	This function reads the STATUS bits of the DMA channel.
Example	<pre>while (DMA_getStatus(hDma) == DMA_STATUS_RUNNING);</pre>

DMA_restoreStatus *Restores the status from DMA_getStatus()*

Function	<pre>void DMA_restoreStatus(Uint32 hDma, Uint32 status);</pre>
Arguments	hDma Handle to DMA channel. See DMA_open() status Status from DMA_getStatus() function

DMA_setAuxCtl

Return Value	none
Description	Restores the status from <code>DMA_getStatus()</code> by setting the START bit of the PRICTL primary control register.
Example	<pre>status = DMA_getStatus(hDma); ... DMA_restoreStatus(hDma, status);</pre>

DMA_setAuxCtl *Sets DMA AUXCTL register*

Function	<pre>void DMA_setAuxCtl(Uint32 auxCtl);</pre>
Arguments	<code>auxCtl</code> Value to set AUXCTL register to
Return Value	none
Description	This function sets the DMA AUXCTL register. You may use the <code>DMA_AUXCTL_RMK</code> macro to construct the register value based on field values. The default value for this register is <code>DMA_AUXCTL_DEFAULT</code> .
Example	<pre>DMA_setAuxCtl(0x00000000);</pre>

DMA_SUPPORT *Compile time constant*

Constant	<code>DMA_SUPPORT</code>
Description	Compile time constant that has a value of 1 if the device supports the DMA module and 0 otherwise. You are not required to use this constant.

Note:

The DMA module is not supported on devices that do not have the DMA peripheral. In these cases, the EDMA module is supported instead.

Example	<pre>#if (DMA_SUPPORT) /* user DMA configuration / #elif (EDMA_SUPPORT) / user EDMA configuration */ #endif</pre>
----------------	---

DMA_wait *Enters spin loop that polls DMA status bits until DMA completes*

Function	<pre>void DMA_wait(DMA_Handle hDma);</pre>
Arguments	hDma Handle to DMA channel. See <code>DMA_open()</code>
Return Value	none
Description	<p>This function enters a spin loop that polls the DMA status bits until the DMA completes. Interrupts are not disabled during this loop. This function is equivalent to the following line of code:</p> <pre>while (DMA_getStatus(hDma) & DMA_STATUS_RUNNING);</pre>
Example	<pre>DMA_wait(hDma);</pre>

EDMA Module

This chapter describes the EDMA module, lists the API functions and macros within the module, discusses how to use an EDMA channel, and provides an EDMA API reference section.

Topic	Page
7.1 Overview	7-2
7.2 Macros	7-5
7.3 Configuration Structure	7-7
7.4 Functions	7-8

7.1 Overview

Currently, there are two DMA architectures used on C6x devices: DMA and EDMA (Enhanced DMA). Devices such as the C6201™ have the DMA peripheral whereas C6211™ devices have the EDMA peripheral. The two architectures are different enough to warrant a separate API module for each.

Table 7–1 lists the configuration structures for use with the EDMA functions. Table 7–2 lists the functions and constants available in the CSL EDMA module.

Table 7–1. EDMA Configuration Structure

Structure	Purpose	See page ...
EDMA_Config	The EDMA configuration structure used to set up an EDMA channel	7-7

Table 7–2. EDMA APIs

(a) EDMA Primary Functions

Syntax	Type	Description	See page ...
EDMA_close	F	Closes a previously opened EDMA channel	7-8
EDMA_config	F	Sets up the EDMA channel using the configuration structure	7-8
EDMA_configArgs	F	Sets up the EDMA channel using the EDMA parameter arguments	7-9
EDMA_open	F	Opens an EDMA channel	7-10
EDMA_reset	F	Resets the given EDMA channel	7-15

(b) EDMA Auxiliary Functions and Constants

Syntax	Type	Description	See page ...
EDMA_allocTable	F	Allocates a parameter RAM table from PRAM	7-16
EDMA_allocTableEx	F	Allocates set of parameter RAM tables from PRAM	7-17
EDMA_CHA_CNT	C	Number of EDMA channels	7-17
EDMA_chain	F	Sets the TCC,TCINT fields of the parent EDMA handle	7-18
EDMA_clearChannel	F	Clears the EDMA event flag in the EDMA channel event register	7-19
EDMA_clearPram	F	Clears the EDMA parameter RAM (PRAM)	7-20

Note: F = Function; C = Constant

Table 7–2. EDMA APIs (Continued)

Syntax	Type	Description	See page ...
EDMA_disableChaining	F	Disables EDMA chaining	7-20
EDMA_enableChaining	F	Enables EDMA chaining	7-20
EDMA_disableChannel	F	Disables an EDMA channel	7-21
EDMA_enableChannel	F	Enables an EDMA channel	7-21
EDMA_freeTable	F	Frees up a PRAM table previously allocated	7-22
EDMA_freeTableEx	F	Frees a previously allocated set of parameter RAM tables	7-22
EDMA_getChannel	F	Returns the current state of the channel event	7-23
EDMA_getConfig	F	Reads the current EDMA configuration values	7-23
EDMA_getPriQStatus	F	Returns the value of the priority queue status register (PQSR)	7-24
EDMA_getScratchAddr	F	Returns the starting address of the EDMA PRAM used as non-cacheable on-chip SRAM (scratch area)	7-24
EDMA_getScratchSize	F	Returns the size (in bytes) of the EDMA PRAM used as non-cacheable on-chip SRAM (scratch area)	7-24
EDMA_getTableAddress	F	Returns the 32-bit absolute address of the table	7-25
EDMA_intAlloc	F	Allocates a transfer complete code	7-25
EDMA_intClear	F	Clears EDMA transfer completion interrupt pending flag	7-25
EDMA_intDefaultHandler	F	Default function called by EDMA_intDispatcher()	7-26
EDMA_intDisable	F	Disables EDMA transfer completion interrupt	7-26
EDMA_intDispatcher	F	Calls an ISR when CIER[x] and CIPR[x] are both set	7-26
EDMA_intEnable	F	Enables EDMA transfer completion interrupt	7-27
EDMA_intFree	F	Frees a transfer complete code previously allocated	7-27
EDMA_intHook	F	Hooks to an ISR channel which is called by EDMA_intDispatcher()	7-28
EDMA_intTest	F	Tests EDMA transfer completion interrupt pending flag	7-29
EDMA_link	F	Links two EDMA transfers together	7-29
EDMA_qdmaConfig	F	Sets up QDMA registers using configuration structure	7-30
EDMA_qdmaConfigArgs	F	Sets up QDMA registers using arguments	7-31

Note: F = Function; C = Constant

Table 7–2. EDMA APIs (Continued)

Syntax	Type	Description	See page ...
EDMA_resetAll	F	Resets all EDMA channels supported by the chip device	7-32
EDMA_resetPriQLength	F	Resets the Priority queue length to the default value	7-32
EDMA_setChannel	F	Triggers an EDMA channel by writing to the appropriate bit in the event set register (ESR)	7-32
EDMA_setEvtPolarity	F	Sets the polarity of the event associated with the EDMA handle.	7-33
EDMA_setPriQLength	F	Sets the length of a given priority queue allocation register	7-33
EDMA_SUPPORT	C	A compile-time constant whose value is 1 if the device supports the EDMA module	7-34
EDMA_TABLE_CNT	C	A compile-time constant that holds the total number of parameter table entries in the EDMA PRAM	7-34

Note: F = Function; C = Constant

7.1.1 Using an EDMA Channel

To use an EDMA channel, you must first open it and obtain a device handle using `EDMA_open()`. Once opened, use the device handle to call the other API functions. The channel may be configured by passing an `EDMA_Config` structure to `EDMA_config()` or by passing register values to the `EDMA_configArgs()` function. To assist in creating register values, the `_RMK` (make) macros construct register values based on field values. In addition, the symbol constants may be used for the field values.

Two functions manage the parameter RAM (PRAM) tables: `EDMA_allocTable()` and `EDMA_freeTable()`.

7.2 Macros

There are two types of EDMA macros: those that access registers and fields, and those that construct register and field values.

Table 7–3 lists the EDMA macros that access registers and fields, and Table 7–4 lists the EDMA macros that construct register and field values. The macros themselves are found in Chapter 28, *Using the HAL Macros*.

The EDMA module includes handle-based macros.

Table 7–3. EDMA Macros That Access Registers and Fields

Macro	Description/Purpose	See page...
EDMA_ADDR(<REG>)	Register address	28-12
EDMA_RGET(<REG>)	Returns the current value of a register	28-18
EDMA_RSET(<REG>,x)	Register set	28-20
EDMA_FGET(<REG>,<FIELD>)	Returns the value of the specified field in a register	28-13
EDMA_FSET(<REG>,<FIELD>,x)	Writes <i>fieldval</i> to the specified field in a register	28-15
EDMA_FSETS(<REG>,<FIELD>,<SYM>)	Writes the symbol value to the specified field in the peripheral	28-17
EDMA_RGETA(addr,<REG>)	Gets register value for a given address	28-19
EDMA_RSETA(addr,<REG>,x)	Sets register for a given address	28-20
EDMA_FGETA(addr,<REG>,<FIELD>)	Gets field for a given address	28-13
EDMA_FSETA(addr,<REG>,<FIELD>,x)	Sets field for a given address	28-16
EDMA_FSETSA(addr,<REG>,<FIELD>,<SYM>)	Sets field symbolically for a given address	28-17
EDMA_ADDRH(h,<REG>)	Returns the address of a memory-mapped register for a given handle	28-12
EDMA_RGETH(h,<REG>)	Returns the value of a register for a given handle	28-19
EDMA_RSETH(h,<REG>,x)	Sets the register value to x for a given handle	28-21
EDMA_FGETH(h,<REG>,<FIELD>)	Returns the value of the field for a given handle	28-14
EDMA_FSETH(h,<REG>,<FIELD>,x)	Sets the field value to x for a given handle	28-16
EDMA_FSETSH(h,<REG>,<FIELD>,<SYM>)	Sets the field symbolically for a given handle	28-18

Table 7–4. EDMA Macros that Construct Register and Field Values

Macro	Description/Purpose	See page...
EDMA_<REG>_DEFAULT	Register default value	28-21
EDMA_<REG>_RMK()	Register make	28-23
EDMA_<REG>_OF()	Register value of ...	28-22
EDMA_<REG>_<FIELD>_DEFAULT	Field default value	28-24
EDMA_FMK()	Field make	28-14
EDMA_FMKS()	Field make symbolically	28-15
EDMA_<REG>_<FIELD>_OF()	Field value of ...	28-24
EDMA_<REG>_<FIELD>_<SYM>	Field symbolic value	28-24

7.3 Configuration Structure

EDMA_Config *EDMA configuration structure used to set up EDMA channel*

Structure	EDMA_Config	
Members	Uint32 opt	Options
	Uint32 src	Source address
	Uint32 cnt	Transfer count
	Uint32 dst	Destination address
	Uint32 idx	Index
	Uint32 rld	Element count reload and link address
Description	This is the EDMA configuration structure used to set up an EDMA channel. You create and initialize this structure and then pass its address to the <code>EDMA_config()</code> function.	
Example	<pre>EDMA_Config myConfig = { 0x41200000, /* opt */ 0x80000000, /* src */ 0x00000040, /* cnt */ 0x80010000, /* dst */ 0x00000004, /* idx */ 0x00000000 /* rld */ }; ... EDMA_config(hEdma, &myConfig);</pre>	

EDMA_close

7.4 Functions

7.4.1 EDMA Primary Functions

EDMA_close *Closes previously opened EDMA channel*

Function	<pre>void EDMA_close(EDMA_Handle hEdma);</pre>
Arguments	<code>hEdma</code> Device handle. See <code>EDMA_open()</code> .
Return Value	none
Description	<p>Closes a previously opened EDMA channel.</p> <p>This function accepts the following device handle:</p> <ul style="list-style-type: none">From <code>EDMA_open()</code>
Example	<pre>EDMA_close(hEdma);</pre>

EDMA_config *Sets up EDMA channel using configuration structure*

Function	<pre>void EDMA_config(EDMA_Handle hEdma, EDMA_Config *config);</pre>
Arguments	<code>hEdma</code> Device handle. See <code>EDMA_open()</code> and <code>EDMA_allocTable()</code> .
	<code>config</code> Pointer to an initialized configuration structure
Return Value	none
Description	<p>Sets up the EDMA channel using the configuration structure. The values of the structure are written to the EDMA PRAM entries. The options value (<i>opt</i>) is written last. See also <code>EDMA_configArgs()</code> and <code>EDMA_Config</code>.</p> <p>This function accepts the following device handles:</p> <ul style="list-style-type: none"><input type="checkbox"/> From <code>EDMA_open()</code><input type="checkbox"/> From <code>EDMA_allocTable()</code>

```

Example      EDMA_Config myConfig = {
                0x41200000, /* opt */
                0x80000000, /* src */
                0x00000040, /* cnt */
                0x80010000, /* dst */
                0x00000004, /* idx */
                0x00000000 /* rld */
                };
                ...
                EDMA_config(hEdma, &myConfig);

```

EDMA_configArgs *Sets up EDMA channel using EDMA parameter arguments*

Function	void EDMA_configArgs(EDMA_Handle hEdma, Uint32 opt, Uint32 src, Uint32 cnt, Uint32 dst, Uint32 idx, Uint32 rld);
Arguments	<p>hEdma Device handle. See EDMA_open() and EDMA_allocTable().</p> <p>opt Options</p> <p>src Source address</p> <p>cnt Transfer count</p> <p>dst Destination address</p> <p>idx Index</p> <p>rld Element count reload and link address</p>
Return Value	none
Description	<p>Sets up the EDMA channel using the EDMA parameter arguments. The values of the arguments are written to the EDMA PRAM entries. The options value (<i>opt</i>) is written last. See also EDMA_config().</p> <p>This function accepts the following device handles:</p>

EDMA_open

- From EDMA_open()
- From EDMA_allocTable()

Example

```
EDMA_configArgs(hEdma,  
    0x41200000, /* opt */  
    0x80000000, /* src */  
    0x00000040, /* cnt */  
    0x80010000, /* dst */  
    0x00000004, /* idx */  
    0x00000000 /* rld */  
);
```

EDMA_open

Opens EDMA channel

Function

```
EDMA_Handle EDMA_open(  
    int chaNum,  
    Uint32 flags  
);
```

Arguments

chaNum EDMA channel to open:
(For C6201, C6202, C6203, C6204, C6205, C6701, C6211, C6711, C6711C,
C6712 and C6712C)

- EDMA_CHA_ANY
- EDMA_CHA_DSPINT
- EDMA_CHA_TINT0
- EDMA_CHA_TINT1
- EDMA_CHA_SDINT
- EDMA_CHA_EXTINT4
- EDMA_CHA_EXTINT5
- EDMA_CHA_EXTINT6
- EDMA_CHA_EXTINT7
- EDMA_CHA_TCC8
- EDMA_CHA_TCC9
- EDMA_CHA_TCC10
- EDMA_CHA_TCC11
- EDMA_CHA_XEVT0
- EDMA_CHA_REVT0
- EDMA_CHA_XEVT1
- EDMA_CHA_REVT1
- EDMA_CHA_ANY
- EDMA_CHA_DSPINT
- EDMA_CHA_TINT0

- EDMA_CHA_TINT1
- EDMA_CHA_SDINT
- EDMA_CHA_EXTINT4
- EDMA_CHA_EXTINT5
- EDMA_CHA_EXTINT6
- EDMA_CHA_EXTINT7
- EDMA_CHA_TCC8
- EDMA_CHA_TCC9
- EDMA_CHA_TCC10
- EDMA_CHA_TCC11
- EDMA_CHA_XEVT0
- EDMA_CHA_REVT0
- EDMA_CHA_XEVT1
- EDMA_CHA_REVT1

(In addition, for C6711C and C6712C)

- EDMA_CHA_GPINT4
- EDMA_CHA_GPINT5
- EDMA_CHA_GPINT6
- EDMA_CHA_GPINT7
- EDMA_CHA_GPINT2

(For C6713, DA610, C6414, C6415, C6416, DM642, DM641, DM640, C6412, C6413, and C6418)

- EDMA_CHA_ANY
- EDMA_CHA_DSPINT
- EDMA_CHA_TINT0
- EDMA_CHA_TINT1
- EDMA_CHA_SDINT
- EDMA_CHA_EXTINT4
- EDMA_CHA_GPINT4
- EDMA_CHA_EXTINT5
- EDMA_CHA_GPINT5
- EDMA_CHA_EXTINT6
- EDMA_CHA_GPINT6
- EDMA_CHA_EXTINT7
- EDMA_CHA_GPINT7
- EDMA_CHA_TCC8
- EDMA_CHA_GPINT0
- EDMA_CHA_TCC9
- EDMA_CHA_GPINT1
- EDMA_CHA_TCC10
- EDMA_CHA_GPINT2

EDMA_open

- EDMA_CHA_TCC11
- EDMA_CHA_GPINT3
- EDMA_CHA_XEVT0
- EDMA_CHA_REVT0
- EDMA_CHA_XEVT1
- EDMA_CHA_REVT1
- EDMA_CHA_GPINT8
- EDMA_CHA_GPINT9
- EDMA_CHA_GPINT10
- EDMA_CHA_GPINT11
- EDMA_CHA_GPINT12
- EDMA_CHA_GPINT13
- EDMA_CHA_GPINT14
- EDMA_CHA_GPINT15

(In addition, for C6713 and DA610)

- EDMA_CHA_AXEVTE0
- EDMA_CHA_AXEVTO0
- EDMA_CHA_AXEVT0
- EDMA_CHA_AREVTE0
- EDMA_CHA_AREVTO0
- EDMA_CHA_AREVT0
- EDMA_CHA_AXEVTE1
- EDMA_CHA_AXEVTO1
- EDMA_CHA_AXEVT1
- EDMA_CHA_AREVTE1
- EDMA_CHA_AREVTO1
- EDMA_CHA_AREVT1
- EDMA_CHA_ICREVT0
- EDMA_CHA_ICXEVT0
- EDMA_CHA_ICREVT1
- EDMA_CHA_ICXEVT1

(In addition, for C6410, C6413, and C6418)

- EDMA_CHA_TINT2
- EDMA_CHA_VCPREVT0#
- EDMA_CHA_VCPXEVT0#
- EDMA_CHA_AXEVTE0
- EDMA_CHA_AXEVTO0
- EDMA_CHA_AXEVT0
- EDMA_CHA_AREVTE0
- EDMA_CHA_AREVTO0
- EDMA_CHA_AREVT0

- EDMA_CHA_AXEVTE1
- EDMA_CHA_AXEVTO1
- EDMA_CHA_AXEVT1
- EDMA_CHA_AXEVTE1
- EDMA_CHA_AXEVTO1
- EDMA_CHA_AXEVT1
- EDMA_CHA_ICREVT0
- EDMA_CHA_ICXEVT0
- EDMA_CHA_ICREVT1
- EDMA_CHA_ICXEVT1

Defined only for C6418

(In addition, for DM642, DM641, and DM640)

- EDMA_CHA_VP0EVTYA
- EDMA_CHA_VP0EVTUA
- EDMA_CHA_VP0EVTVA
- EDMA_CHA_TINT2
- EDMA_CHA_ICREVT0
- EDMA_CHA_ICXEVT0
- EDMA_CHA_VP0EVTYB#
- EDMA_CHA_VP0EVTUB#
- EDMA_CHA_VP0EVTVB#
- EDMA_CHA_AXEVTE0
- EDMA_CHA_AXEVTO0
- EDMA_CHA_AXEVT0
- EDMA_CHA_AREVT0
- EDMA_CHA_AREVT0
- EDMA_CHA_AREVT0
- EDMA_CHA_VP1EVTYB#
- EDMA_CHA_VP1EVTUB#
- EDMA_CHA_VP1EVTVB#
- EDMA_CHA_VP2EVTYB#
- EDMA_CHA_VP2EVTUB#
- EDMA_CHA_VP2EVTVB#
- EDMA_CHA_VP1EVTYA
- EDMA_CHA_VP1EVTUA
- EDMA_CHA_VP1EVTVA
- EDMA_CHA_VP2EVTYA@
- EDMA_CHA_VP2EVTUA@
- EDMA_CHA_VP2EVTVA@

@ Only for DM642 and DM641

Only for DM642

EDMA_open

(In addition, for C6414, C6415 and C6416)

- EDMA_CHA_XEVT2
- EDMA_CHA_REVT2
- EDMA_CHA_TINT2
- EDMA_CHA_SDINTB
- EDMA_CHA_PCI
- EDMA_CHA_VCPREVT
- EDMA_CHA_VCPXEVT
- EDMA_CHA_TCPREVT
- EDMA_CHA_TCPXEVT
- EDMA_CHA_UREVT
- EDMA_CHA_UREVT0
- EDMA_CHA_UREVT1
- EDMA_CHA_UREVT2
- EDMA_CHA_UREVT3
- EDMA_CHA_UREVT4
- EDMA_CHA_UREVT5
- EDMA_CHA_UREVT6
- EDMA_CHA_UREVT7
- EDMA_CHA_UXEVT
- EDMA_CHA_UXEVT0
- EDMA_CHA_UXEVT1
- EDMA_CHA_UXEVT2
- EDMA_CHA_UXEVT3
- EDMA_CHA_UXEVT4
- EDMA_CHA_UXEVT5
- EDMA_CHA_UXEVT6
- EDMA_CHA_UXEVT7

(In addition, for C6412)

- EDMA_CHA_TINT2
- EDMA_CHA_PCI
- EDMA_CHA_MACEVT
- EDMA_CHA_ICREVT0
- EDMA_CHA_ICXEVT0

flags Open flags, logical OR of any of the following:

- EDMA_OPEN_RESET
- EDMA_OPEN_ENABLE

Return Value

Device Handle Device handle to be used by other EDMA API function calls.

Description Before an EDMA channel can be used, it must first be opened by this function. Once opened, it cannot be opened again until closed. See `EDMA_close()`. You have the option of either specifying exactly which physical channel to open or you can let the library pick an unused one for you by specifying `EDMA_CHA_ANY`. The return value is a unique device handle that you use in subsequent EDMA API calls. If the open fails, `INV` is returned.

If the `EDMA_OPEN_RESET` is specified, the EDMA channel is reset and the channel interrupt is disabled and cleared. If the `EDMA_OPEN_ENABLE` flag is specified, the channel will be enabled.

If the channel cannot be opened, `INV` is returned.

Note: If the DAT module is open [see `DAT_open()`], then EDMA transfer completion interrupts 1 through 4 are reserved.

Refer to the *TMS320C6000 Peripherals Reference Guide* (SPRU190) for details regarding the EDMA channels.

Example

```
EDMA_Handle hEdma;
...
hEdma = EDMA_open(EDMA_CHA_TINT0, EDMA_OPEN_RESET);
...
```

EDMA_reset	<i>Resets given EDMA channel</i>
------------	----------------------------------

Function	void EDMA_reset(EDMA_Handle hEdma);
Arguments	hEdma Device handle obtained by <code>EDMA_open()</code> .
Return Value	none
Description	Resets the given EDMA channel. The following steps are taken: <ul style="list-style-type: none"> <input type="checkbox"/> The channel is disabled <input type="checkbox"/> The channel event flag is cleared This function accepts the following device handle: <p style="margin-left: 40px;">From <code>EDMA_open()</code></p>
Example	<code>EDMA_reset(hEdma);</code>

EDMA_allocTable

7.4.2 EDMA Auxiliary Functions and Constants

EDMA_allocTable *Allocates a parameter RAM table from PRAM*

Function	<code>EDMA_Handle EDMA_allocTable(int tableNum);</code>
Arguments	<code>tableNum</code> Table number to allocate. Valid values are 0 to <code>EDMA_TABLE_CNT-1</code> ; <code>-1</code> for any.
Return Value	Device Handle Returns a device handle
Description	<p>This function allocates the PRAM tables dedicated to the Reload/Link parameters. You use the Reload/Link PRAM tables for linking transfers together. You can either specify a table number or specify <code>-1</code> and the function will pick an unused one for you. The return value is a device handle and may be used for APIs that require a device handle. If the table could not be allocated, then <code>INV</code> is returned.</p> <p>If you finish with the table and wish to free it up again, call <code>EDMA_freeTable()</code>.</p> <p>For TMS320C621x/C671x, the first two tables located at 0x01A00180 and 0x01A00198, respectively, are reserved. The first parameter table is initialized to zero, and the second table is reserved for CSL code. The first available table for the user starts at address 0x01A001B0. There are 67 available tables, with table numbers from 0 to 66.</p> <p>For TMS320C64xx, the first two tables located at 0x01A00600 and 0x01A00618 are reserved. The first parameter table is initialized to zero, and the second table is reserved for CSL code. The first available table for the user starts at address 0x01A00630. There are 19 available tables, with table numbers from 0 to 18.</p> <pre>hEdmaTable=EDMA_allocTable(0);</pre> <p>will allocate the Reload/Link parameter table located at:</p> <ul style="list-style-type: none"><input type="checkbox"/> 0x01A001B0 for C621x/C671x devices<input type="checkbox"/> 0x01A00630 for C64xx devices <p>Example</p> <pre>EDMA_Handle hEdmaTable; ... hEdmaTable = EDMA_allocTable(-1);</pre>

EDMA_allocTableEx *Allocates set of parameter RAM tables from PRAM*

Function	<pre>int EDMA_allocTableEx(int cnt, EDMA_Handle *array);</pre>				
Arguments	<table><tr><td>cnt</td><td>Number of tables to allocate</td></tr><tr><td>array</td><td>An array to hold the table handles for each table allocated</td></tr></table>	cnt	Number of tables to allocate	array	An array to hold the table handles for each table allocated
cnt	Number of tables to allocate				
array	An array to hold the table handles for each table allocated				
Return Value	numAllocated Returns the actual number of tables allocated. It will either be cnt or 0.				
Description	<p>This function allocates a set of parameter RAM tables from PRAM. The tables are not guaranteed to be contiguous in memory. You use PRAM tables for linking transfers together. The array passed in is filled with table handles and each one may be used for APIs that require a device handle.</p> <p>If you finish with the tables and wish to free them up again, call EDMA_freeTableEx().</p>				
Example	<pre>EDMA_Handle hEdmaTableArray[16]; ... if (EDMA_allocTableEx(16,hEdmaTableArray)) { ... }</pre>				

EDMA_CHA_CNT *Number of EDMA channels*

Constant	EDMA_CHA_CNT
Description	Compile time constant that holds the number of EDMA channels.

EDMA_chain

EDMA_chain

Sets the TCC, TCINT fields of the parent EDMA handle

Function	<pre>void EDMA_chain(EDMA_Handle parent, EDMA_Handle nextChannel, int flag_tcc, int flag_atcc);</pre>								
Arguments	<table><tr><td>parent</td><td>EDMA handle following the chainable transfer.</td></tr><tr><td>nextChannel</td><td>EDMA handle associated with the channel to be chained.</td></tr><tr><td>flag_tcc</td><td>Flag for TCC,TCINT setting (and TCCM for C64x devices). The following constants must be used: <input type="checkbox"/> 0 <input type="checkbox"/> EDMA_TCC_SET or 1</td></tr><tr><td>flag_atcc</td><td>Flag for ATCC, ATCINT setting (C64x devices only). The following constants must be used: <input type="checkbox"/> 0 <input type="checkbox"/> EDMA_ATCC_SET or 1</td></tr></table>	parent	EDMA handle following the chainable transfer.	nextChannel	EDMA handle associated with the channel to be chained.	flag_tcc	Flag for TCC,TCINT setting (and TCCM for C64x devices). The following constants must be used: <input type="checkbox"/> 0 <input type="checkbox"/> EDMA_TCC_SET or 1	flag_atcc	Flag for ATCC, ATCINT setting (C64x devices only). The following constants must be used: <input type="checkbox"/> 0 <input type="checkbox"/> EDMA_ATCC_SET or 1
parent	EDMA handle following the chainable transfer.								
nextChannel	EDMA handle associated with the channel to be chained.								
flag_tcc	Flag for TCC,TCINT setting (and TCCM for C64x devices). The following constants must be used: <input type="checkbox"/> 0 <input type="checkbox"/> EDMA_TCC_SET or 1								
flag_atcc	Flag for ATCC, ATCINT setting (C64x devices only). The following constants must be used: <input type="checkbox"/> 0 <input type="checkbox"/> EDMA_ATCC_SET or 1								
Return Value	none								
Description	<p>Sets the TCC,TCINT fields (and TCCM field for C64x devices) of the “parent” EDMA handle based on the “nextChannel” EDMA handle.</p> <p>For C621x/C671x, only channels from 8 to 11 are chainable.</p>								

Example

```

EDMA_Handle hEdmaChain, hEdmaPar;
Unit32 Tcc;

/*Open and Configure parent Channel*/
hEdmaPar=EDMA_open(EDMA_CHA_TINT1, EDMA_OPEN_RESET);
EDMA_config(hEdmaPar, &myConfig);

/*Allocate a transfer complete code*/
Tcc=intAlloc(-1);

/*Open the Channel for the next transfer with TCC value*/
hEdmaChain=EDMA_open(Tcc, EDMA_OPEN_RESET);

/*Update the TCC, TCINT, (TCCM) fields of the parent channel
configuration*/
EDMA_chain(hEdmaPar, hEdmaChain, EDMA_TCC_SET, 0)
/*Enable chaining: CCER (CCERL/CCERH) setting*/
);
EDMA_enableChaining(hEdmaChain);

```

EDMA_clearChannel *Clears EDMA event flag in EDMA channel event register***Function**

```

void EDMA_clearChannel(
    EDMA_Handle hEdma
);

```

Arguments

hEdma Device handle, see EDMA_open().

Return Value

none

Description

This function clears the EDMA event flag in the EDMA channel event register by writing to the appropriate bit in the EDMA event clear register (ECR).

This function accepts the following device handle:

From EDMA_open()

Example

```

EDMA_clearChannel(hEdma);

```

EDMA_clearPram

EDMA_clearPram *Clears the EDMA parameter RAM (PRAM)*

Function	<pre>void EDMA_clearPram(Uint32 val);</pre>
Arguments	val Value to clear the PRAM with
Return Value	none
Description	This function clears all of the EDMA parameter RAM with the value specified. This function should not be called if EDMA channels are active.
Example	<pre>EDMA_clearPram(0);</pre>

EDMA_disableChaining *Disables EDMA chaining*

Function	<pre>void EDMA_disableChaining(EDMA_Handle hEdma);</pre>
Arguments	hEdma EDMA handle to be chained
Return Value	none
Description	Disables the CCE bit in the Channel Chaining Enable Register associated with the EDMA handle. See also <code>EDMA_enableChaining()</code> . For C621x/C671x, only channels from 8 to 11 are chainable.
Example	<pre>EDMA_enableChaining(hEdmaCha8); EDMA_disableChaining(hEdmaCha8);</pre>

EDMA_enableChaining *Enables EDMA chaining*

Function	<pre>void EDMA_enableChaining(EDMA_Handle hEdma);</pre>
Arguments	hEdma EDMA handle to be chained
Return Value	none
Description	Enables the CCE bit in the Channel Chaining Enable Register associated with the EDMA handle.

For C621x/C671x, only channels from 8 to 11 are chainable.

Example

```
EDMA_Handle hEdmaCha8
Uint32 Tcc;

/*Allocate the transfer complete code*/
Tcc=EDMA_intAlloc(8);
/*Open the channel related to the TCC*/
hEdmaCha8=EDMA_open(Tcc,EDMA_OPEN_RESET);
/*Enable chaining*/
EDMA_enableChaining(hEdmaCha8);
```

EDMA_disableChannel *Disables EDMA channel***Function**

```
void EDMA_disableChannel(
    EDMA_Handle hEdma
);
```

Arguments

hEdma Device handle, see EDMA_open().

Return Value

none

Description

Disables an EDMA channel by clearing the corresponding bit in the EDMA event enable register. See also EDMA_enableChannel().

This function accepts the following device handle:

From EDMA_open()

Example

```
EDMA_disableChannel(hEdma);
```

EDMA_enableChannel *Enables EDMA channel***Function**

```
void EDMA_enableChannel(
    EDMA_Handle hEdma
);
```

Arguments

hEdma Device handle, see EDMA_open().

Return Value

none

Description

Enables an EDMA channel by setting the corresponding bit in the EDMA event enable register. See also EDMA_disableChannel(). When you open an EDMA channel it is disabled, so you must enable it explicitly.

EDMA_freeTable

This function accepts the following device handle:

From `EDMA_open()`

Example

```
EDMA_enableChannel(hEdma);
```

EDMA_freeTable *Frees up PRAM table previously allocated*

Function

```
void EDMA_freeTable(  
    EDMA_Handle hEdma  
);
```

Arguments

`hEdma` Device handle. See `EDMA_allocTable()`.

Return Value

none

Description

This function frees up a PRAM table previously allocated via `EDMA_allocTable()`.

This function accepts the following device handle:

From `EDMA_allocTable()`

Example

```
EDMA_freeTable(hEdmaTable);
```

EDMA_freeTableEx *Frees a previously allocated set of parameter RAM tables*

Function

```
void EDMA_freeTableEx(  
    int cnt,  
    EDMA_Handle *array  
);
```

Arguments

`cnt` Number of table handles in array to free

`array` An array containing table handles for each table to be freed

Return Value

none

Description

This function frees a set of parameter RAM tables that were previously allocated. You use PRAM tables for linking transfers together. The array that is passed in must contain the table handles for each one to be freed.

Example

```
EDMA_Handle hEdmaTableArray[16];  
...  
if (EDMA_allocTableEx(16, hEdmaTableArray)) {  
    ...  
}  
...  
EDMA_freeTableEx(16, hEdmaTableArray);
```

EDMA_getChannel *Returns current state of channel event*

Function	<pre> Uint32 EDMA_getChannel(EDMA_Handle hEdma); </pre>	
Arguments	hEdma	Device handle. See <code>EDMA_open()</code> .
Return Value	Channel Flag	Channel event flag: <input type="checkbox"/> 0 – event not detected <input type="checkbox"/> 1 – event detected
Description	Returns the current state of the channel event by reading the event flag from the EDMA channel event register (ER). This function accepts the following device handle: From <code>EDMA_open()</code>	
Example	<pre> flag = EDMA_getChannel(hEdma); </pre>	

EDMA_getConfig *Reads the current EDMA configuration values*

Function	<pre> void EDMA_getConfig(EDMA_Handle hEdma, EDMA_Config *config); </pre>	
Arguments	hEdma	Device handle. See <code>EDMA_open()</code> .
	config	Pointer to a configuration structure.
Return Value	none	
Description	Get EDMA current configuration value	
Example	<pre> EDMA_Config edmaCfg; EDMA_getConfig(hEdma, &edmaCfg); </pre>	

EDMA_getPriQStatus

EDMA_getPriQStatus *Returns value of priority queue status register (PQSR)*

Function	UInt32 EDMA_getPriQStatus();
Arguments	none
Return Value	Status Returns status of the priority queue
Description	Returns the value of the priority queue status register (PQSR). May be the logical OR of any of the following: <ul style="list-style-type: none"><input type="checkbox"/> 0x00000001– PQ0<input type="checkbox"/> 0x00000002– PQ1<input type="checkbox"/> 0x00000004 – PQ2
Example	<pre>pqStat = EDMA_getPriQStatus();</pre>

EDMA_getScratchAddr *Returns starting address of EDMA PRAM scratch area*

Function	UInt32 EDMA_getScratchAddr();
Arguments	none
Return Value	Scratch Address 32-bit starting address of PRAM scratch area
Description	There is a small portion of the EDMA PRAM that is not used for parameter tables and is free for use as non-cacheable on-chip SRAM. This function returns the starting address of this scratch area. See also EDMA_getScratchSize().
Example	<pre>UInt32 *scratchWord; scratchWord = (UInt32*)EDMA_getScratchAddr();</pre>

EDMA_getScratchSize *Returns size (in bytes) of EDMA PRAM scratch area*

Function	UInt32 EDMA_getScratchSize();
Arguments	none
Return Value	Scratch Size Size of PRAM scratch area in bytes
Description	There is a small portion of the EDMA PRAM that is not used for parameter tables and is free for use as non-cacheable on-chip SRAM. This function returns the size of this scratch area in bytes. See also EDMA_getScratchAddr().
Example	<pre>scratchSize = EDMA_getScratchSize();</pre>

EDMA_getTableAddress *Returns 32-bit absolute address of table*

Function	<pre> Uint32 EDMA_getTableAddress(EDMA_Handle hEdma); </pre>
Arguments	hEdma Device handle obtained by EDMA_allocTable().
Return Value	Table Address 32-bit address of table
Description	<p>Given a device handle obtained from EDMA_allocTable(), this function returns the 32-bit absolute address of the table.</p> <p>This function accepts the following device handle:</p> <p style="padding-left: 40px;">From EDMA_allocTable()</p>
Example	<pre> addr = EDMA_getTableAddress(hEdmaTable); </pre>

EDMA_intAlloc *Allocates a transfer complete code*

Function	<pre> int EDMA_intAlloc(int tcc); </pre>
Arguments	tcc Transfer-complete code number or -1
Return Value	tccReturn Transfer-complete code number or -1
Description	<p>This function allocates the transfer-complete code passed in and returns the same TCC number if successful, or -1 otherwise. If -1 is used as an argument, the first available TCC number is allocated.</p>
Example	<pre> EDMA_intAlloc(5); EDMA_intAlloc(43); tcc=EDMA_intAlloc(-1); </pre>

EDMA_intClear *Clears EDMA transfer-completion interrupt-pending flag*

Function	<pre> void EDMA_intClear(Uint32 intNum); </pre>
Arguments	intNum Transfer-completion interrupt number [0..31].

EDMA_intDefaultHandler

Return Value	none
Description	This function clears a transfer-completion interrupt flag by modifying the CIPR register appropriately. Note: If the DAT module is open [see <code>DAT_open()</code>], then EDMA transfer-completion interrupts 1 through 4 are reserved.
Example	<pre>EDMA_intClear(12);</pre>

EDMA_intDefaultHandler

Default function called by EDMA_intDispatcher()

Function	<pre>void EDMA_intDefaultHandler(int tccNum);</pre>
Arguments	tccNum Channel completion number
Return Value	none
Description	This is the default function that is called by <code>EDMA_intDispatcher()</code> . It does nothing, it just returns. See also <code>EDMA_intDispatcher()</code> and <code>EDMA_intHook()</code> .

EDMA_intDisable

Disables EDMA transfer-completion interrupt

Function	<pre>void EDMA_intDisable(Uint32 intNum);</pre>
Arguments	intNum Transfer-completion interrupt number [0..31].
Return Value	none
Description	This function disables a transfer-completion interrupt by modifying the CIER register appropriately. Note: If the DAT module is open [see <code>DAT_open()</code>], then EDMA transfer-completion interrupts 1 through 4 are reserved.
Example	<pre>EDMA_intDisable(12);</pre>

EDMA_intDispatcher

Calls an ISR when CIER[x] and CIPR[x] are both set

Function	<pre>void EDMA_intDispatcher(void);</pre>
Arguments	none

Return Value	none
Description	This function checks for CIER and CIPR for all those bits which are set in both the registers and calls the corresponding ISR. For example, if CIER[14] = 1 and CIPR[14] = 1 then it calls the ISR corresponding to channel 14. By default, this ISR is <code>EDMA_intHandler()</code> , however, this can be changed by <code>EDMA_intHook()</code> . See also <code>EDMA_intDefaultHandler()</code> and <code>EDMA_intHook()</code> .
Example	<code>EDMA_intDispatcher();</code>

EDMA_intEnable *Enables the EDMA transfer-completion interrupt*

Function	<code>void EDMA_intEnable(Uint32 intNum);</code>
Arguments	<code>intNum</code> Transfer-completion interrupt number [0..31].
Return Value	none
Description	This function enables a transfer completion interrupt by modifying the CIER register appropriately. Note: If the DAT module is open [see <code>DAT_open()</code>], then EDMA transfer-completion interrupts 1 through 4 are reserved.
Example	<code>EDMA_intEnable(12);</code>

EDMA_intFree *Frees the transfer-complete code number*

Function	<code>void EDMA_intFree(int tcc);</code>
Arguments	<code>tcc</code> Transfer-complete code number to be free
Return Value	none
Description	This function frees a transfer-complete code number previously allocated.
Example	<code>EDMA_intAlloc(17); ... EDMA_intFree(17);</code>

EDMA_intHook

EDMA_intHook *Hooks an isr to a channel, which is called by EDMA_intDsipatcher()*

Function EDMA_IntHandler EDMA_intHook(
int tccNum
EDMA_IntHandler funcAddr
);

Arguments tccNum Channel to which the ISR is to be hooked

funcAddr ISR name

Return Value IntHandler Returns the old ISR address

Description This function hooks an ISR to the specified channel.

When the tcint is '1' and tccNum is specified in the EDMA options, the EDMA controller sets the corresponding bit in the CIPR register. If the corresponding bit in the CIER register is also set, then calling `EDMA_intDispatcher()` would call the ISR corresponding the the tccNum, which by default is nothing. To change this default ISR to a different one, use `EDMA_intHook()`. Only when an ISR is hooked this way would it be called. See also `EDMA_intDefaultHandler()` and `EDMA_intDispatcher()`.

Example

```
void complete();  
EDMA_intHook(13, complete); //Hooks complete function to  
channel 13
```

EDMA_intReset *Resets a specified interrupt*

Function void EDMA_intReset(
uint32_t tccIntNum
);

Arguments tccIntNum Interrupt mask of interrupt to be reset

Return Value None

Description A single interrupt can be turned off using this function. This function turns off the corresponding bit for the interrupt number in the CIERL or CIERH in case of C64xx devices and int the CIER in case of others.

Example

```
EDMA_intReset(0x1);  
//turn off interrupt related to bit 1 of CIER (or CIERL in  
case of C64xx devices)
```

EDMA_intResetAll *Resets all interrupts for the device*

Function	void EDMA_intResetAll();
Arguments	None
Return Value	None
Description	This function resets the CIER register (CIERL and CIERH in case of C64xx devices) so that all interrupts are disabled. It also sets all the bits of the CIPR register (CIPRL and CIPRH in case of C64xx devices).

EDMA_intTest *Tests EDMA transfer-completion interrupt-pending flag*

Function	Uint32 EDMA_intTest(Uint32 intNum);
Arguments	intNum Transfer-completion interrupt number [0..31].
Return Value	Uint32 Result: 0 = flag was clear 1 = flag was set
Description	This function tests a transfer-completion interrupt flag by reading the CIPR register appropriately. Note: If the DAT module is open [see DAT_open()], then EDMA transfer-completion interrupts 1 through 4 are reserved.
Example	<pre>if (EDMA_intTest(12)) { ... }</pre>

EDMA_link *Links two EDMA transfers together*

Function	void EDMA_link(EDMA_Handle parent, EDMA_Handle child);
Arguments	parent Handle of the parent (link from parent) child Handle of the child (link to child)

EDMA_map

Return Value	none
Description	<p>This function links two EDMA transfers together by setting the LINK field of the parent's RLD parameter appropriately. Both parent and child handles may be from <code>EDMA_open()</code>, <code>EDMA_allocTable()</code>, or a combination of both.</p> <p>parent->child</p> <p>Note: This function does not attempt to set the LINK field of the OPT parameter; this is still up to the user.</p>
Example	<pre>EDMA_Handle hEdma; EDMA_Handle hEdmaTable; ... hEdma = EDMA_open(EDMA_CHA_TINT1, 0); hEdmaTable = EDMA_allocTable(-1); EDMA_link(hEdma, hEdmaTable); EDMA_link(hEdmaTable, hEdmaTable);</pre>

EDMA_map

Maps EDMA event to a channel

Function	<code>void EDMA_map(</code> <code>int eventNum,</code> <code>int chNum</code>
Arguments	<code>eventNum</code> EDMA event to be mapped to channel <code>chNum</code> Channel to which event is to be mapped
Return Value	<code>int</code> Returns channel selected for mapping
Description	This function maps the given EDMA event to specified channel
Example	<code>EDMA_map(12, 3); //Maps event 12 to channel 3</code>

EDMA_qdmaConfig

Sets up QDMA registers using configuration structure

Function	<code>void EDMA_qdmaConfig(</code> <code>EDMA_Config *config</code> <code>);</code>
Arguments	<code>config</code> Pointer to an initialized configuration structure
Return Value	none
Description	Sets up the QDMA registers using the configuration structure. The <code>src</code> , <code>cnt</code> , <code>dst</code> , and <code>idx</code> values are written to the normal QDMA registers, then the <code>opt</code> value is written to the pseudo-OPT register which initiates the transfer. The <code>rlid</code> member of the structure is ignored, since the QDMA does not support reloads or linking. See also <code>EDMA_qdmaConfigArgs()</code> and <code>EDMA_Config</code> .

```

Example      EDMA_Config myConfig = {
                0x41200000, /* opt */
                0x80000000, /* src */
                0x00000040, /* cnt */
                0x80010000, /* dst */
                0x00000004, /* idx */
                0x00000000 /* rld will be ignored */
                };
                ...
                EDMA_qdmaConfig(&myConfig);

```

EDMA_qdmaConfigArgs *Sets up QDMA registers using arguments*

Function	void EDMA_qdmaConfigArgs(Uint32 opt, Uint32 src, Uint32 cnt, Uint32 dst, Uint32 idx);
Arguments	opt Options src Source address cnt Transfer count dst Destination address idx Index
Return Value	none
Description	Sets up the QDMA registers using the arguments passed in. The src, cnt, dst, and idx values are written to the normal QDMA registers, then the opt value is written to the pseudo-OPT register which initiates the transfer. See also EDMA_qdmaConfig() and EDMA_Config.
Example	EDMA_qdmaConfigArgs(0x41200000, /* opt */ 0x80000000, /* src */ 0x00000040, /* cnt */ 0x80010000, /* dst */ 0x00000004 /* idx */);

EDMA_resetAll

EDMA_resetAll *Resets all EDMA channels supported by the chip device*

Function	void EDMA_resetAll();
Arguments	none
Return Value	none
Description	This function resets all EDMA channels supported by the device by disabling EDMA enable bits, disabling and clearing the channel interrupt registers, and clearing the PRAM tables associated to the EDMA events.
Example	<pre>EDMA_resetAll();</pre>

EDMA_resetPriQLength *Resets the priority queue length (C64x devices only)*

Function	void EDMA_resetPriQLength(uint32 priNum)
Arguments	priNum Queue Number [0–3] associated to the following constants: <input type="checkbox"/> EDMA_Q0 <input type="checkbox"/> EDMA_Q1 <input type="checkbox"/> EDMA_Q2 <input type="checkbox"/> EDMA_Q3
Return Value	none
Description	Resets the queue length of the associated priority queue allocation register to the default value. See also EDMA_setPriQLength() function
Example	<pre>/* Sets the queue length of the PQAR0 register */ EDMA_setPriQLength(EDMA_Q0,4); /* Resets the queue length of the PQAR0 */ EDMA_resetPriQLength(EDMA_Q0);</pre>

EDMA_setChannel *Triggers EDMA channel by writing to appropriate bit in ESR*

Function	void EDMA_setChannel(EDMA_Handle hEdma)
Arguments	hEdma Device handle obtained by EDMA_open().

Return Value	none
Description	Software triggers an EDMA channel by writing to the appropriate bit in the EDMA event set register (ESR). This function accepts the following device handle: From <code>EDMA_open()</code>
Example	<code>EDMA_setChannel(hEdma);</code>

EDMA_setEvtPolarity *Sets the event polarity associated with an EDMA channel*

Function	<pre>void EDMA_setEvtPolarity(EDMA_handle hEdma, int polarity);</pre>	
Arguments	hEdma	Device handle associated with the EDMA channel obtained by <code>EDMA_open()</code>
	polarity	Event polarity (0 or 1) <input type="checkbox"/> <code>EDMA_EVT_LOWHIGH</code> (0) <input type="checkbox"/> <code>EDMA_EVT_HIGHLOW</code> (1)
Return Value	none	
Description	Sets the polarity of the event associated with the EDMA channel.	
Example	<pre>/* Sets the polarity of the event to falling-edge of transition*/ hEdma=EDMA_open(EDMA_CHA_TINT1, 0); EDMA_setEvtPolarity(hEdma, EDMA_EVT_HIGHLOW);</pre>	

EDMA_setPriQLength *Sets the priority queue length (C64x devices only)*

Function	<pre>EDMA_setPriQLength(Uint32 priNum, Uint32 length);</pre>	
Arguments	priNum	Queue Number [0–3] associated to the following constants: <input type="checkbox"/> <code>EDMA_Q0</code> <input type="checkbox"/> <code>EDMA_Q1</code> <input type="checkbox"/> <code>EDMA_Q2</code> <input type="checkbox"/> <code>EDMA_Q3</code>
	length	length of the queue

EDMA_SUPPORT

Return Value	none
Description	Sets the queue length of the associated priority queue allocation register (See <code>EDMA_resetPriQLength()</code> function.)
Example	<pre>/* Sets the queue length of the PQAR1 register to 4 */ EDMA_setPriQLength(EDMA_Q1,4); EDMA_resetPriQLength(EDMA_Q1);</pre>

EDMA_SUPPORT *Compile-time constant*

Constant	EDMA_SUPPORT
Description	<p>Compile-time constant that has a value of 1 if the device supports the EDMA module and 0 otherwise. You are not required to use this constant.</p> <p>Note: The EDMA module is not supported on devices that do not have the EDMA peripheral. In these cases, the DMA module is supported instead.</p>
Example	<pre>#if (EDMA_SUPPORT) /* user EDMA configuration / #elif (DMA_SUPPORT) / user DMA configuration */ #endif</pre>

EDMA_TABLE_CNT *Compile-time constant*

Constant	EDMA_TABLE_CNT
Description	Compile-time constant that holds the total number of reload/link parameter-table entries in the EDMA PRAM.

EMAC Module

This chapter describes the EMAC module, lists the API functions and macros within the module, and provides an EMAC reference section.

Topic	Page
8.1 Overview	8-2
8.2 Macros	8-4
8.3 Configuration Structure	8-6
8.4 Functions	8-13

8.1 Overview

The ethernet media access controller (EMAC) module provides an efficient interface between the DSP core processor and the networked community. The EMAC supports both 10Base-T (10Mbps/sec) and 100BaseTX (100Mbps/sec), in either half or full duplex, with hardware flow control and quality-of-service (QOS) support.

Note: When used in a multitasking environment, no EMAC function may be called while another EMAC function is operating on the same device handle in another thread. It is the responsibility of the application to assure adherence to this restriction.

Table 8–1 lists the configuration structures for use with the EMAC functions.

Table 8–2 lists the functions and constants available in the CSL EMAC module.

Table 8–1. EMAC Configuration Structure

Structure	Purpose	See page
EMAC_Config	The config structure defines how the EMAC device should operate	8-6
EMAC_Pkt	The packet structure defines the basic unit of memory used to hold data packets for the EMAC device	8-8
EMAC_Status	The status structure contains information about the MAC's run-time status	8-10
EMAC_Statistics	The statistics structure is used to retrieve the current count of various packet events in the system	8-11

Table 8–2. EMAC APIs

Syntax	Type	Description	See page
EMAC_close	F	Closes the EMAC peripheral indicated by the supplied instance handle	8-13
EMAC_enumerate	F	Enumerates the EMAC peripherals installed in the system and returns an integer count	8-13
EMAC_getReceiveFilter	F	Called to get the current packet filter setting for received packets.	8-14
EMAC_getStatistics	F	Called to get the current device statistics	8-15
EMAC_getStatus	F	Called to get the current device status	8-16
EMAC_open	F	Opens the EMAC peripheral at the given physical index	8-17
EMAC_setReceiveFilter	F	Called to set the packet filter for received packets	8-18

Table 8–2. EMAC APIs (Continued)

Syntax	Type	Description	See page
EMAC_setMulticast	F	Called to install a list of multicast addresses for use in multicast address filtering	8-19
EMAC_sendPacket	F	Sends a Ethernet data packet out the EMAC device	8-20
EMAC_serviceCheck	F	This function should be called every time there is an EMAC device interrupt	8-21
EMAC_SUPPORT	C	A compile-time constant whose value is 1 if the device supports the EMAC module	8-22
EMAC_timerTick	F	This function should be called for each device in the system on a periodic basis of 100 mS	8-22

8.2 Macros

There are two types of EMAC macros: those that access registers and fields, and those that construct register and field values. Table 8–3 lists the EMAC macros that access registers and fields, and Table 8–3 lists the EMAC macros that construct register and field values. The macros themselves are found in Chapter 28, *Using the HAL Macros*.

Table 8–3. EMAC Macros That Access Registers and Fields

Macro	Description/Purpose	See page
EMAC_ADDR(<REG>)	Register address	28-12
EMAC_RGET(<REG>)	Returns the value in the peripheral register	28-18
EMAC_RGETI(<REGBASE>,<IDX>)	Returns the value of register at position IDX from REGBASE	
EMAC_RSET(<REG>,x)	Register set	28-20
EMAC_RSETI(<REGBASE>,<IDX>,x)	Sets the value of register at position IDX from REGBASE	
EMAC_FGET(<REG>,<FIELD>)	Returns the value of the specified field in the peripheral register	28-13
EMAC_FGETI(<REGBASE>,<IDX>,<FIELD>)	Returns the value of field of register at position IDX from REGBASE	
EMAC_FSET(<REG>,<FIELD>,fieldval)	Writes fieldval to the specified field in the peripheral register	28-15
EMAC_FSETI(<REGBASE>,<IDX>,<FIELD>,x)	Sets the value of field of register at position IDX from REGBASE	
EMAC_FSETS(<REG>,<FIELD>,<SYM>)	Writes the symbol value to the specified field in the peripheral	28-17
EMAC_FSETSI(<REGBASE>,<IDX>,<FIELD>,<SYM>)	Writes the symbol value to field of register at position IDX from REGBASE	

Table 8–4. EMAC Macros that Construct Registers and Fields

Macro	Description/Purpose	See page
EMAC_<REG>_DEFAULT	Register default value	28-21
EMAC_<REG>_RMK()	Register make	28-23
EMAC_<REG>_OF()	Register value of	28-22
EMAC_<REG>_<FIELD>_DEFAULT	Field default value	28-24
EMAC_FMK()	Field make	28-14
EMAC_FMKS()	Field make symbolically	28-15
EMAC_<REG>_<FIELD>_OF()	Field value of	28-24
EMAC_<REG>_<FIELD>_<SYM>	Field symbolic value	28-24

8.3 Configuration Structure

EMAC_Config *EMAC configuration defines how the EMAC device should operate*

Members

```
Uint ModeFlags:           /* Configuration Mode Flags */

Uint MdioModeFlags;      /* csl_mdio Mode Flags (see csl_mdio.h) */

Uint TxChannels;        /* Number of Tx Channels to use (1-8) */

Uint8 MacAddr[6];       /* Mac Address */

Uint RxMaxPktPool;      /* Max Rx packet buffers to get from pool */

EMAC_Pkt EMAC_Pkt * (*pfcBGetPacket)(Handle hApplication);
                        /* Callback function */
void (*pfcBFreePacket)(Handle hApplication, EMAC_Pkt *pPacket);
                        /* Callback function */
EMAC_Pkt * (*pfcBRxPacket)(Handle hApplication, EMAC_Pkt *pPacket);
                        /* Callback function */
void (*pfcBStatus)(Handle hApplication);
                        /* Callback function */
void (*pfcBStatistics)(Handle hApplication);
                        /* Callback function */
```

Description The config structure defines how the EMAC device should operate. It is passed to the device when the device is opened, and remains in effect until the device is closed.

A list of callback functions is used to register callback functions with a particular instance of the EMAC peripheral. Callback functions are used by EMAC to communicate with the application. These functions are REQUIRED for operation. The same callback table can be used for multiple driver instances.

The callback functions can be used by EMAC during any EMAC function, but mostly occur during calls to EMAC_statusIsr() and EMAC_statusPoll().

* pfcBGetPacket

Called by EMAC to get a free packet buffer from the application layer for receive data. This function should return NULL if no free packets are available. The size of the packet buffer must be large enough to accommodate a full sized packet (1514 or 1518 depending on the EMAC_CONFIG_MODEFLG_RXCRC flag), plus any application buffer padding (DataOffset).

* pfcBFreePacket

Called by EMAC to give a free packet buffer back to the application layer. This function is used to return transmit packets. Note that at the time of the call, structure fields other than pDataBuffer and BufferLen are in an undefined state.

* pfcBRxPacket

Called to give a received data packet to the application layer. The application must accept the packet. When the application is finished with the packet, it can return it to its own free queue. This function also returns a pointer to a free packet to replace the received packet on the EMAC free list. It returns NULL when no free packets are available. The return packet is the same as would be returned by pfcBGetPacket. Therefore, if a newly received packet is not desired, it can simply be returned to EMAC via the return value.

* pfcBStatus

Called to indicate to the application that it should call EMAC_getStatus() to read the current device status. This call is made when device status changes.

* pfcBStatistics

Called to indicate to the application that it should call EMAC_getStatistics() to read the current Ethernet statistics. Called when the statistic counters are to the point of overflow. The hApplication calling argument is the application's handle as supplied to the EMAC device in the EMAC_open() function.

EMAC_Pkt

EMAC_Pkt

Defines the basic unit of memory used to hold data packets for the EMAC

Members

```
UInt32 AppPrivate;           /*For use by the application
struct _EMAC_Pkt *pPrev;    /*Previous record */
struct _EMAC_Pkt *pNext;    /*Next record */
UInt8 *pDataBuffer;         /*Pointer to Data Buffer (read only) */
UInt32 BufferLen;           /*Physical Length of buffer (read only) */
UInt32 Flags;               /*Packet Flags */
UInt32 ValidLen;           /*Length of valid data in buffer */
UInt32 DataOffset;         /*Byte offset to valid data */
UInt32 PktChannel;         /*Tx/Rx Channel/Priority 0-7 (SOP only) */
UInt32 PktLength;          /*Length of Packet (SOP only) */
                             /*(same as ValidLen on single frag Pkt) */
UInt32 PktFrag;            /*Number of frags in packet (SOP only) */
                             /*(frag is EMAC_Pkt record - normally 1)*/
```

Description

The packet structure defines the basic unit of memory used to hold data packets for the EMAC device.

A packet is comprised of one or more packet buffers. Each packet buffer contains a packet buffer header, and a pointer to the buffer data. The EMAC_Pkt structure defines the packet buffer header.

The pDataBuffer field points to the packet data. This is set when the buffer is allocated, and is not altered.

BufferLen holds the the total length of the data buffer that is used to store the packet (or packet fragment). This size is set by the entity that originally allocates the buffer, and is not altered.

The Flags field contains additional information about the packet.

ValidLen holds the length of the valid data currently contained in the data buffer.

DataOffset is the byte offset from the start of the data buffer to the first byte of valid data. Therefore, (ValidLen+DataOffset)<=BufferLen.

Note that for receive buffer packets, the DataOffset field may be assigned before there is any valid data in the packet buffer. This allows the application to reserve space at the top of data buffer for private use. In all instances, the

DataOffset field must be valid for all packets handled by EMAC.

The data portion of the packet buffer represents a packet or a fragment of a larger packet. This is determined by the Flags parameter. At the start of every packet, the SOP bit is set in Flags. If the EOP bit is also set, then the packet is not fragmented. Otherwise; the next packet structure pointed to by the pNext field will contain the next fragment in the packet. On either type of buffer, when the SOP bit is set in Flags, then the PktChannel, PktLength, and PktFrag fields must also be valid. These fields contain additional information about the packet.

The PktChannel field determines what channel the packet has arrived on, or what channel it should be transmitted on. The EMAC library supports only a single receive channel, but allows for up to eight transmit channels. Transmit channels can be treated as round-robin or priority queues.

The PktLength field holds the size of the entire packet. On single frag packets (both SOP and EOP set in BufFlags), PktLength and ValidLen will be equal. The PktFrag field holds the number of fragments (EMAC_Pkt records) used to describe the packet. If more than 1 frag is present, the first record must have EMAC_PKT_FLAGS_SOP flag set, with corresponding fields validated. Each frag/record must be linked list using the pNext field, and the final frag/record must have EMAC_PKT_FLAGS_EOP flag set and pNext=0.

In systems where the packet resides in cacheable memory, the data buffer must start on a cache line boundary and be an even multiple of cache lines in size. The EMAC_Pkt header must not appear in the same cache line as the data portion of the packet. On multi-fragment packets, some packet fragments may reside in cacheable memory where others do not.

Note: It is up to the caller to assure that all packet buffers residing in cacheable memory are not currently stored in L1 or L2 cache when passed to any EMAC function.

Some of the packet Flags can only be set if the device is in the proper configuration to receive the corresponding frames. In order to enable these flags, the following modes must be set:

- RxCrc Flag : RXCRC Mode in EMAC_Config
- RxErr Flags : PASSERROR Mode in EMAC_Config
- RxCtl Flags : PASSCONTROL Mode in EMAC_Config
- RxPrm Flag : EMAC_RXFILTER_ALL in EMAC_setReceiveFilter()

EMAC_Status

EMAC_Status

Contains Information about the MAC's run-time status

Members	uint dioLinkStatus;	/* csl_mdio Link status (see csl_mdio.h) */
	uint PhyDev;	/* Current PHY device in use (0-31) */
	uint RxPktHeld;	/* Number of packets held for Rx */
	uint TxPktHeld;	/* Number of packets held for Tx */
	uint FatalError;	/* Fatal Error when non-zero */

Description The status structure contains information about the MAC's run-time status. The following is a short description of the configuration fields:

- MdioLinkStatus
Current link status (non-zero on link) (see csl_mdio.h)
- PhyDev
Current PHY device in use (0-31)
- RxPktHeld
Current number of Rx packets held by the EMAC device
- TxPktHeld
Current number of Tx packets held by the EMAC device
- FatalError
Fatal Error Code

EMAC_Statistics*Retrieves the current count of various packet events in the system***Members**

```

Uint32 RxGoodFrames;      /* Good Frames Received */
Uint32 RxBCastFrames;     /* Good Broadcast Frames Received */
Uint32 RxMCastFrames;     /* Good Multicast Frames Received */
Uint32 RxPauseFrames;     /* PauseRx Frames Received */
Uint32 RxCRCErrors;       /* Frames Received with CRC Errors */
Uint32 RxAlignCodeErrors; /* Frames Received with Alignment/Code
                          Errors */

Uint32 RxOversized;       /* Oversized Frames Received */
Uint32 RxJabber;          /* Jabber Frames Received */
Uint32 RxUndersized;      /* Undersized Frames Received */
Uint32 RxFragments;       /* Rx Frame Fragments Received */
Uint32 RxFiltered;        /* Rx Frames Filtered Based on Address */
Uint32 RxQOSFiltered;     /* Rx Frames Filtered Based on QoS
                          Filtering */

Uint32 RxOctets;          /* Total Received Bytes in Good Frames */
Uint32 TxGoodFrames;      /* Good Frames Sent */
Uint32 TxBCastFrames;     /* Good Broadcast Frames Sent */
Uint32 TxMCastFrames;     /* Good Multicast Frames Sent */
Uint32 TxPauseFrames;     /* PauseTx Frames Sent */
Uint32 TxDeferred;        /* Frames Where Transmission was
                          Deferred */

Uint32 TxCollision;       /* Total Frames Sent With Collision */
Uint32 TxSingleColl;      /* Frames Sent with Exactly One Collision*/
Uint32 TxMultiColl;       /* Frames Sent with Multiple Colisions */
Uint32 TxExcessiveColl;   /* Tx Frames Lost Due to Excessive
                          Collisions */

Uint32 TxLateColl;        /* Tx Frames Lost Due to a Late Collision*/
Uint32 TxUnderrun;        /* Tx Frames Lost with Transmit Underrun
                          Error */

Uint32 TxCarrierSLoss;    /* Tx Frames Lost Due to Carrier Sense
                          Loss */

Uint32 TxOctets;          /* Total Transmitted Bytes in Good
                          Frames*/

Uint32 Frame64;           /* Total Tx&Rx with Octet Size of 64 */
Uint32 Frame65t127;       /* Total Tx&Rx with Octet Size of 65 to
                          127 */

Uint32 Frame128t255;      /* Total Tx&Rx with Octet Size of 128 to

```

EMAC_Statistics

Uin32 Frame256t511;	255 */ /* Total Tx&Rx with Octet Size of 256 to 511 */
Uin32 Frame512t1023;	/* Total Tx&Rx with Octet Size of 512 to 1023 */
Uin32 Frame1024tUp;	/* Total Tx&Rx with Octet Size of >=1024 */
Uin32 NetOctets;	/* Sum of all Octets Tx or Rx on the Network */
Uin32 RxSOFOverruns;	/* Total Rx Start of Frame Overruns */
Uin32 RxMOFOverruns;	/* Total Rx Middle of Frame Overruns */
Uin32 RxDMAOverruns;	/* Total Rx DMA Overruns */

Description

The statistics structure is the used to retrieve the current count of various packet events in the system. These values represent the delta values from the last time the statistics were read.

Note: The application is charged with verifying that only one of the following API calls may only be executing at a given time across all threads and all interrupt functions.

8.4 Functions

In the function descriptions, uint is defined as unsigned int and Handle as void*

EMAC_close *Closes the EMAC peripheral indicated by the supplied instance handle*

Function uint EMAC_close(
 Handle hEMAC
);

Arguments Handle hEMAC

Return Value uint

Description When called, the EMAC device will shutdown both send and receive operations, and free all pending transmit and receive packets. See EMAC_open for more details.

The function returns zero on success, or an error code on failure.

Possible error codes include:

EMAC_ERROR_INVALID – A calling parameter is invalid

Example

```
Handle hEMAC;
uint retStat;
...
retStat = EMAC_close(hEMAC);
```

EMAC_enumerate *Enumerates the peripherals installed in the system and returns an integer count*

Function uint EMAC_enumerate();

Arguments None

Return Value uint

Description Enumerates the EMAC peripherals installed in the system and returns an integer count. The EMAC devices are enumerated in a consistent fashion so that each device can be later referenced by its physical index value ranging from "1" to "n" where "n" is the count returned by this function.

Example

```
uint numOfEmac;
...
numOfEmac = EMAC_enumerate();
```

EMAC_getReceiveFilter

EMAC_getReceiveFilter *Called to get the current packet filter setting for received packets*

Function	uint EMAC_getReceiveFilter(Handle hEMAC, uint *pReceiveFilter);
Arguments	Handle hEMAC uint *pReceiveFilter
Return Value	uint
Description	<p>Called to get the current packet filter setting for received packets. The filter values are the same as those used in EMAC_setReceiveFilter(). The current filter value is written to the pointer supplied in pReceiveFilter. The function returns zero on success, or an error code on failure.</p> <p>Possible error code include: EMAC_ERROR_INVALID – A calling parameter is invalid</p>
Example	<pre>Handle hEMAC; uint *pReceiveFilter; uint retStat; ... retStat = EMAC_getReceiveFilter(hEMAC, pReceiveFilter);</pre>

EMAC_getStatistics *Called to get the current device statistics*

Function	<pre>uint EMAC_getStatistics(Handle hEMAC, EMAC_Statistics *pStatistics);</pre>
Arguments	Handle hEMAC EMAC_Statistics *pStatistics
Return Value	uint
Description	<p>Called to get the current device statistics. The statistics structure contains a collection of event counts for various packet sent and receive properties. Reading the statistics also clears the current statistic counters, so the values read represent a delta from the last call. The statistics information is copied into the structure pointed to by the pStatistics argument. The function returns zero on success, or an error code on failure.</p> <p>Possible error code include: EMAC_ERROR_INVALID – A calling parameter is invalid</p>
Example	<pre>uint retVal; Handle hEMAC; EMAC_Statistics *pStatistics; ... retVal = EMAC_getStatistics(hEMAC, pStatistics);</pre>

EMAC_getStatus

EMAC_getStatus *Called to get the current device status*

Function	<pre>uint EMAC_getStatus(Handle hEMAC, EMAC_Status *pStatus);</pre>
Arguments	Handle hEMAC EMAC_Status *pStatus
Return Value	uint
Description	<p>Called to get the current status of the device. The device status is copied into the supplied data structure. The function returns zero on success, or an error code on failure.</p> <p>Possible error code include: EMAC_ERROR_INVALID – A calling parameter is invalid</p>
Example	<pre>uint retVal; Handle hEMAC; EMAC_Status *pStatus; ... retVal = EMAC_getStatus(hEMAC, pStatus);</pre>

EMAC_open*Opens the EMAC peripheral at the given physical index*

Function	<pre>uint EMAC_open(int physicalIndex, Handle hApplication, EMAC_Config *pEMACConfig, Handle *phEMAC);</pre>
Arguments	<pre>int physicalIndex Handle hApplication EMAC_Config *pEMACConfig Handle *phEMAC</pre>
Return Value	uint
Description	<p>Opens the EMAC peripheral at the given physical index and initializes it to an embryonic state. The calling application must supply a operating configuration that includes a callback function table. Data from this config structure is copied into the device's internal instance structure so the structure may be discarded after EMAC_open() returns. In order to change an item in the configuration, the the EMAC device must be closed and then re-opened with the new configuration. The application layer may pass in an hApplication callback handle, that will be supplied by the EMAC device when making calls to the application callback functions. An EMAC device handle is written to phEMAC. This handle must be saved by the caller and then passed to other EMAC device functions.</p> <p>The default receive filter prevents normal packets from being received until the receive filter is specified by calling EMAC_receiveFilter(). A device reset is achieved by calling EMAC_close() followed by EMAC_open(). The function returns zero on success, or an error code on failure.</p> <p>Possible error codes include: EMAC_ERROR_ALREADY – The device is already open EMAC_ERROR_INVALID – A calling parameter is invalid</p>
Example	<pre>uint retVal; Handle hApplication; EMAC_Config *pEMACConfig; Handle *phEMAC; ... retVal = EMAC_open(1, hApplication, pEMACConfig, phEMAC);</pre>

EMAC_setReceiveFilter

EMAC_setReceiveFilter *Called to set the packet filter for received packets*

Function	uint EMAC_setReceiveFilter(Handle hEMAC, uint ReceiveFilter);
Arguments	Handle hEMAC uint ReceiveFilter
Return Value	uint
Description	Called to set the packet filter for received packets. The filtering level is inclusive, so BROADCAST would include both BROADCAST and DIRECTED (UNICAST) packets.

Available filtering modes include the following:

EMAC_RXFILTER_NOTHING – Receive nothing

EMAC_RXFILTER_DIRECT – Receive only Unicast to local MAC addr

EMAC_RXFILTER_BROADCAST – Receive direct and broadcast

EMAC_RXFILTER_MULTICAST – Receive above plus multicast in mcast list

EMAC_RXFILTER_ALLMULTICAST – Receive above plus all multicast

EMAC_RXFILTER_ALL – Receive all packets

Note that if error frames and control frames are desired, reception of these must be specified in the device configuration.

Possible error code include:

EMAC_ERROR_INVALID – A calling parameter is invalid

Example

```
uint retVal;  
Handle hEMAC;  
...  
retVal = EMAC_setReceiveFilter(hEMAC, EMAC_RXFILTER_DIRECT);
```

EMAC_setMulticast *Called to install a list of multicast addresses for use in multicast address filtering*

Function	<pre>uint EMAC_setMulticast(Handle hEMAC, uint AddrCnt, Uint8 *pMCastList);</pre>
Arguments	Handle hEMAC uint AddrCnt Uint8 *pMCastList
Return Value	uint
Description	<p>This function is called to install a list of multicast addresses for use in multicast address filtering. Each time this function is called, any current multicast configuration is discarded in favor of the new list. Therefore, a set with a list size of zero removes all multicast addresses from the device.</p> <p>Note that the multicast list configuration is stateless in that the list of multicast addresses used to build the configuration is not retained. Therefore, it is impossible to examine a list of currently installed addresses.</p> <p>The addresses to install are pointed to by pMCastList. The length of this list in bytes is 6 times the value of AddrCnt. When AddrCnt is zero, the pMCastList parameter can be NULL.. The function returns zero on success, or an error code on failure. The multicast list settings are not altered in the event of a failure code.</p> <p>Possible error code include: EMAC_ERROR_INVALID – A calling parameter is invalid</p>

Example

```
uint retVal;
Handle hEMAC;
Uint8 *pMCastList;
...
retVal = EMAC_setMulticast(hEMAC, 0, NULL);
```

EMAC_sendPacket

EMAC_sendPacket *Sends a Ethernet data packet out the EMAC device*

Function	<pre>uint EMAC_sendPacket(Handle hEMAC, EMAC_Pkt *pPacket);</pre>
Arguments	Handle hEMAC EMAC_Pkt *pPacket
Return Value	uint
Description	<p>Sends a Ethernet data packet out the EMAC device. On a non-error return, the EMAC device takes ownership of the packet. The packet is returned to the application's free pool once it has been transmitted.</p> <p>The function returns zero on success, or an error code on failure. When an error code is returned, the EMAC device has not taken ownership of the packet.</p> <p>Possible error codes include: EMAC_ERROR_INVALID – A calling parameter is invalid EMAC_ERROR_BADPACKET – The packet structure is invalid</p>
Example	<pre>uint retVal; Handle hEMAC; EMAC_Pkt *pPacket; ... retVal = EMAC_sendPacket(hEMAC, pPacket);</pre>

EMAC_serviceCheck *Called every time there is an EMAC device interrupt*

Function uint EMAC_serviceCheck(
 Handle hEMAC
);

Arguments Handle hEMAC

Return Value uint

Description This function should be called every time there is an EMAC device interrupt.
 It maintains the status the EMAC.

Note that the application has the responsibility for mapping the physical device index to the correct EMAC_serviceCheck() function. If more than one EMAC device is on the same interrupt, the function must be called for each device.

Possible error codes include:
EMAC_ERROR_INVALID – A calling parameter is invalid
EMAC_ERROR_MACFATAL – Fatal error in the MAC – Call EMAC_close()

Example

```
uint retVal;  
Handle hEMAC;  
...  
retVal = EMAC_serviceCheck(hEMAC);
```

EMAC_SUPPORT

EMAC_SUPPORT *Compile-time constant*

Description Compile-time constant that has a value of 1 if the device supports the EMAC module and 0 otherwise. You are not required to use this constant.

EMAC_timerTICK *Called for each device in the system on a periodic basis of 100 ms*

Function `uint EMAC_timerTick(
Handle hEMAC
);`

Arguments Handle hEMAC

Return Value uint

Description This function should be called for each device in the system on a periodic basis of 100 mS (10 times a second). It is used to check the status of the EMAC and MDIO device, and to potentially recover from low Rx buffer conditions. Strict timing is not required, but the application should make a reasonable attempt to adhere to the 100 mS mark. A missed call should not be "made up" by making multiple sequential calls. A "polling" driver (one that calls EMAC_serviceCheck() in a tight loop), must also adhere to the 100 mS timing on this function.

Possible error codes include:

EMAC_ERROR_INVALID – A calling parameter is invalid

Example

```
uint retVal;  
Handle hEMAC;  
retVal = EMAC_timerTick(hEMAC);
```

EMIF Module

This chapter describes the EMIF module, lists the API functions and macros within the module, and provides an EMIF API reference section.

Note: This module has not been updated for C64x™ devices.

Topic	Page
9.1 Overview	9-2
9.2 Macros	9-3
9.3 Configuration Structures	9-5
9.4 Functions	9-6

9.1 Overview

The EMIF module has a simple API for configuring the EMIF registers.

The EMIF may be configured by passing an `EMIF_Config()` structure to `EMIF_config()` or by passing register values to the `EMIF_configArgs()` function. To assist in creating register values, there are *EMIF_MK* (make) macros that construct register values based on field values. In addition, there are symbol constants that may be used for the field values.

Table 9–1 lists the configuration structure for use with the EMIF functions. Table 9–2 lists the functions and constants available in the CSL EMIF module.

Table 9–1. EMIF Configuration Structure

Structure	Purpose	See page ...
EMIF_Config	Structure used to set up the EMIF peripheral	9-5

Table 9–2. EMIF APIs

Syntax	Type	Description	See page ...
EMIF_config	F	Sets up the EMIF using the configuration structure	9-6
EMIF_configArgs	F	Sets up the EMIF using the register value arguments	9-6
EMIF_getConfig	F	Reads the current EMIF configuration values	9-8
EMIF_SUPPORT	C	A compile time constant that has a value of 1 if the device supports the EMIF module	9-8

Note: F = Function; C = Constant

9.2 Macros

There are two types of EMIF macros: those that access registers and fields, and those that construct register and field values.

Table 9–3 lists the EMIF macros that access registers and fields, and Table 9–4 lists the EMIF macros that construct register and field values. The macros themselves are found in Chapter 28, *Using the HAL Macros*.

EMIF macros are not handle based.

Table 9–3. EMIF Macros that Access Registers and Fields

Macro	Description/Purpose	See page ...
EMIF_ADDR(<REG>)	Register address	28-12
EMIF_RGET(<REG>)	Returns the value in the peripheral register	28-18
EMIF_RSET(<REG>,x)	Register set	28-20
EMIF_FGET(<REG>,<FIELD>)	Returns the value of the specified field in the peripheral register	28-13
EMIF_FSET(<REG>,<FIELD>,fieldval)	Writes <i>fieldval</i> to the specified field in the peripheral register	28-15
EMIF_FSETS(<REG>,<FIELD>,<SYM>)	Writes the symbol value to the specified field in the peripheral	28-17
EMIF_RGETA(addr,<REG>)	Gets register for a given address	28-19
EMIF_RSETA(addr,<REG>,x)	Sets register for a given address	28-20
EMIF_FGETA(addr,<REG>,<FIELD>)	Gets field for a given address	28-13
EMIF_FSETA(addr,<REG>,<FIELD>,fieldval)	Sets field for a given address	28-16
EMIF_FSETSA(addr,<REG>,<FIELD>,<SYM>)	Sets field symbolically for a given address	28-17

Table 9–4. EMIF Macros that Construct Register and Field Values

Macro	Description/Purpose	See page ...
EMIF_<REG>_DEFAULT	Register default value	28-21
EMIF_<REG>_RMK()	Register make	28-23
EMIF_<REG>_OF()	Register value of ...	28-22
EMIF_<REG>_<FIELD>_DEFAULT	Field default value	28-24
EMIF_FMK()	Field make	28-14
EMIF_FMKS()	Field make symbolically	28-15
EMIF_<REG>_<FIELD>_OF()	Field value of ...	28-24
EMIF_<REG>_<FIELD>_<SYM>	Field symbolic value	28-24

9.3 Configuration Structure

EMIF_Config *Structure used to set up EMIF peripheral*

Structure	EMIF_Config
Members	Uint32 gblctl EMIF global control register value Uint32 cectl0 CE0 space control register value Uint32 cectl1 CE1 space control register value Uint32 cectl2 CE2 space control register value Uint32 sdctl3 CE3 space control register value Uint32 cectl SDRAM control register value Uint32 sdtim SDRAM timing register value Uint32 sdext SDRAM extension register value (for 6211/6711 only)

Description This is the EMIF configuration structure used to set up the EMIF peripheral. You create and initialize this structure and then pass its address to the `EMIF_config()` function. You can use literal values or the `EMIF_MK` macros to create the structure member values.

Example

```
EMIF_Config MyConfig = { /* example for 6211/6711 */
    0x00003060, /* gblctl */
    0x00000040, /* cectl0 */
    0x404F0323, /* cectl1 */
    0x00000030, /* cectl2 */
    0x00000030, /* cectl3 */
    0x72270000, /* sdctl */
    0x00000410, /* sdtim */
    0x00000000 /* sdext */
};
...
EMIF_config(&MyConfig);
```

EMIF_config

9.4 Functions

EMIF_config *Sets up EMIF using configuration structure*

Function	<code>void EMIF_config(EMIF_Config *config);</code>
Arguments	<code>config</code> Pointer to an initialized configuration structure
Return Value	none
Description	Sets up the EMIF using the configuration structure. The values of the structure are written to the EMIF registers. See also <code>EMIF_configArgs()</code> and <code>EMIF_Config</code> .

Example

```
EMIF_Config MyConfig = { /* example for 6211/6711 */  
    0x00003060, /* gblctl */  
    0x00000040, /* cectl0 */  
    0x404F0323, /* cectl1 */  
    0x00000030, /* cectl2 */  
    0x00000030, /* cectl3 */  
    0x72270000, /* sdctl */  
    0x00000410, /* sdtim */  
    0x00000000 /* sdext */  
};  
...  
EMIF_config(&MyConfig);
```

EMIF_configArgs *Sets up EMIF using register value arguments*

Function	<code>/* for 6211/6711 only*/ void EMIF_configArgs(Uint32 gblctl, Uint32 cectl0, Uint32 cectl1, Uint32 cectl2, Uint32 cectl3, Uint32 sdctl, Uint32 sdtim, Uint32 sdext</code>
-----------------	--

```

);

/* for all other devices*/
void EMIF_configArgs(
    Uint32 gblctl,
    Uint32 cectl0,
    Uint32 cectl1,
    Uint32 cectl2,
    Uint32 cectl3,
    Uint32 sdctl,
    Uint32 sdtim
);

```

Arguments	gblctl	EMIF global control register value
	cectl0	CE0 space control register value
	cectl1	CE1 space control register value
	cectl2	CE2 space control register value
	cectl3	CE3 space control register value
	sdctl	SDRAM control register value
	sdtim	SDRAM timing register value
	sdext	SDRAM extension register value (optional – reserved for 6211/6711 only)

Return Value none

Description Sets up the EMIF using the register value arguments. The arguments are written to the EMIF registers. See also `EMIF_config()`.

Example

```

EMIF_configArgs( /* devices other than 6211/6711 */
    0x00003060, /* gblctl */
    0x00000040, /* cectl0 */
    0x404F0323, /* cectl1 */
    0x00000030, /* cectl2 */
    0x00000030, /* cectl3 */
    0x72270000, /* sdctl */
    0x00000410 /* sdtim */
);

```

EMIF_getConfig

EMIF_getConfig *Reads the current EMIF configuration values*

Function	<pre>void EMIF_getConfig(EMIF_Config *config);</pre>
Arguments	config Pointer to a configuration structure.
Return Value	none
Description	Get EMIF current configuration value
Example	<pre>EMIF_config emifCfg; EMIF_getConfig(&emifCfg);</pre>

EMIF_SUPPORT *Compile time constant*

Constant	EMIF_SUPPORT
Description	<p>Compile time constant that has a value of 1 if the device supports the EMIF module and 0 otherwise. You are not required to use this constant.</p> <p>Currently, all devices support this module.</p>
Example	<pre>#if (EMIF_SUPPORT) /* user EMIF configuration / #endif</pre>

EMIFA/EMIFB Modules

This chapter describes the EMIFA and EMIFB modules, lists the API functions and macros within the modules, and provides an API reference section.

Topic	Page
10.1 Overview	10-2
10.2 Macros	10-3
10.3 Configuration Structure	10-5
10.4 Functions	10-7

10.1 Overview

The EMIFA and EMIFB modules have simple APIs for configuring the EMIFA and EMIFB registers respectively.

The EMIFA and EMIFB may be configured by passing a configuration structure to `EMIFA_config()` and `EMIFB_config()` or by passing register values to the `EMIFA_configArgs()` and `EMIFB_configArgs()` functions. To assist in creating register values, the `EMIFA_<REG>_RMK()` and `EMIFB_<REG>_RMK()` (make) macros construct register values based on field values. In addition, the symbol constants may be used for the field values.

Table 10–1 lists the configuration structure for use with the EMIFA/EMIFB functions.

Table 10–2 lists the functions and constants available in the CSL EMIFA/EMIFB modules.

Table 10–1. EMIFA/EMIFB Configuration Structure

Syntax	Type	Description	See page ...
EMIFA_Config EMIFB_Config	S	Structure used to set up the EMIFA(B) peripheral	10-5

Table 10–2. EMIFA/EMIFB APIs

Syntax	Type	Description	See page ...
EMIFA_config EMIFB_config	F	Sets up the EMIFA(B) using the configuration structure	10-7
EMIFA_configArgs EMIFB_configArgs	F	Sets up the EMIFA(B) using the register value arguments	10-9
EMIFA_getConfig EMIFB_getConfig	F	Reads the current EMIFA(B) configuration values	10-11
EMIFA_SUPPORT EMIFB_SUPPORT	C	A compile time constant that has a value of 1 if the device supports the EMIFA and/or EMIFB modules	10-11

Note: F = Function; C = Constant

10.2 Macros

There are two types of macros: those that access registers and fields, and those that construct register and field values.

Table 10–3 lists the EMIFA and EMIFB macros that access registers and fields, and Table 10–4 lists the EMIFA and EMIFB macros that construct register and field values. The macros themselves are found in Chapter 28, *Using the HAL Macros*.

EMIFA and EMIFB macros are not handle-based.

Table 10–3. EMIFA/EMIFB Macros that Access Registers and Fields

Macro	Description/Purpose	See page ...
EMIFA_ADDR(<REG>) EMIFB_ADDR(<REG>)	Register address	28-12
EMIFA_RGET(<REG>) EMIFB_RGET(<REG>)	Return the value in the peripheral register	28-18
EMIFA_RSET(<REG>,x) EMIFB_RSET(<REG>,x)	Register set	28-20
EMIFA_FGET(<REG>,<FIELD>) EMIFB_FGET(<REG>,<FIELD>)	Return the value of the specified field in the peripheral register	28-13
EMIFA_FSET(<REG>,<FIELD>,fieldval) EMIFB_FSET(<REG>,<FIELD>,fieldval)	Write <i>fieldval</i> to the specified field in the peripheral register	28-13
EMIFA_FSETS(<REG>,<FIELD>,<SYM>) EMIFB_FSETS(<REG>,<FIELD>,<SYM>)	Write the symbol value to the specified field in the peripheral	28-17
EMIFA_RGETA(addr,<REG>) EMIFB_RGETA(addr,<REG>)	Get register for a given address	28-19
EMIFA_RSETA(addr,<REG>,x) EMIFB_RSETA(addr,<REG>,x)	Set register for a given address	28-20
EMIFA_FGETA(addr,<REG>,<FIELD>) EMIFB_FGETA(addr,<REG>,<FIELD>)	Get field for a given address	28-13
EMIFA_FSETA(addr,<REG>,<FIELD>,x) EMIFB_FSETA(addr,<REG>,<FIELD>,x)	Set field for a given address	28-16
EMIFA_FSETSA(addr,<REG>,<FIELD>,<SYM>) EMIFB_FSETSA(addr,<REG>,<FIELD>,<SYM>)	Set field symbolically for a given address	28-12

Table 10–4. EMIFA/EMIFB Macros that Construct Register and Field Values

Macro	Description/Purpose	See page ...
EMIFA_<REG>_DEFAULT EMIFB_<REG>_DEFAULT	Register default value	28-21
EMIFA_<REG>_RMK() EMIFB_<REG>_RMK()	Register make	28-23
EMIFA_<REG>_OF() EMIFB_<REG>_OF()	Register value of ...	28-22
EMIFA_<REG>_<FIELD>_DEFAULT EMIFB_<REG>_<FIELD>_DEFAULT	Field default value	28-24
EMIFA_FMK() EMIFB_FMK()	Field make	28-14
EMIFA_FMKS() EMIFB_FMKS()	Field make symbolically	28-15
EMIFA_<REG>_<FIELD>_OF() EMIFB_<REG>_<FIELD>_OF()	Field value of ...	28-24
EMIFA_<REG>_<FIELD>_<SYM> EMIFB_<REG>_<FIELD>_<SYM>	Field symbolic value	28-24

10.3 Configuration Structure

EMIFA_Config EMIFB_Config

Structures used to set up EMIFA and EMIFB peripherals

Structure	EMIFA_Config EMIFB_Config
Members	Uint32 gblctl EMIFA(B)global control register value Uint32 cectl0 CE0 space control register value Uint32 cectl1 CE1 space control register value Uint32 cectl2 CE2 space control register value Uint32 cectl3 CE3 space control register value Uint32 sdctl SDRAM control register value Uint32 sdtim SDRAM timing register value Uint32 sdext SDRAM extension register value Uint32 cesec0 CE0 space secondary control register value Uint32 cesec1 CE1 space secondary control register value Uint32 cesec2 CE2 space secondary control register value Uint32 cesec3 CE3 space secondary control register value
Description	<p>These are the EMIFA and EMIFB configuration structures used to set up the EMIFA and EMIFB peripherals, respectively. You create and initialize these structures and then pass their addresses to the <code>EMIFA_config()</code> and <code>EMIFB_config()</code> functions. You can use literal values or the <code>EMIFA_<REG>_RMK</code> and <code>EMIFB_<REG>_RMK</code> macros to create the structure member values.</p>

EMIFA_Config EMIFB_Config

Example

```
EMIFA_Config MyConfigA = {
    0x00003060, /* gblctl */
    0x00000040, /* cectl0 */
    0x404F0323, /* cectl1 */
    0x00000030, /* cectl2 */
    0x00000030, /* cectl3 */
    0x07117000, /* sdctl */
    0x00000610, /* sdtim */
    0x00000000, /* sdext */
    0x00000000, /* cesec0 */
    0x00000000, /* cesec1 */
    0x00000000, /* cesec2 */
    0x00000000 /* cesec3 */
};

EMIFB_Config MyConfigB = {
    0x00003060, /* gblctl */
    0x00000040, /* cectl0 */
    0x404F0323, /* cectl1 */
    0x00000030, /* cectl2 */
    0x00000030, /* cectl3 */
    0x07117000, /* sdctl */
    0x00000610, /* sdtim */
    0x00000000, /* sdext */
    0x00000000, /* cesec0 */
    0x00000000, /* cesec1 */
    0x00000000, /* cesec2 */
    0x00000000 /* cesec3 */
};

...
EMIFA_config(&MyConfigA);
EMIFB_config(&MyConfigB);
```

10.4 Functions

**EMIFA_config
EMIFB_config**

Sets up EMIFA and EMIFB using configuration structures

Function

```
void EMIFA_config(  
    EMIFA_Config *config  
);
```

```
void EMIFB_config(  
    EMIFB_Config *config  
);
```

Arguments

config Pointer to an initialized configuration structure

Return Value

none

Description

Sets up the EMIFA and/or EMIFB using the configuration respective structures. The values of the structures are written to the EMIFA and EMIFB registers respectively.

EMIFA_config EMIFB_config

Example

```
EMIFA_Config MyConfigA = {
    0x00003060, /* gblctl */
    0x00000040, /* cectl0 */
    0x404F0323, /* cectl1 */
    0x00000030, /* cectl2 */
    0x00000030, /* cectl3 */
    0x07117000, /* sdctl */
    0x00000610, /* sdtim */
    0x00000000, /* sdext */
    0x00000000, /* cesec0 */
    0x00000000, /* cesec1 */
    0x00000000, /* cesec2 */
    0x00000000, /* cesec3 */
};

EMIFB_Config MyConfigB = {
    0x00003060, /* gblctl */
    0x00000040, /* cectl0 */
    0x404F0323, /* cectl1 */
    0x00000030, /* cectl2 */
    0x00000030, /* cectl3 */
    0x07117000, /* sdctl */
    0x00000610, /* sdtim */
    0x00000000, /* sdext */
    0x00000000, /* cesec0 */
    0x00000000, /* cesec1 */
    0x00000000, /* cesec2 */
    0x00000000, /* cesec3 */
};

...
EMIFA_config(&MyConfigA);
EMIFB_config(&MyConfigB);
```

EMIFA_configArgs
EMIFB_configArgs

Sets up EMIFA and EMIFB using register value arguments

Function

```
void EMIFA_configArgs(
    Uint32 gblctl,
    Uint32 cectl0,
    Uint32 cectl1,
    Uint32 cectl2,
    Uint32 cectl3,
    Uint32 sdctl,
    Uint32 sdtim,
    Uint32 sdext,
    Uint32 cesec0,
    Uint32 cesec1,
    Uint32 cesec2,
    Uint32 cesec3
);
```

```
void EMIFB_configArgs(
    Uint32 gblctl,
    Uint32 cectl0,
    Uint32 cectl1,
    Uint32 cectl2,
    Uint32 cectl3,
    Uint32 sdctl,
    Uint32 sdtim,
    Uint32 sdext,
    Uint32 cesec0,
    Uint32 cesec1,
    Uint32 cesec2,
    Uint32 cesec3
);
```

Arguments

gblctl	EMIFA(B) global control register value
cectl0	CE0 space control register value
cectl1	CE1 space control register value
cectl2	CE2 space control register value
cectl3	CE3 space control register value
sdctl	SDRAM control register value
sdtim	SDRAM timing register value
sdext	SDRAM extension register value
cesec0	CE0 space secondary register value
cesec1	CE1 space secondary register value

EMIFA_configArgs EMIFB_configArgs

cesec2 CE2 space secondary register value
cesec3 CE3 space secondary register value

Return Value none

Description Set up the EMIFA and EMIFB using the register value arguments. The arguments are written to the EMIFA and EMIFB registers respectively. See also EMIFA_config(), EMIFB_config() functions.

Example

```
EMIFA_configArgs(  
    0x00003060, /* gblctl */  
    0x00000040, /* cectl0 */  
    0x404F0323, /* cectl1 */  
    0x00000030, /* cectl2 */  
    0x00000030, /* cectl3 */  
    0x07117000, /* sdctl */  
    0x00000610, /* sdtim */  
    0x00000000, /* sdext */  
    0x00000000, /* cesec0 */  
    0x00000000, /* cesec1 */  
    0x00000000, /* cesec2 */  
    0x00000000 /* cesec3 */  
);
```

```
EMIFB_configArgs(  
    0x00003060, /* gblctl */  
    0x00000040, /* cectl0 */  
    0x404F0323, /* cectl1 */  
    0x00000030, /* cectl2 */  
    0x00000030, /* cectl3 */  
    0x07117000, /* sdctl */  
    0x00000610, /* sdtim */  
    0x00000000, /* sdext */  
    0x00000000, /* cesec0 */  
    0x00000000, /* cesec1 */  
    0x00000000, /* cesec2 */  
    0x00000000 /* cesec3 */  
);
```

**EMIFA_getConfig
EMIFB_getConfig***Reads the current EMIFA and EMIFB configuration values*

Function	<pre>void EMIFA_getConfig(EMIFA_Config *config); void EMIFB_getConfig(EMIFB_Config *config);</pre>
Arguments	config Pointer to a configuration structure.
Return Value	none
Description	Get EMIFA and EMIFB current configuration values.
Example	<pre>EMIFA_config emifCfgA; EMIFB_config emifCfgB; EMIFA_getConfig(&emifCfgA); EMIFB_getConfig(&emifCfgB);</pre>

**EMIFA_SUPPORT
EMIFB_SUPPORT***Compile-time constants*

Constant	EMIFA_SUPPORT EMIFB_SUPPORT
Description	Compile time constants that have a value of 1 if the device supports the EMIFA and EMIFB modules respectively, and 0 otherwise. You are not required to use this constant. Currently, all devices support this module.
Example	<pre>#if (EMIFA_SUPPORT) /* user EMIFA configuration / #endif</pre>

GPIO Module

This chapter describes the GPIO module, lists the GPIO functions and macros within the module, and provides a GPIO API reference section.

Topic	Page
11.1 Overview	11-2
11.2 Macros	11-5
11.3 Configuration Structure	11-7
11.4 Functions	11-8

11.1 Overview

For TMS320C64x™ devices, the GPIO peripheral provides 16 dedicated general-purpose pins that can be configured as either inputs or outputs. Each GPx pin configured as an input can directly trigger a CPU interrupt or a GPIO event. The properties and functionalities of the GPx pins are covered by a set of CSL APIs.

Table 11–1 lists the configuration structure for use with the GPIO functions. Table 11–2 lists the functions and constants available in the CSL GPIO module.

Table 11–1. GPIO Configuration Structure

Syntax	Type	Description	See page ...
GPIO_Config	S	The GPIO configuration structure used to set the GPIO Global control register	11-7

Table 11–2. GPIO APIs

(a) Primary GPIO Functions

Syntax	Type	Description	See page ...
GPIO_close	F	Closes a GPIO port previously opened via <code>GPIO_open()</code>	11-8
GPIO_config	F	Sets up the GPIO global control register using the configuration structure	11-8
GPIO_configArgs	F	Sets up the GPIO global control register using the register values passed in	11-9
GPIO_open	F	Opens a GPIO port for use	11-10
GPIO_reset	C	Resets the given GPIO channel	11-10

(b) Auxiliary GPIO Functions

Syntax	Type	Description	See page ...
GPIO_clear	F	Clears the GPIO Delta registers	11-11
GPIO_deltaLowClear	F	Clears bits of given input pins in Delta Low register	11-11
GPIO_deltaLowGet	F	Indicates if a given input pin has undergone a high-to-low transition. Returns 0 if the transition is not detected.	11-12

Syntax	Type	Description	See page ...
GPIO_deltaHighClear	F	Clears the bit of a given input pin in Delta High register	11-12
GPIO_deltaHighGet	F	Indicates if a given input pin has undergone a low-to-high transition. Returns 0 if the transition is not detected.	11-13
GPIO_getConfig	F	Reads the current GPIO configuration structure	11-13
GPIO_GPINTx	C	Constants dedicated to GPIO interrupt/event signals: GPIO_GPINT0, GPIO_GPINT4, GPIO_GPINT5, GPIO_GPINT6, GPIO_GPINT7	11-14
GPIO_intPolarity	F	Sets the polarity of the GPINTx interrupt/event signals when configured in Pass Through mode	11-14
GPIO_maskLowClear	F	Clears the bits of given input pins in Mask Low register	11-15
GPIO_maskLowSet	F	Enables given pins to cause a CPU interrupt or EDMA event based on corresponding GPxDL or inverted GPxVAL by setting the associated mask bit.	11-15
GPIO_maskHighClear	F	Clears the bits of input pins in Mask High register	11-16
GPIO_maskHighSet	F	Enables given pins to cause a CPU interrupt or EGPIO event based on corresponding GPxDH or GPxVAL by setting the associated mask bit.	11-16
GPIO_pinDisable	F	Disables given pins under the Global Enable register	11-17
GPIO_pinDirection	F	Sets the direction of the given pins. Applies only if the corresponding pins are enabled.	11-17
GPIO_pinEnable	F	Enables the given pins under the Global Enable register	11-18
GPIO_pinRead	F	Reads the detected values of pins configured as inputs and the values to be driven on given output pins.	11-18
GPIO_pinWrite	F	Writes the values to be driven on given output pins.	11-19
GPIO_PINx	C	Constants dedicated to GPIO pins: GPIO_PIN0 –GPIO_PIN15.	11-19
GPIO_read	C	Reads data from a set of pins.	11-20
GPIO_SUPPORT	C	A compile time constant whose value is 1 if the device supports the GPIO module.	11-20
GPIO_write	C	Writes the value to the specified set of GPIO pins.	11-20

Note: F = Function; C = Constant

11.1.1 Using GPIO

To use the GPIO pins, you must first allocate a device using `GPIO_open()`, and then configure the Global Control register to determine the peripheral mode by using the configuration structure to `GPIO_config()` or by passing register value to the `GPIO_configArgs()` function. To assist in creating register values, there are `GPIO_<REG>_RMK` (make) macros that construct register value based on field values. In addition, there are symbol constants that may be used for the field values.

Note that most functions apply to enabled pins only. In order to enable the pins, `GPIO_enablePins()` must be called before using any other functions on these pins.

Important note for C64x users: Migration CSL 2.1 to CSL 2.2

All GPIO APIs have changed with the addition of the handle passed as an input parameter. Although it is possible to include the header file `<csl_legacy.h>` to avoid any changes to the user's code, it is strongly recommended to update the APIs using the handle-based methodology described in section 1.7.1, Using CSL Handles.

11.2 Macros

There are two types of GPIO macros: those that access registers and fields, and those that construct register and field values.

Table 11–3 lists the GPIO macros that access registers and fields, and Table 11–4 lists the GPIO macros that construct register and field values. The macros themselves are found in Chapter 28, *Using the HAL Macros*.

The GPIO module includes handle-based macros.

Table 11–3. GPIO Macros that Access Registers and Fields

Macro	Description/Purpose	See page ...
GPIO_ADDR(<REG>)	Register address	28-12
GPIO_RGET(<REG>)	Returns the value in the peripheral register	28-18
GPIO_RSET(<REG>,x)	Register set	28-20
GPIO_FGET(<REG>,<FIELD>)	Returns the value of the specified field in the peripheral register	28-13
GPIO_FSET(<REG>,<FIELD>,fieldval)	Writes <i>fieldval</i> to the specified field in the peripheral register	28-15
GPIO_FSETS(<REG>,<FIELD>,<SYM>)	Writes the symbol value to the specified field in the peripheral	28-17
GPIO_RGETA(addr,<REG>)	Gets register for a given address	28-19
GPIO_RSETA(addr,<REG>,x)	Sets register for a given address	28-20
GPIO_FGETA(addr,<REG>,<FIELD>)	Gets field for a given address	28-13
GPIO_FSETA(addr,<REG>,<FIELD>,fieldval)	Sets field for a given address	28-16
GPIO_FSETSA(addr,<REG>,<FIELD>,<SYM>)	Sets field symbolically for a given address	28-17
GPIO_ADDRH(h,<REG>)	Returns the address of a memory-mapped register for a given handle	
GPIO_RGETH(h,<REG>)	Returns the value of a register for a given handle	
GPIO_RSETH(h,<REG>,x)	Sets the register value to x for a given handle	
GPIO_FGETH(h,<REG>,<FIELD>)	Returns the value of the field for a given handle	

Table 11–3. GPIO Macros that Access Registers and Fields (Continued)

Macro	Description/Purpose	See page ...
GPIO_FSETH(h,<REG>,<FIELD>, fieldval)	Sets the field value to x for a given handle	
GPIO_FSETSH(h,<REG>,<FIELD>, <SYM>)	Sets field for a given address	

Table 11–4. GPIO Macros that Construct Register and Field Values

Macro	Description/Purpose	See page ...
GPIO_<REG>_DEFAULT	Register default value	28-21
GPIO_<REG>_RMK()	Register make	28-23
GPIO_<REG>_OF()	Register value of ...	28-22
GPIO_<REG>_<FIELD>_DEFAULT	Field default value	28-24
GPIO_FMK()	Field make	28-14
GPIO_FMKS()	Field make symbolically	28-15
GPIO_<REG>_<FIELD>_OF()	Field value of ...	28-24
GPIO_<REG>_<FIELD>_<SYM>	Field symbolic value	28-24

11.3 Configuration Structure

GPIO_Config *GPIO configuration structure used to set up GPIO registers*

Structure GPIO_Config

Members

UInt32 gpgc	GPIO Global control register value
UInt32 gpen	GPIO Enable register value
UInt32 gpdire	GPIO Direction register value
UInt32 gpval	GPIO Value register value
UInt32 gphm	GPIO High Mask register value
UInt32 gplm	GPIO Low Mask register value
UInt32 gppol	GPIO Interrupt Polarity register value

Description This is the GPIO configuration structure used to set up the GPIO registers. You create and initialize this structure, then pass its address to the `GPIO_config()` function. You can use literal values or the `_RMK` macros to create the structure register value.

Example

```
GPIO_Config MyConfig = {
    0x00000031, /* gpgc */
    0x000000F9, /* gpen */
    0x00000070, /* gdir */
    0x00000082, /* gpval */
    0x00000000, /* gphm */
    0x00000000, /* gplm */
    0x00000030 /* gppol */
};

...
GPIO_config(hGpio, &MyConfig);
```

GPIO_close

11.4 Functions

11.4.1 Primary GPIO Functions

GPIO_close	<i>Closes GPIO channel previously opened via GPIO_open()</i>
Function	<pre>void GPIO_close(GPIO_Handle hGpio);</pre>
Arguments	<pre>hGpio Handle to GPIO device, see GPIO_open()</pre>
Return Value	none
Description	This function closes a GPIO channel previously opened via <code>GPIO_open()</code> . This function accepts the following device handle: From <code>GPIO_open()</code> .
Example	<pre>GPIO_close(hGpio);</pre>
GPIO_config	<i>Sets up GPIO modes using a configuration structure</i>
Function	<pre>void GPIO_config(GPIO_Handle hGpio, GPIO_Config *config);</pre>
Arguments	<pre>hGpio Handle to GPIO device, see GPIO_open() config Pointer to an initialized configuration structure</pre>
Return Value	none
Description	Sets up the GPIO mode using the configuration structure. The values of the structure are written to the GPIO Global control register. See also <code>GPIO_configArgs()</code> and <code>GPIO_Config</code> .
Example	<pre>GPIO_Config MyConfig = { 0x00000031, /* gpgc */ GPIO_GPEN_RMK(0x000000F9), /* gpen */ 0x00000070, /* gdir */ 0x00000082, /* gpval */ 0x00000000, /* gphm */ 0x00000000, /* gplm */ 0x00000030 /* gppol */ }; ... GPIO_config(hGpio, &MyConfig);</pre>

GPIO_configArgs Sets up GPIO mode using register value passed in

Function	<pre>void GPIO_configArgs(GPIO_Handle hGpio, Uint32 gpgc, Uint32 gpen, Uint32 gpdir, Uint32 gpval, Uint32 gphm, Uint32 gplm, Uint32 gppol);</pre>																
Arguments	<table> <tr> <td>hGpio</td> <td>Handle to GPIO device, see GPIO_open()</td> </tr> <tr> <td>gpgc</td> <td>Global control register value</td> </tr> <tr> <td>gpen</td> <td>GPIO Enable register value</td> </tr> <tr> <td>gpdir</td> <td>GPIO Direction register value</td> </tr> <tr> <td>gpval</td> <td>GPIO Value register value</td> </tr> <tr> <td>gphm</td> <td>GPIO High Mask register value</td> </tr> <tr> <td>gplm</td> <td>GPIO Low Mask register value</td> </tr> <tr> <td>gppol</td> <td>GPIO Interrupt Polarity register value</td> </tr> </table>	hGpio	Handle to GPIO device, see GPIO_open()	gpgc	Global control register value	gpen	GPIO Enable register value	gpdir	GPIO Direction register value	gpval	GPIO Value register value	gphm	GPIO High Mask register value	gplm	GPIO Low Mask register value	gppol	GPIO Interrupt Polarity register value
hGpio	Handle to GPIO device, see GPIO_open()																
gpgc	Global control register value																
gpen	GPIO Enable register value																
gpdir	GPIO Direction register value																
gpval	GPIO Value register value																
gphm	GPIO High Mask register value																
gplm	GPIO Low Mask register value																
gppol	GPIO Interrupt Polarity register value																
Return Value	none																
Description	<p>Sets up the GPIO mode using the register value passed in. The register value is written to the GPIO Global Control register. See also GPIO_config().</p> <p>You may use literal values for the arguments or for readability. You may use the <i>_RMK</i> macros to create the register values based on field values.</p>																
Example	<pre>GPIO_configArgs(hGpio, 0x00000031, /* gpgc */ 0x000000F9, /* gpen */ 0x00000070, /* gdir */ 0x00000082, /* gpval */ 0x00000000, /* gphm */ 0x00000000, /* gplm */ 0x00000030 /* gppol */);</pre>																

GPIO_reset

GPIO_reset *Resets a given GPIO channel*

Function	<pre>void GPIO_reset(GPIO_Handle hGpio);</pre>
Arguments	<code>hGpio</code> Device handle obtained by <code>GPIO_open()</code>
Return Value	none
Description	Resets the given GPIO channel. The registers are set to their default values, with the exceptions of the Delta High and Delta Low registers, which may be cleared using the <code>GPIO_clear()</code> function.
Example	<pre>GPIO_reset(hGpio);</pre>

GPIO_open *Opens GPIO device*

Function	<pre>GPIO_Handle GPIO_open(int chNum, Uint32 flags);</pre>
Arguments	<code>hGpio</code> Handle to GPIO device, see <code>GPIO_open()</code> <code>chNum</code> GPIO channel to open: <input type="checkbox"/> <code>GPIO_DEV0</code> <code>flags</code> Open flags; may be logical OR of any of the following: <input type="checkbox"/> <code>GPIO_OPEN_RESET</code>
Return Value	Device Handle Returns a device handle to be used by other GPIO API function calls
Description	<p>Before a GPIO device can be used, it must first be opened by this function. Once opened, it cannot be opened again until closed. See <code>GPIO_close()</code>. The return value is a unique device handle that is used in subsequent GPIO API calls. If the open fails, <code>INV</code> is returned.</p> <p>If the <code>GPIO_OPEN_RESET</code> is specified, the GPIO channel is reset, the channel interrupt is disabled and cleared. If the device cannot be opened, <code>INV</code> is returned.</p>
Example	<pre>GPIO_Handle hGpio; ... hGpio = GPIO_open(GPIO_DEV0, GPIO_OPEN_RESET); ...</pre>

11.4.2 Auxiliary GPIO Functions and Constants

GPIO_clear *Clears GPIO Delta registers*

Function	void GPIO_clear(GPIO_Handle hGpio);
Arguments	hGpio Handle to GPIO device, see GPIO_open()
Return Value	none
Description	This function clears the GPIO Delta Low (GPD_L) and Delta High (GPD_H) registers by writing 1 to every bit in these registers.
Example	GPIO_clear(hGpio);

GPIO_deltaLowClear *Clears bits of given input pins in Delta Low Register*

Function	void GPIO_deltaLowClear(GPIO_Handle hGpio, Uint32 pinId);
Arguments	hGpio Handle to GPIO device, see GPIO_open() pinId Pin ID to the associated pin to be cleared
Return Value	none
Description	This function clears the bits of given pins register in Delta Low Register.
Example	<pre>/* Clears one pin */ GPIO_deltaLowClear (hGpio,GPIO_PIN2); /* Clears several pins */ Uint32 PinID= GPIO_PIN2 GPIO_PIN3; GPIO_deltaLowClear (hGpio,PinID);</pre>

GPIO_deltaLowGet

GPIO_deltaLowGet *Returns high-to-low transition detection status for given input pins*

Function `Uint32 GPIO_deltaLowGet(
 GPIO_Handle hGpio,
 Uint32 pinId
);`

Arguments `hGpio` Handle to GPIO device, see `GPIO_open()`

`pinId` Pin ID to the associated pin to be cleared

Return Value `status` Returns the transition detection status of pinID.

Description This function indicates if a given input pin has undergone a high-to-low transition. Returns the status of the transition detection for the pins associated with the pinId.

Example

```
/* Get transition Detection Status for pin2 */
Uint32 detectionHL;
detectionHL = GPIO_deltaLowGet (hGpio,GPIO_PIN2);
/* Get transition Detection Status for several pins */
Uint32 PinID= GPIO_PIN2 | GPIO_PIN3;
Uint32 detectionHL;
detectionHL = GPIO_deltaLowGet (hGpio,PinID);
/* detectionHL can take the following values :      */
/* 0x00000000 : No high-low transition detected    */
/* 0x00000004 : transition detected for GP2 */
/* 0x00000008 : transition detected for GP3 */
/* 0x0000000C : transitions detected for GP2 and GP3 */
```

GPIO_deltaHighClear *Clears bits of given input pins in Delta High Register*

Function `void GPIO_deltaHighClear(
 GPIO_Handle hGpio,
 Uint32 pinId
);`

Arguments `hGpio` Handle to GPIO device, see `GPIO_open()`

`pinId` Pin ID to the associated pin to be cleared

Return Value none

Description This function clears the bits of given pin register in Delta High Register.

Example

```

/* Clears one pin */
GPIO_deltaHighClear (hGpio,GPIO_PIN2);
/* Clears several pins */
Uint32 PinID= GPIO_PIN2 | GPIO_PIN3;
GPIO_deltaHighClear (hGpio,PinID);

```

GPIO_deltaHighGet *Returns low-to-high transition detection status for given input pins*

Function

```

Uint32 GPIO_deltaHighGet(
    GPIO_Handle  hGpio,
    Uint32       pinId
);

```

Arguments

hGpio Handle to GPIO device, see GPIO_open()

pinId Pin ID to the associated pin to be cleared

Return Value status Returns the transition detection status of pinID.

Description This function indicates if a given input pin has undergone a low-to-high transition. Returns the status of the transition detection for the pins associated to the pinId.

Example

```

/* Get transition Detection Status for pin2 */
Uint32 detectionLH;
detectionLH = GPIO_deltaHighGet (hGpio,GPIO_PIN2);
/* Get transition Detection Status for several pins */
Uint32 PinID= GPIO_PIN2 | GPIO_PIN3;
Uint32 detectionLH;
detectionLH = GPIO_deltaHighGet (hGpio,PinID);
/* detectionLH can take the following values : */
/* 0x00000000 : no high-low transitions detected*/
/* 0x00000004 : transition detected for GP2 */
/* 0x00000008 : transition detected for GP3 */
/* 0x0000000C : transitions detected for GP2 and GP3 */

```

GPIO_getConfig *Reads the current GPIO Configuration Structure*

Function

```

void GPIO_getConfig(
    GPIO_Handle  hGpio,
    GPIO_Config  *Config
);

```

Arguments

hGpio Handle to GPIO device, see GPIO_open()

Config Pointer to a configuration structure.

GPIO_GPINTx

Return Value	none
Description	Get GPIO current configuration value
Example	<pre>GPIO_config GPIOCfg; GPIO_getConfig(hGpio, &GPIOCfg);</pre>

GPIO_GPINTx *Compiler constant dedicated to identify GPIO interrupt/event pins*

Constant	GPIO_GPINTx with x={0,4,5,6,7}
Description	<p>Set of constants that takes the value of the masks of the associated interrupt/event pins.</p> <p>These constants are used by the GPIO functions that use signal as the input parameter. Bits of several pins can be set simultaneously by using the logic OR between the masks. See GPIO_intPolarity().</p>
Example	<pre>GPIO_intPolarity(GPIO_GPINT7, GPIO_RISING); GPIO_intPolarity(GPIO_GPINT8, GPIO_FALLING);</pre>

GPIO_intPolarity *Sets the polarity of the GPINTx interrupt/event signals*

Function	<pre>void GPIO_intPolarity(GPIO_Handle hGpio, Uint32 signal, Uint32 polarity);</pre>
Arguments	<p>hGpio Handle to GPIO device, see GPIO_open()</p> <p>signal The interrupt/event signal to be configured</p> <p>polarity Polarity of the given signal , 2 constants are predefined <input type="checkbox"/> GPIO_RISING <input type="checkbox"/> GPIO_FALLING</p>
Return Value	none

GPIO_maskLowClear *Clears bits which cause a CPU interrupt or EDMA event*

Function	<pre>void GPIO_maskLowClear(GPIO_Handle hGpio, Uint32 pinId);</pre>
Arguments	<p>hGpio Handle to GPIO device, see GPIO_open ()</p> <p>pinId Pin ID to the associated pin to be cleared</p>
Return Value	none
Description	This function clears the bits of given pins in Mask Low Register. See also GPIO_maskLowSet () function.
Example	<pre>/* Clears one pin mask */ GPIO_maskLowClear (hGpio,GPIO_PIN2); /* Clears several pins */ Uint32 PinID= GPIO_PIN2 GPIO_PIN3; GPIO_maskLowClear (hGpio,PinID);</pre>

GPIO_maskLowSet *Sets bits which cause a CPU interrupt or EDMA event*

Function	<pre>void GPIO_maskLowSet(GPIO_Handle hGpio, Uint32 pinId);</pre>
Arguments	<p>hGpio Handle to GPIO device, see GPIO_open ()</p> <p>pinId Pin ID to the associated pin to be set</p>
Return Value	none
Description	This function sets the bits of given pins to generate an interrupt/event based on corresponding GPxDL or inverted GPxVAL values. See also the GPIO_maskLowClear () function.
Example	<pre>/* Sets one pin mask */ GPIO_maskLowSet (hGpio,GPIO_PIN2); /* Sets several pins */ Uint32 PinID= GPIO_PIN2 GPIO_PIN3; GPIO_maskLowSet (hGpio,PinID);</pre>

GPIO_maskHighClear

GPIO_maskHighClear *Clears bits which cause a CPU interrupt or EDMA event*

Function void GPIO_maskHighClear(
 GPIO_Handle hGpio,
 Uint32 pinId
);

Arguments hGpio Handle to GPIO device, see GPIO_open()

 pinId Pin ID to the associated pin to be cleared

Return Value none

Description This function clears the bits of given pins in Mask High Register. See also
GPIO_maskHighSet() function.

Example /* Clears one pin mask */
 GPIO_maskHighClear (hGpio,GPIO_PIN2);
 /* Clears several pins */
 Uint32 PinID= GPIO_PIN2 | GPIO_PIN3;
 GPIO_maskHighClear (hGpio,PinID);

GPIO_maskHighSet *Sets bits which cause a CPU interrupt or EDMA event*

Function void GPIO_maskHighSet(
 GPIO_Handle hGpio,
 Uint32 pinId
);

Arguments hGpio Handle to GPIO device, see GPIO_open()

 pinId Pin ID to the associated pin to be set

Return Value none

Description This function sets the bits of given pins to generate an interrupt/event based
on corresponding GPxDH or GPxVAL values. See also the
GPIO_maskHighClear() function.

Example /* Sets one pin mask */
 GPIO_maskHighSet (hGpio,GPIO_PIN2);
 /* Sets several pins */
 Uint32 PinID= GPIO_PIN2 | GPIO_PIN3;
 GPIO_maskHighSet (hGpio,PinID);

GPIO_pinDisable *Disables the General Purpose Input/Output pins*

Function	void GPIO_pinDisable (GPIO_Handle hGpio, Uint32 pinId);
Arguments	hGpio Handle to GPIO device, see GPIO_open() pinId pin ID to the associated pin to be cleared
Return Value	none
Description	This function disables the given GPIO pins by setting the associated bits to 0 under the GPEN register. This function is used after having enabled some pins. See also the GPIO_pinEnable() function.
Example	<pre>/* Enables Pins */ GPIO_pinEnable(hGpio,GPIO_PIN1 GPIO_PIN2 GPIO_PIN3); ... /* Disable GP1 pin */ GPIO_pinDisable(hGpio,GPIO_PIN1);</pre>

GPIO_pinDirection *Sets the direction of the given pins as input or output*

Function	Uint32 GPIO_pinDirection(GPIO_Handle hGpio, Uint32 pinId);
Arguments	hGpio Handle to GPIO device, see GPIO_open() pinId Pin ID to the associated pin to be cleared direction Determines the direction of the given pins, 2 constants are predefined: <input type="checkbox"/> GPIO_INPUT <input type="checkbox"/> GPIO_OUTPUT
Return Value	CurrentSet Returns the current pin direction setting
Description	This function sets the associated direction bits of given pins as input or output. Applies only if the given are enabled previously.

GPIO_pinEnable

Example

```
Uint32 Current_dir;
/* Sets GP1 as input pin */
Current_dir = GPIO_pinDirection(hGpio,GPIO_PIN1,GPIO_INPUT);
/* Sets GP2 and GP3 as output pins */
Uint32 PinID= GPIO_PIN2 | GPIO_PIN3;
Current_dir = GPIO_pinDirection(hGpio,PinID,GPIO_OUTPUT);
```

GPIO_pinEnable *Enables the General Purpose Input/Output pins*

Function

```
void GPIO_pinEnable(
    GPIO_Handle hGpio,
    Uint32      pinId
);
```

Arguments

hGpio Handle to GPIO device, see GPIO_open()

pinId Pin ID to the associated pin to be cleared

Return Value

none

Description

This function enables the given GPIO pins by setting the associated bits to 1 under the GPEN register. This function is used after using the given pins as GPIO pins. See also the GPIO_pinDisable() function.

Example

```
/* Enables Pins */
GPIO_pinEnable(hGpio,GPIO_PIN1 | GPIO_PIN2 | GPIO_PIN3);
```

GPIO_pinRead *Gets value of given pins*

Function

```
Uint32 GPIO_pinRead(
    GPIO_Handle hGpio,
    Uint32      pinId
);
```

Arguments

hGpio Handle to GPIO device, see GPIO_open()

pinId Pin ID to the associated pin to be set

Return Value

val 0 or 1

Description

If the specified pin has been previously configured as an input, this function returns the value "0" or "1". If the specified pin has been configured as an output pin, this function returns the value to be driven on the pin.

Example

```

Uint32 val;
/* returns value of pin #2 */
val = GPIO_pinRead (hGpio,GPIO_PIN2);

```

GPIO_pinWrite *Writes value of given output pins*

Function

```

void GPIO_pinWrite(
    GPIO_Handle  hGpio,
    Uint32      pinId,
    Uint32      val
);

```

Arguments

hGpio Handle to GPIO device, see GPIO_open()

pinId Pin ID to the associated pin to be set

val Value to be driven on the given output pin: 0 or 1

Return Value none

Description This function sets the value 0 or 1 to be driven on given output pins.

Example

```

Uint32 val;
/* Sets value of one pin to 1*/
GPIO_pinWrite(hGpio,GPIO_PIN2,1);
/* Sets values of several pins to 0*/
Uint32 PinID= GPIO_PIN2 | GPIO_PIN3;
GPIO_ pinWrite(hGpio,PinID,0);

```

GPIO_PINx *Compile constant dedicated to identify each GPIO pin*

Constant GPIO_PINx with x from 0 to 15

Description Set of constants that takes the value of the masks of the associated pins.

These constants are used by the GPIO functions that use pinID as the input parameter. Bits of several pins can be set simultaneously by using the logic OR between the masks.

Example

```

/* Enables pins */
GPIO_pinEnable (hGpio,GPIO_PIN2 | GPIO_PIN3);
/* Sets Pin3 as an output pin */
Current_dir = GPIO_pinDirection(hGpio,GPIO_PIN3, 1)
/* Sets one pin mask */
GPIO_maskHighSet (hGpio,GPIO_PIN2);

```

GPIO_read

GPIO_read

Reads data from a set of pins

Function	<pre>Uint32 GPIO_read(GPIO_Handle hGpio, Uint32 pinMask);</pre>
Arguments	<p>hGpio Handle to GPIO device, see <code>GPIO_open()</code></p> <p>pinMask GPIO pin mask for a set of pins</p>
Return Value	Uint32 Returns the value read on the pins for the pinMask
Description	This function reads data from a set of pins passed on as a pinmask to the function. See also <code>GPIO_write()</code> , <code>GPIO_pinWrite()</code> and <code>GPIO_pinRead()</code> .
Example	<pre>pinVal = GPIO_read(hGpio,GPIO_PIN8 GPIO_PIN7 GPIO_PIN6);</pre>

GPIO_SUPPORT

Compile-time constant

Constant	GPIO_SUPPORT
Description	Compile-time constant that has a value of 1 if the device supports the GPIO module and 0 otherwise. You are not required to use this constant. Note: The GPIO module is not supported on devices without the GPIO peripheral.
Example	<pre>#if (GPIO_SUPPORT) /* user GPIO configuration / #endif</pre>

GPIO_write

Writes the value to the specified set of GPIO pins

Function	<pre>void GPIO_write(GPIO_Handle hGpio, Uint32 pinMask, Uint32 val);</pre>
Arguments	<p>hGpio Handle to GPIO device, see <code>GPIO_open()</code></p> <p>pinMask GPIO pin mask</p> <p>val bit value</p>
Return Value	none
Description	This function writes the value to a set of GPIO pins. See also <code>GPIO_read()</code> .
Example	<pre>GPIO_write(hGpio,GPIO_PIN2 GPIO_PIN3,0x4);</pre>

HPI Module

This chapter describes the HPI module, lists the API functions and macros within the module, and provides an HPI API reference section.

Topic	Page
12.1 Overview	12-2
12.2 Macros	12-3
12.3 Functions	12-5

12.1 Overview

The HPI module has a simple API for configuring the HPI registers. Functions are provided for reading HPI status bits and setting interrupt events. For C64x™ devices, write and Read memory addresses can be accessed.

Table 12–1 shows the API functions within the HPI module.

Table 12–1. HPI APIs

Syntax	Type	Description	See page ...
HPI_getDspint	F	Reads the DSPINT bit from the HPIC register	12-5
HPI_getEventId	F	Obtain the IRQ event associated with the HPI device	12-5
HPI_getFetch	F	Reads the FETCH flag from the HPIC register and returns its value.	12-5
HPI_getHint	F	Returns the value of the HINT bit of the HPIC register	12-6
HPI_getHrdy	F	Returns the value of the HRDY bit of the HPIC register	12-6
HPI_getHwob	F	Returns the value of the HWOB bit of the HPIC register	12-6
HPI_getReadAddr	F	Returns the Read memory address (HPIAR C64x only)	12-6
HPI_getWriteAddr	F	Returns the Write memory address (HPIAW C64x only)	12-7
HPI_setDspint	F	Writes the value to the DSPINT field of the HPIC register	12-7
HPI_setHint	F	Writes the value to the HINT field of the HPIC register	12-7
HPI_setReadAddr	F	Sets the Read memory address (HPIAR C64x only)	12-8
HPI_setWriteAddr	F	Sets the Write memory address (HPIAW C64x only)	12-8
HPI_SUPPORT	C	A compile-time constant whose value is 1 if the device supports the HPI module	12-8

Note: F = Function; C = Constant

12.2 Macros

There are two types of HPI macros: those that access registers and fields, and those that construct register and field values.

Table 12–2 lists the HPI macros that access registers and fields, and Table 12–3 lists the HPI macros that construct register and field values. The macros themselves are found in Chapter 28, *Using the HAL Macros*.

HPI macros are not handle-based.

Table 12–2. HPI Macros that Access Registers and Fields

Macro	Description/Purpose	See page ...
HPI_ADDR(<REG>)	Register address	28-12
HPI_RGET(<REG>)	Returns the value in the peripheral register	28-18
HPI_RSET(<REG>,x)	Register set	28-20
HPI_FGET(<REG>,<FIELD>)	Returns the value of the specified field in the peripheral register	28-13
HPI_FSET(<REG>,<FIELD>,fieldval)	Writes <i>fieldval</i> to the specified field in the peripheral register	28-15
HPI_FSETS(<REG>,<FIELD>,<SYM>)	Writes the symbol value to the specified field in the peripheral	28-17
HPI_RGETA(addr,<REG>)	Gets register for a given address	28-19
HPI_RSETA(addr,<REG>,x)	Sets register for a given address	28-20
HPI_FGETA(addr,<REG>,<FIELD>)	Gets field for a given address	28-13
HPI_FSETA(addr,<REG>,<FIELD>,fieldval)	Sets field for a given address	28-16
HPI_FSETSA(addr,<REG>,<FIELD>,<SYM>)	Sets field symbolically for a given address	28-17

Table 12–3. HPI Macros that Construct Register and Field Values

Macro	Description/Purpose	See page ...
HPI_<REG>_DEFAULT	Register default value	28-21
HPI_<REG>_RMK()	Register make	28-23
HPI_<REG>_OF()	Register value of ...	28-22
HPI_<REG>_<FIELD>_DEFAULT	Field default value	28-24
HPI_FMK()	Field make	28-14
HPI_FMKS()	Field make symbolically	28-15
HPI_<REG>_<FIELD>_OF()	Field value of ...	28-24
HPI_<REG>_<FIELD>_<SYM>	Field symbolic value	28-24

12.3 Functions

HPI_getDspint *Reads DSPINT bit from HPIC register*

Function	Uint32 HPI_getDspint();
Arguments	none
Return Value	DSPINT Returns the value of the DSPINT bit, 0 or 1
Description	This function reads the DSPINT bit from the HPIC register.
Example	<pre>if (HPI_getDspint()) { }</pre>

HPI_getEventId *Obtains IRQ event associated with HPI device*

Function	Uint32 HPI_getEventId();
Arguments	none
Return Value	Event ID Returns the IRQ event for the HPI device
Description	Use this function to obtain the IRQ event associated with the HPI device. Currently this is IRQ_EVT_DSPINT.
Example	<pre>HpiEventId = HPI_getEventId();</pre>

HPI_getFetch *Reads FETCH flag from HPIC register and returns its value*

Function	Uint32 HPI_getFetch();
Arguments	none
Return Value	FETCH Returns the value 0 (always read at 0)
Description	This function reads the FETCH flag from the HPIC register and returns its value.
Example	<pre>flag = HPI_getFetch();</pre>

HPI_getHint

HPI_getHint *Returns value of HINT bit of HPIC register*

Function	Uint32 HPI_getHint();
Arguments	none
Return Value	HINT Returns the value of the HINT bit, 0 or 1
Description	This function returns the value of the HINT bit of the HPIC register.
Example	<pre>hint = HPI_getHint();</pre>

HPI_getHrdy *Returns value of HRDY bit of HPIC register*

Function	Uint32 HPI_getHrdy();
Arguments	none
Return Value	HRDY Returns the value of the HRDY bit, 0 or 1
Description	This function returns the value of the HRDY bit of the HPIC register.
Example	<pre>hrdy = HPI_getHrdy();</pre>

HPI_getHwob *Returns value of HWOB bit of HPIC register*

Function	Uint32 HPI_getHwob();
Arguments	none
Return Value	HWOB Returns the value of the HWOB bit, 0 or 1
Description	This function returns the value of the HWOB bit of the HPIC register.
Example	<pre>hwob = HPI_getHwob();</pre>

HPI_getReadAddr *Returns the Read memory address (HPIAR C64x devices only)*

Function	Uint32 HPI_getReadAddr();
Arguments	none
Return Value	HPIAR Read Memory Address
Description	This function returns the read memory address set under the HPIAR register (supported by C64x devices only)
Example	<pre>Uint32 addR; addR = HPI_getReadAddr();</pre>

HPI_getWriteAddr *Returns the Write memory address (HPIAW C64x devices only)*

Function	Uint32 HPI_getWriteAddr();
Arguments	none
Return Value	HPIAW Write Memory Address
Description	This function returns the write memory address set under the HPIAW register (supported by C64x devices only)
Example	<pre>Uint32 addW; addW = HPI_getWriteAddr();</pre>

HPI_setDspint *Writes value to DSPINT field of HPIC register*

Function	void HPI_setDspint(Uint32 Val);
Arguments	Val Value to write to DSPINT: 1 (writing 0 has no effect)
Return Value	none
Description	This function writes the value to the DSPINT file of the HPIC register
Example	<pre>HPI_setDspint(0); HPI_setDspint(1);</pre>

HPI_setHint *Writes value to HINT field of HPIC register*

Function	void HPI_setHint(Uint32 Val);
Arguments	Val Value to write to HINT: 0 or 1
Return Value	none
Description	This function writes the value to the HINT file of the HPIC register
Example	<pre>HPI_setHint(0); HPI_setHint(1);</pre>

HPI_setReadAddr

HPI_setReadAddr *Sets the Read memory address (HPIAR C64x devices only)*

Function	<pre>void HPI_setReadAddr(Uint32 address;);</pre>
Arguments	address Read Memory Address to be set
Return Value	none
Description	This function sets the read memory address in the HPIAR register (supported by C64x devices only)
Example	<pre>Uint32 addR = 0x80000400; HPI_setReadAddr(addR);</pre>

HPI_setWriteAddr *Sets the Write memory address (HPIAW C64x devices only)*

Function	<pre>void HPI_setWriteAddr(Uint32 address;);</pre>
Arguments	address Write Memory Address to be set
Return Value	none
Description	This function sets the write memory address in the HPIAW register (supported by C64x devices only)
Example	<pre>Uint32 addW = 0x80000000; HPI_setWriteAddr(addW);</pre>

HPI_SUPPORT *Compile-time constant*

Constant	HPI_SUPPORT
Description	Compile time constant that has a value of 1 if the device supports the HPI module and 0 otherwise. You are not required to use this constant.
Example	<pre>#if (HPI_SUPPORT) /* user HPI configuration / #endif</pre>

I2C Module

This chapter describes the I2C module, lists the API functions and macros within the module, and provides an I2C API reference section.

Topic	Page
13.1 Overview	13-2
13.2 Macros	13-5
13.3 Configuration Structure	13-7
13.4 Functions	13-8

13.1 Overview

The inter-integrated circuit (I2C) module provides an interface between a TMS320c6000 DSP and other devices compliant with Phillips Semiconductors Inter-IC bus (I2C-bus) Specification version 2.1 and connected by way of an I2C-bus.

Refer to *TMS320c6000 DSP Inter-Integrated Circuit (I2C) Module Reference Guide* (SPRU175) for more details.

Table 13–1 lists the configuration structure for use with the I2C functions.

Table 13–2 lists the functions and constants available in the CSL I2C module.

Table 13–1. I2C Configuration Structures

Structure	Purpose	See page ...
I2C_Config	Structure used to configure an I2C interface	13-7

Table 13–2. I2C APIs

(a) Primary I2C Functions

Syntax	Type	Description	See page ...
I2C_close	F	Closes a previously opened I2C device	13-8
I2C_config	F	Configures an I2C using the configuration structure	13-8
I2C_configArgs	F	Configures an I2C using register values	13-9
I2C_open	F	Opens an I2C device for use	13-10
I2C_reset	F	Resets an I2C device	13-11
I2C_resetAll	F	Resets all I2C device registers	13-12
I2C_sendStop	F	Generates a stop condition	13-12
I2C_start	F	Generates a start condition	13-13

(b) Secondary I2C Functions and Constants

Syntax	Type	Description	See page ...
I2C_bb	F	Returns the bus-busy status	13-13
I2C_getConfig	F	Reads the current I2C configuration values	13-14
I2C_getEventId	F	Obtains the event ID for the specified I2C devices	13-14
I2C_getRcvAddr	F	Returns the data receive register address	13-15

Table 13–2. I2C APIs

Syntax	Type	Description	See page ...
I2C_getXmtAddr	F	Returns the data transmit register address	13-15
I2C_getPins [†]	F	Returns value of I2CPDIN register	13-23
I2C_setPins [†]	F	Sets value of I2CPDSET register	13-23
I2C_clearPins [†]	F	Sets value of I2CPDCLR register	13-24
I2C_getExtMode [†]	F	Returns status of transmit data receive ready mode	13-24
I2C_setMstAck [†]	F	Sets the transmit data receive ready mode to MSTACK	13-25
I2C_setDxrCpy [†]	F	Sets the transmit data receive ready mode to DXRCOPY	13-25
I2C_intClear	F	Clears the highest priority interrupt flag	13-16
I2C_intClearAll	F	Clears all interrupt flags	13-16
I2C_intEvtDisable	F	Disables the specified I2C interrupt	13-17
I2C_intEvtEnable	F	Enables the specified I2C interrupt	13-18
I2C_OPEN_RESET	C	I2C reset flag, used while opening	13-18
I2C_outOfReset	F	De-asserts the I2C device from reset	13-19
I2C_readByte	F	Performs an 8-bit data read	13-19
I2C_rfull	F	Returns the overrun status of the receiver	13-20
I2C_rrdy	F	Returns the receive data ready interrupt flag value	13-20
I2C_SUPPORT	C	Compile time constant whose value is 1 if the device supports the I2C module	13-19
I2C_writeByte	F	Writes an 8-bit value to the I2C data transmit register	13-21
I2C_xempty	F	Returns the transmitter underflow status	13-21
I2C_xrdy	F	Returns the data transmit ready status	13-22

Note: F = Function; C = Constant;

[†] Only in C6410, C6413, and C6418 devices.

13.1.1 Using an I2C Device

To use an I2C device, the user must first open it and obtain a device handle using `I2C_open()`. Once opened, the device handle is used to call the other APIs.

The I2C device can be configured by passing an `I2C_Config` structure to `I2C_config()` or by passing register values to the `I2C_configArgs()` function. To assist in creating register values, the `_RMK(make)` macros construct register values based on field values. In addition, the symbol constants may be used for the field values.

Once the I2C is used and is no longer needed, it should be closed by passing the corresponding handle to `I2C_close()`.

13.2 Macros

There are two types of I2C macros: those that access registers and fields, and those that construct register and field values.

Table 13–3 lists the I2C macros that access registers and fields, and Table 13–4 lists the I2C macros that construct register and field values. The macros themselves are found in Chapter 28, *Using the HAL Macros*.

I2C macros are handle-based.

Table 13–3. I2C Macros that Access Registers and Fields

Macro	Description/Purpose	See page ...
I2C_ADDR(<REG>)	Register address	28-12
I2C_RGET(<REG>)	Returns the value in the peripheral register	28-18
I2C_RSET(<REG>,x)	Register set	28-20
I2C_FGET(<REG>,<FIELD>)	Returns the value of the specified field in the peripheral register	28-13
I2C_FSET(<REG>,<FIELD>,fieldval)	Writes <i>fieldval</i> to the specified field in the peripheral register	28-15
I2C_FSETS(<REG>,<FIELD>,<SYM>)	Writes the symbol value to the specified field in the peripheral	28-17
I2C_RGETA(addr,<REG>)	Gets register for a given address	28-19
I2C_RSETA(addr,<REG>,x)	Sets register for a given address	28-20
I2C_FGETA(addr,<REG>,<FIELD>)	Gets field for a given address	28-13
I2C_FSETA(addr,<REG>,<FIELD>,fieldval)	Sets field for a given address	28-16
I2C_FSETSA(addr,<REG>,<FIELD>,<SYM>)	Sets field symbolically for a given address	28-17
I2C_ADDRH(h,<REG>)	Returns the address of a memory-mapped register for a given handle	28-12
I2C_RGETH(h,<REG>)	Returns the value of a register for a given handle	28-19
I2C_RSETH(h,<REG>,x)	Sets the register value to x for a given handle	28-21
I2C_FGETH(h,<REG>,<FIELD>)	Returns the value of the field for a given handle	28-14
I2C_FSETH(h,<REG>,<FIELD>, fieldval)	Sets the field value to x for a given handle	28-16

Table 13–4. I2C Macros that Construct Register and Field Values

Macro	Description/Purpose	See page...
I2C_<REG>_DEFAULT	Register default value	28-21
I2C_<REG>_RMK()	Register make	28-23
I2C_<REG>_OF()	Register value of ...	28-22
I2C_<REG>_<FIELD>_DEFAULT	Field default value	28-24
I2C_FMK()	Field make	28-14
I2C_FMKS()	Field make symbolically	28-15
I2C_<REG>_<FIELD>_OF()	Field value of ...	28-24
I2C_<REG>_<FIELD>_<SYM>	Field symbolic value	28-24

13.3 Configuration Structure

I2C_Config *Structure used to configure an I2C interface*

Structure	I2C_Config;	
Members	Uint32 i2coar Uint32 i2cimr Uint32 i2cckl Uint32 i2cckh Uint32 i2ccnt Uint32 i2csar Uint32 i2cmdr Uint32 i2cpsc Uint32 i2cemdr [†] Uint32 i2cpfunc [†] Uint32 i2cpdir [†]	Own address register Interrupt mask register Clock control low register Clock control high register Data count register Slave address register Mode register Prescalar register Extended mode register Pin function register Pin direction register
	[†] Additional configuration entries for C6410, C6413, and C6418 devices.	
Description	This is the configuration structure used to dynamically configure the I2C device. The user should create and initialize this structure before passing its address to the <code>I2C_config()</code> function.	

I2C_close

13.4 Functions

13.4.1 Primary Functions

I2C_close *Closes a previously opened I2C device*

Function	<pre>void I2C_close(I2C_Handle hI2c);</pre>
Arguments	hI2c Device handle; see I2C_open()
Return Value	none
Description	This function closes a previously opened I2C device. The following tasks are performed: 1) The I2C event is disabled and cleared. 2) The I2C registers are set to their default values
Example	<pre>I2C_Handle hI2c; ... I2C_close(hI2c);</pre>

I2C_config *Configures I2C using the configuration structure*

Function	<pre>void I2C_config(I2C_Handle hI2c, I2C_Config *myConfig);</pre>
Arguments	hI2c Device handle; see I2C_open() myConfig Pointer to an initialized configuration structure
Return Value	none
Description	This function configures the I2C device using the configuration structure which contains members corresponding to each of the I2C registers. These values are directly written to the corresponding I2C device registers.
Example	<pre>I2C_Handle hI2c I2C_Config myConfig ... I2C_config(hI2c, &myConfig);</pre>

I2C_configArgs *Configures I2C using register values*

For C6410, C6413, and C6418

Function

```
void I2C_configArgs(
    I2C_Handle hI2c
    Uint32     i2coar,
    Uint32     i2cimr,
    Uint32     i2cckl,
    Uint32     i2cckh,
    Uint32     i2ccnt,
    Uint32     i2csar,
    Uint32     i2cmdr,
    Uint32     i2cpsc
    Uint32     icemdr
    Uint32     i2cpfunc
    Uint32     i2cpdir
);
```

Arguments

hI2c	Device handle; see I2C_open()
i2coar	Own address register
i2cimr	Interrupt mask register
i2cckl	Clock control low register
i2cckh	Clock control high register
i2ccnt	Data count register
i2csar	Slave address register
i2cmdr	Mode register
i2cpsc	Prescalar register
i2cemdr	Extended mode register
i2cpfunc	Pin function register
i2cpdir	Pin direction register

Return Value

none

Description

This function configures the I2C module using the register values passed in as arguments.

Example

```
I2C_Handle hI2c;
...
IRQ_configArgs (hI2c, 0x10, 0x00, 0x08, 0x10, 0x05, 0x10, 0x6E0, 0x19,
0x1, 0x2);
```

I2C_open

For other devices

Function

```
void I2C_configArgs(  
    I2C_Handle hI2c  
    Uint32     i2coar,  
    Uint32     i2cimr,  
    Uint32     i2cclkL,  
    Uint32     i2cclkH,  
    Uint32     i2ccnt,  
    Uint32     i2csar,  
    Uint32     i2cmdr,  
    Uint32     i2cpsc  
);
```

Arguments

hI2c	Device handle; see I2C_open()
i2coar	Own address register
i2cimr	Interrupt mask register
i2cclkL	Clock control low register
i2cclkH	Clock control high register
i2ccnt	Data count register
i2csar	Slave address register
i2cmdr	Mode register
i2cpsc	Prescalar register

Return Value

none

Description

This function configures the I2C module using the register values passed in as arguments.

Example

```
I2C_Handle hI2c;  
...  
IRQ_configArgs(hI2c, 0x10, 0x00, 0x08, 0x10, 0x05, 0x10, 0x6E0, 0x19);
```

I2C_open

Opens and I2C device for use

Function

```
I2C_Handle I2C_open(  
    Uint16 devNum  
    Uint16 flags  
);
```

Arguments

devNum	Specifies the device to be opened
flags	Open flags
	<input type="checkbox"/> I2C_OPEN_RESET: resets the I2C

Return Value	I2C_Handle Device handle INV: open failed
Description	Before the I2C device can be used, it must be opened using this function. Once opened, it cannot be opened again until it is closed. (See I2C_close().) The return value is a unique device handle that is used in subsequent I2C API calls. If the open fails, 'INV' is returned.
Example	<pre>I2C_Handle hI2c; ... hI2c = I2C_open(OPEN_RESET);</pre>

I2C_reset *Resets an I2C device*

Function	<pre>void I2C_reset(I2C_Handle hI2c);</pre>
Arguments	hI2c Device handle; see I2C_open()
Return Value	none
Description	This function resets the I2C device specified by the handle.
Example	<pre>I2C_Handle hI2c; ... I2C_reset(hI2c);</pre>

I2C_resetAll

I2C_resetAll *Resets all I2C device registers*

Function	<code>void I2C_resetAll(void);</code>
Arguments	none
Return Value	none
Description	This function resets all I2C device registers.
Example	<code>I2C_resetAll();</code>

I2C_sendStop *Generates a stop condition*

Function	<code>void I2C_sendStop(I2C_Handle hI2c);</code>
Arguments	<code>hI2c</code> Device handle; see <code>I2C_open()</code>
Return Value	none
Description	This function sets the STP bit in the I2CMR register, which generates stop conditions.
Example	<code>I2C_Handle hI2c; ... I2C_sendStop(hI2c);</code>

I2C_start *Generates a start condition*

Function	void I2C_start(I2C_Handle hI2c);
Arguments	hI2c Device handle; see I2C_open ()
Return Value	none
Description	This function sets the STP bit in the I2CMDR register, which generates data transmission/reception start condition. It is reset to '0' by the hardware after the start condition has been generated.
Example	<pre>I2C_Handle hI2c; ... I2C_start(hI2c);</pre>

13.4.2 Auxiliary Functions and Constants**I2C_bb** *Returns the bus-busy status*

Function	Uint32 I2C_bb(I2C_Handle hI2c);
Arguments	hI2c Device handle; see I2C_open ()
Return Value	Uint32 bus status <input type="checkbox"/> 0 – free <input type="checkbox"/> 1 – busy
Description	This function returns the state of the serial bus.
Example	<pre>I2C_Handle hI2c; ... if(I2C_bb(hI2c)) { ... ; }</pre>

I2C_getConfig

I2C_getConfig *Reads the current I2C configuration values*

Function	<pre>void I2C_getConfig(I2C_Handle hI2c, I2C_Config *myConfig);</pre>
Arguments	<p>hI2c Device handle; see I2C_open()</p> <p>myConfig Pointer to the configuration structure</p>
Return Value	none
Description	This function gets the current I2C configuration values.
Example	<pre>I2C_Handle hI2c; I2C_Config i2cCfg; ... I2C_getConfig(hI2c, &i2cCfg);</pre>

I2C_getEventId *Obtains the event ID for the specified I2C device*

Function	<pre>Uint32 I2C_getEventId(I2C_Handle hI2c);</pre>
Arguments	hI2c Device handle; see I2C_open()
Return Value	Uint32 Event ID
Description	This function returns the event ID of the interrupt associated with the I2C device.
Example	<pre>I2C_Handle hI2c; Uint16 evt; ... evt = I2C_getEventId(hI2c); IRQ_enable(evt);</pre>

I2C_getRcvAddr *Returns data receive register address*

Function `Uint32 I2C_getRcvAddr(
 I2C_Handle hI2c
);`

Arguments `hI2c` Device handle; see `I2C_open()`

Return Value `Uint32` Data receive register address

Description This function returns the data receive register address.

Example `I2C_Handle hI2c;
 Uint32 val;
 ...
 val = I2C_getRcvAddr(hI2c);`

I2C_getXmtAddr *Returns the data transmit register address*

Function `Uint32 I2C_getXmtAddr(
 I2C_Handle hI2c
);`

Arguments `hI2c` Device handle; see `I2C_open()`

Return Value `Uint32` Data transmit register address

Description This function returns the data transmit register address.

Example `I2C_Handle hI2c;
 Uint32 val;
 ...
 val = I2C_getXmtAddr(hI2c);`

I2C_intClear

I2C_intClear *Clears the highest priority interrupt flag*

Function	Uint32 I2C_intClear(I2C_Handle hI2c);
Arguments	hI2c Device handle; see I2C_open()
Return Value	Uint32 Interrupt vector register content
Description	This function clears the interrupt flag. If there is more than one interrupt flag, it clears the highest priority flag and returns the content of the interrupt vector register (I2CIVR).
Example	<pre>I2C_Handle hI2c; Uint32 val; ... val = I2C_intClear(hI2c);</pre>

I2C_intClearAll *Clears all interrupt flags*

Function	void I2C_intClearAll(I2C_Handle hI2c);
Arguments	hI2c Device handle; see I2C_open()
Return Value	none
Description	This function clears all the interrupt flags.
Example	<pre>I2C_Handle hI2c; Uint32 val; ... val = I2C_intClearAll(hI2c);</pre>

I2C_intEvtDisable *Disables the specified I2C interrupt*

Function	<pre>void I2C_intEvtDisable(I2C_Handle hI2c, Uint32 maskFlag);</pre>
Arguments	<pre>hI2c Device handle; see I2C_open() maskFlag Interrupt mask</pre>
Return Value	none
Description	<p>This function disables the I2C interrupt specified by the maskFlag.</p> <p>maskFlag can be an OR-ed combination of one or more of the following:</p> <ul style="list-style-type: none">I2C_EVT_AL - Arbitration Lost Interrupt EnableI2C_EVT_NACK - No Acknowledgement Interrupt EnableI2C_EVT_ARDY - Register Access Ready InterruptI2C_EVT_RRDY - Data Receive Ready InterruptI2C_EVT_XRDY - Data Transmit Ready Interrupt
Example	<pre>I2C_Handle hI2c; Uint32 maskFlag = I2C_EVT_AL I2C_EVT_RRDY; ... I2C_intEvtDisable(hI2c, maskFlag);</pre>

I2C_intEvtEnable

I2C_intEvtEnable *Enables the specified I2C interrupt*

Function	<pre>void I2C_intEvtEnable(I2C_Handle hI2c, Uint32 maskFlag);</pre>
Arguments	<pre>hI2c Device handle; see I2C_open() maskFlag Interrupt mask</pre>
Return Value	none
Description	<p>This function enables the I2C interrupt specified by the maskFlag.</p> <p>maskFlag can be an OR-ed combination of one or more of the following:</p> <ul style="list-style-type: none">I2C_EVT_AL - Arbitration Lost Interrupt EnableI2C_EVT_NACK - No Acknowledgement Interrupt EnableI2C_EVT_ARDY - Register Access Ready InterruptI2C_EVT_RRDY - Data Receive Ready InterruptI2C_EVT_XRDY - Data Transmit Ready Interrupt
Example	<pre>I2C_Handle hI2c; Uint32 maskFlag = I2C_EVT_AL I2C_EVT_RRDY; ... I2C_intEvtEnable(hI2c, maskFlag);</pre>

I2C_OPEN_RESET *I2C reset flag, used while opening*

Constant	I2C_OPEN_RESET
Description	This flag is used while opening and I2C device. To open with reset, use I2C_OPEN_RESET. Otherwise, use 0.
Example	See I2C_open()

I2C_outOfReset	<i>De-asserts the I2C device from reset</i>
Function	<pre>void I2C_outOfReset(I2C_Handle hI2c);</pre>
Arguments	hI2c Device handle; see I2C_open()
Return Value	none
Description	I2C comes out out reset by setting the IRS field of the I2CMRDR register.
Example	<pre>I2C_Handle hI2c; ... I2C_outOfReset(hI2c);</pre>
I2C_SUPPORT	<i>Compile time constant</i>
Constant	I2C_SUPPORT
Description	Compile time constant that has a value of 1 if the device supports the I2C module and 0 otherwise. You are not required to use this constant. Currently, only the C6713 device supports this module.
Example	<pre>#if (I2C_SUPPORT) /* user I2C configuration */ #endif</pre>
I2C_readByte	<i>Performs an 8-bit data read</i>
Function	<pre>Uint8 I2C_readByte(I2C_Handle hI2c);</pre>
Arguments	hI2c Device handle; see I2C_open()
Return Value	Uint8 Received data
Description	This function performs a direct 8-bit read from the data receive register (I2CDRR). This function does not check the receive ready status. To check the receive ready status, use I2C_rrdy().
Example	<pre>I2C_Handle hI2c; Uint8 data; ... data = I2C_readByte(hI2c);</pre>

I2C_rfull

I2C_rfull

Returns the overrun status of the receiver

Function	Uin32 I2C_rfull(I2C_Handle hI2c);
Arguments	hI2c Device handle; see I2C_open()
Return Value	Uin32 Overrun status <input type="checkbox"/> 0 – Normal <input type="checkbox"/> 1 – Overrun
Description	This function returns the overrun status of the receive shift register. This field is cleared by reading the data receive register or resetting the I2C.
Example	<pre>I2C_Handle hI2c; ... if(I2C_rfull(hI2c)){ ... }</pre>

I2C_rrdy

Returns the receive data ready interrupt flag value

Function	Uin32 I2C_rrdy(I2C_Handle hI2c);
Arguments	hI2c Device handle; see I2C_open()
Return Value	Uin32 Interrupt flag value <input type="checkbox"/> 0 – Receive Data Not Ready <input type="checkbox"/> 1 – Receive Data Ready
Description	This function returns the receive data ready interrupt flag value. The bit is cleared to '0' when I2CDRR is read.
Example	<pre>I2C_Handle hI2c; ... if(I2C_rrdy(hI2c)){ ... }</pre>

I2C_writeByte *Writes an 8-bit value to the I2C data transmit register*

Function	<pre>void I2C_writeByte(I2C_Handle hI2c, Uint8 val);</pre>
Arguments	<p>hI2c Device handle; see I2C_open()</p> <p>val 8-bit data to send</p>
Return Value	none
Description	This function writes an 8-bit value to the I2C data transmit register. This function does not check the transfer ready status. To check the transfer ready status, use I2C_xrdy().
Example	<pre>I2C_Handle hI2c; ... I2C_writeByte(hI2c, 0x34);</pre>

I2C_xempty *Returns the transmitter underflow status*

Function	<pre>Uint32 I2C_xempty(I2C_Handle hI2c);</pre>
Arguments	hI2c Device handle; see I2C_open()
Return Value	Uint32 Underflow status □ 0 – Underflow
Description	This function returns the transmitter underflow status. The value is '0' when underflow occurs.
Example	<pre>I2C_Handle hI2c; ... if(I2C_xempty(hI2c)) { ... }</pre>

I2C_xrdy

I2C_xrdy

Returns the data transmit ready status

Function	Uin32 I2C_xrdy(I2C_Handle hl2c);
Arguments	hl2c Device handle; see I2C_open()
Return Value	Uin32 Interrupt flag value <input type="checkbox"/> 0 – Transmit Data Not Ready <input type="checkbox"/> 1 – Transmit Data Ready
Description	This function returns the transmit data ready interrupt flag value.
Example	<pre>I2C_Handle hI2c; ... if(I2C_xrdy(hI2c)) { ... }</pre>

13.4.3 Auxiliary Functions Defined for C6410, C6413 and C6418

The SDA and SCL pins of the I2C can be used for GPIO. To use the GPIO mode of the I2C pins:

- Place the I2C in reset by setting IRS = '0' in I2CMDR.
- Enable GPIO mode by setting GPMODE = '1' in I2CPFUNC.

Some DSPs may require pullups on the SDA and SCL pins in order to use GPIO mode. Please refer to the device specific data manual to determine if this is the case for the DSP being used.

I2C_getPins *Returns value of I2CPDIN register*

Function	<pre>Uint32 I2C_getPins(I2C_Handle hI2C);</pre>
Return Value	Uint32 Value of I2CPDIN register
Description	Indicates the logic level present on the SDA and SCL pins. If a value of 0 is read for SDAIN, it indicates that the logic level corresponding to LOW is present on the SDA pin. A value of 1 indicates that the logic level corresponding to HIGH is present on the SDA pin. The SCLIN similarly indicates the status of the SCL pin.
Example	<pre>I2C_Handle hI2C; Uint32 pinStatus; ... pinStatus = I2C_getPins(hI2C);</pre>

I2C_setPins *Sets value of SDA and SCL pins when they are configured as output*

Function	<pre>void I2C_setPins(I2C_Handle hI2C, Uint32 pins);</pre>
Return Value	None
Description	This bit sets the value of the I2CPDOUT by setting the SDAOUT and SCLOUT bits of the I2CPDSET register. A write of 0 has no effect. When 1 is written to either of these bits, the corresponding bit in I2COUT is set to 1. This drives the SDA and SCL pins HIGH.
Example	<pre>I2C_Handle hI2C; ... I2C_setPins(hI2C,0x3);</pre>

I2C_clearPins

I2C_clearPins

Clears the value of SDA and SCL pins where they are configured as output

Function	<pre>void I2C_clearPins(I2C_Handle hI2C, Uint32 pins);</pre>
Return Value	None
Description	This bit sets the value of the I2CPDOUT by setting the SDAOUT and SCLOUT bits of the I2CPDCLR register. A write of 0 has no effect. When 1 is written to either of these bits, the corresponding bit in I2COUT is cleared to 0. This drives the SDA and SCL pins LOW.
Example	<pre>I2C_Handle hI2C; ... I2C_clearPins(hI2C,0x3);</pre>

I2C_getExtMode

Returns status of transmit data receive ready mode

Function	<pre>Uint32 I2C_getExtMode(I2C_Handle hI2C);</pre>
Return Value	Uint32 Returns status of transmit data receive ready mode.
Description	The XRDYM bit of the I2CEMDR register determines which condition generates a transmit-data-receive interrupt. This has an effect only when the I2C is operating as a slave-transmitter. A value of 0 indicates that the transmit-data-ready interrupt is generated when the master requests more data by sending an acknowledge signal after the transmission of the last data.
Example	<pre>I2C_Handle hI2C; Uint32 emdrStat; ... emdrStat = I2C_getExtMode(hI2C);</pre>

I2C_setMstAck *Sets the transmit data receive ready mode to MSTACK*

Function	<pre>void I2C_setMstAck(I2C_Handle hI2C;);</pre>
Return Value	None
Description	The XRDYM bit of the I2CEMDR register determines which condition generates a transmit-data-receive interrupt. This has an effect only when the I2C is operating as a slave-transmitter. This function sets the transmit-data-ready interrupt to be generated when the master requests more data by sending an acknowledge signal after the transmission of the last data.

I2C_setDxrCpy *Sets the transmit data receive ready mode to MSTACK*

Function	<pre>void I2C_setDxrCpy(I2C_Handle hI2C;);</pre>
Return Value	None
Description	The XRDYM bit of the I2CEMDR register determines which condition generates a transmit-data-receive interrupt. This has an effect only when the I2C is operating as a slave-transmitter. This function sets the transmit-data-ready interrupt to be generated when the data in I2CDXR is copied to the I2CXSR.

IRQ Module

This chapter describes the IRQ module, lists the API functions and macros within the module, and provides an IRQ API reference section.

Topic	Page
14.1 Overview	14-2
14.2 Macros	14-4
14.3 Configuration Structure	14-6
14.4 Functions	14-9

14.1 Overview

The IRQ module is used to manage CPU interrupts.

Table 14–1 lists the configuration structure for use with the IRQ functions.

Table 14–2 lists the functions and constants available in the CSL IRQ module.

Table 14–1. IRQ Configuration Structure

Structure	Purpose	See page ...
IRQ_Config	Interrupt dispatcher configuration structure	14-6

Table 14–2. IRQ APIs

(a) Primary IRQ Functions

Syntax	Type	Description	See page ...
IRQ_clear	F	Clears the event flag from the IFR register	14-9
IRQ_config	F	Dynamically configures an entry in the interrupt dispatcher table	14-9
IRQ_configArgs	F	Dynamically configures an entry in the interrupt dispatcher table	14-10
IRQ_disable	F	Disables the specified event	14-11
IRQ_enable	F	Enables the specified event	14-11
IRQ_globalDisable	F	Globally disables interrupts	14-12
IRQ_globalEnable	F	Globally enables interrupts	14-12
IRQ_globalRestore	F	Restores the global interrupt enable state	14-12
IRQ_reset	F	Resets an event by disabling and then clearing it	14-13
IRQ_restore	F	Restores an event enable state	14-13
IRQ_setVecs	F	Sets the base address of the interrupt vectors	14-14
IRQ_test	F	Allows testing of an event to see if its flag is set in the IFR register	14-14

Table 14–2. IRQ APIs (Continued)

Syntax	Type	Description	See page ...
<i>(b) Auxiliary IRQ Functions</i>			
IRQ_EVT_NNNN	C	These are the IRQ events	14-15
IRQ_getArg	F	Reads the user-defined interrupt service routine argument	14-17
IRQ_getConfig	F	Returns the current IRQ set-up using configuration structure	14-18
IRQ_map	F	Maps an event to a physical interrupt number by configuring the interrupt selector MUX registers	14-19
IRQ_nmiDisable	F	Disables the nmi interrupt event	14-19
IRQ_nmiEnable	F	Enables the nmi interrupt event	14-19
IRQ_resetAll	F	Resets all interrupt events by setting the GIE bit to 0 and then disabling and clearing them	14-20
IRQ_set	F	Sets specified event by writing to appropriate ISR register	14-20
IRQ_setArg	F	Sets the user-defined interrupt service routine argument	14-21
IRQ_SUPPORT	C	A compile time constant whose value is 1 if the device supports the IRQ module	14-21

Note: F = Function; C = Constant;

14.2 Macros

There are two types of IRQ macros: those that access registers and fields, and those that construct register and field values.

Table 14–3 lists the IRQ macros that access registers and fields, and Table 14–4 lists the IRQ macros that construct register and field values. The macros themselves are found in Chapter 28, *Using the HAL Macros*.

IRQ macros are not handle-based.

Table 14–3. IRQ Macros that Access Registers and Fields

Macro	Description/Purpose	See page ...
IRQ_ADDR(<REG>)	Register address	28-12
IRQ_RGET(<REG>)	Returns the value in the peripheral register	28-18
IRQ_RSET(<REG>,x)	Register set	28-20
IRQ_FGET(<REG>,<FIELD>)	Returns the value of the specified field in the peripheral register	28-13
IRQ_FSET(<REG>,<FIELD>,fieldval)	Writes <i>fieldval</i> to the specified field in the peripheral register	28-15
IRQ_FSETS(<REG>,<FIELD>,<SYM>)	Writes the symbol value to the specified field in the peripheral	28-17
IRQ_RGETA(addr,<REG>)	Gets register for a given address	28-19
IRQ_RSETA(addr,<REG>,x)	Sets register for a given address	28-20
IRQ_FGETA(addr,<REG>,<FIELD>)	Gets field for a given address	28-13
IRQ_FSETA(addr,<REG>,<FIELD>, fieldval)	Sets field for a given address	28-16
IRQ_FSETSA(addr,<REG>,<FIELD>, <SYM>)	Sets field symbolically for a given address	28-17

Table 14–4. *IRQ Macros that Construct Register and Field Values*

Macro	Description/Purpose	See page...
IRQ_<REG>_DEFAULT	Register default value	28-21
IRQ_<REG>_RMK()	Register make	28-23
IRQ_<REG>_OF()	Register value of ...	28-22
IRQ_<REG>_<FIELD>_DEFAULT	Field default value	28-24
IRQ_FMK()	Field make	28-14
IRQ_FMKS()	Field make symbolically	28-15
IRQ_<REG>_<FIELD>_OF()	Field value of ...	28-24
IRQ_<REG>_<FIELD>_<SYM>	Field symbolic value	28-24

14.3 Configuration Structure

IRQ_Config

Interrupt dispatcher configuration structure

Structure

```
typedef struct {  
    void *funcAddr;  
    Uint32 funcArg;  
    Uint32 ccMask;  
    Uint32 ieMask;  
} IRQ_Config;
```

Members

funcAddr This is the address of the interrupt service routine to be called when the interrupt happens. This function must be C-callable and must NOT be declared using the *interrupt* keyword. The prototype has the form:

```
void myIsr(  
    Uint32 funcArg,  
    Uint32 eventId  
);
```

funcArg – user defined argument

eventId – the ID of the event that caused the interrupt

funcArg This is an arbitrary user-defined argument that gets passed to the interrupt service routine. This is useful when the application code wants to pass information to an ISR without using global variables. This argument is also accessible using `IRQ_getArg()` and `IRQ_setArg()`.

ccMask Cache control mask: determines how the DSP/BIOS dispatcher handles the cache settings when calling an interrupt service routine (ISR). When an interrupt occurs and that event is being handled by the dispatcher, the dispatcher modifies the cache settings based on this argument before calling the ISR. Then when the ISR exits and control is returned back to the dispatcher, the cache settings are restored back to their original state.

The following list shows valid values for **ccMask**:

- (a) `IRQ_CC_MASK_NONE`
- (b) `IRQ_CC_MASK_DEFAULT`

- (c) IRQ_CCMASK_PCC_MAPPED
- (d) IRQ_CCMASK_PCC_ENABLE
- (e) IRQ_CCMASK_PCC_FREEZE
- (f) IRQ_CCMASK_PCC_BYPASS
- (g) IRQ_CCMASK_DCC_MAPPED
- (h) IRQ_CCMASK_DCC_ENABLE
- (i) IRQ_CCMASK_DCC_FREEZE
- (j) IRQ_CCMASK_DCC_BYPASS

Only certain combinations of the above values are valid:

(a) and (b) are mutually exclusive with all others. This means that if (a) is used, it is used by itself, likewise for (b).

IRQ_CCMASK_NONE means do not touch the cache at all.

IRQ_CCMASK_DEFAULT has the same meaning.

If neither (a) nor (b) is used, then one value from (c) through (f) bitwise OR'ed with a value from (g) through (j) may be used. In other words, choose one value for the PCC control and one value for the DCC control. It is possible to use a PCC value without a DCC value and vice-versa.

ieMask Interrupt enable mask: determines how interrupts are masked during the processing of the event. The DSP/BIOS interrupt dispatcher allows nested interrupts such that interrupts of higher priority may preempt those of lower priority (priority here is determined by hardware). The ieMask argument determines which interrupts to mask out during processing. Each bit in ieMask corresponds to bits in the interrupt enable register (IER). A "1" bit in ieMask means disable the corresponding interrupt. When processing the interrupt service routine is complete, the dispatcher restores IER back to its original state.

The user may specify a numeric value for the mask or use one of the following predefined symbols:

- IRQ_IEMASK_ALL
- IRQ_IEMASK_SELF
- IRQ_IEMASK_DEFAULT

Use `IRQ_IEMASK_ALL` to mask out all interrupts including self,

IRQ_Config

use `IRQ_IEMASK_SELF` to mask self (prevent an ISR from preempting itself), or use the default which is the same as `IRQ_IEMASK_SELF`.

Description

This is the configuration structure used to dynamically configure the DSP/BIOS interrupt dispatcher. The interrupt dispatcher may be statically configured using the configuration tool and also dynamically configured using the CSL functions `IRQ_config()`, `IRQ_configArgs()`, and `IRQ_getConfig()`. These functions allow the user to dynamically *hook* new interrupt service routines at runtime.

The DSP/BIOS dispatcher uses a lookup table to gather information for each interrupt. Each entry of this built-in table contains the same members as this configuration structure. Calling `IRQ_config()` simply copies the configuration structure members into the appropriate locations in the dispatch table.

Example 1

```
IRQ_Config myConfig = {
    myIsr,
    0x00000000,
    IRQ_CCMASK_DEFAULT,
    IRQ_IEMASK_DEFAULT
};
...
IRQ_config(eventId, &myConfig);
...
void myIsr(Uint32 funcArg, Uint32 eventId) {
    ...
}
```

Example 2

```
IRQ_Config myConfig = {
    myIsr,
    0x00000000,
    IRQ_CCMASK_PCC_ENABLE | IRQ_CCMASK_DCC_MAPPED,
    IRQ_IEMASK_ALL
};
...
IRQ_config(eventId, &myConfig);
...
void myIsr(Uint32 funcArg, Uint32 eventId) {
    ...
}
```

14.4 Functions

14.4.1 Primary IRQ Functions

IRQ_clear	<i>Clears event flag</i>
Function	void IRQ_clear(Uint32 eventId);
Arguments	eventId Event ID. See IRQ_EVT_NNNN for a complete list of events.
Return Value	none
Description	Clears the event flag from the interrupt flag register (IFR). If the event is not mapped to an interrupt, then no action is taken.
Example	<code>IRQ_clear(IRQ_EVT_TINT0);</code>

IRQ_config	<i>Dynamically configures an entry in the interrupt dispatcher table</i>
Function	void IRQ_config(Uint32 eventId, IRQ_Config *config);
Arguments	eventId Event ID. See IRQ_EVT_NNNN for a complete list of events. config Pointer to a configuration structure that contains the new configuration information. See <code>IRQ_Config</code> for a complete description of this structure.
Return Value	none
Description	This function dynamically configures an entry in the interrupt dispatcher table with the information contained in the configuration structure. To use this function, a DSP/BIOS configuration <code>.cdb</code> must be defined. Two constraints must be met before this function has any effect: 1) The event must be mapped to an interrupt 2) The interrupt this event is mapped to must be using the dispatcher

IRQ_configArgs

If either of the above two conditions are not met, this function will have no effect.

Example

```
IRQ_Config myConfig = {
    myIsr,
    0x00000000,
    IRQ_CCMASK_DEFAULT,
    IRQ_IEMASK_DEFAULT
};
...
IRQ_config(eventId, &myConfig);
```

IRQ_configArgs

Dynamically configures an entry in the interrupt dispatcher table

Function

```
void IRQ_configArgs(
    Uint32 eventId,
    void *funcAddr,
    Uint32 funcArg,
    Uint32 ccMask,
    Uint32 ieMask
);
```

Arguments

eventId Event ID. See IRQ_EVT_NNNN for a complete list of events.

funcAddr Address of the interrupt service routine. See the IRQ_Config structure definition for more details.

funcArg Argument that gets passed to the interrupt service routine. See the IRQ_Config structure definition for more details.

ccMask Cache control mask. See the IRQ_Config structure definition for more details.

ieMask Interrupt enable mask. See the IRQ_Config structure definition for more details.

Return Value

none

Description

This function dynamically configures an entry in the interrupt dispatcher table. It does the same thing as IRQ_config() except this function takes the information as arguments rather than passed in a configuration structure.

This function dynamically configures an entry in the interrupt dispatcher table with the information passed in the arguments.

To use this function, a DSP/BIOS configuration .cdb must be defined.

Two constraints must be met before this function has any effect:

- 1) The event must be mapped to an interrupt
- 2) The interrupt this event is mapped to must be using the dispatcher

If either of the above two conditions are not met, this function will have no effect.

Example

```
IRQ_configArgs (
    eventId,
    myIsr,
    0x00000000,
    IRQ_CCMASK_DEFAULT,
    IRQ_IEMASK_DEFAULT
);
```

IRQ_disable	<i>Disables specified event</i>
Function	<pre>Uint32 IRQ_disable(Uint32 eventId);</pre>
Arguments	<p>eventId Event ID. See IRQ_EVT_NNNN for a complete list of events.</p>
Return Value	<p>state Returns the old event state. Use with IRQ_restore().</p>
Description	<p>Disables the interrupt associated with the specified event by modifying the interrupt enable register (IER). If the event is not mapped to an interrupt, then no action is taken.</p>
Example	<pre>IRQ_disable(IRQ_EVT_TINT0);</pre>

IRQ_enable	<i>Enables specified event</i>
Function	<pre>void IRQ_enable(Uint32 eventId);</pre>
Arguments	<p>eventId Event ID. See IRQ_EVT_NNNN for a complete list of events.</p>
Return Value	<p>none</p>

IRQ_globalDisable

Description Enables the event by modifying the interrupt enable register (IER). If the event is not mapped to an interrupt, then no action is taken.

Example `IRQ_enable(IRQ_EVT_TINT0);`

IRQ_globalDisable *Globally disables interrupts*

Function `Uint32 IRQ_globalDisable();`

Arguments none

Return Value gie Returns the old GIE value

Description This function globally disables interrupts by clearing the GIE bit of the CSR register. The old value of GIE is returned. This is useful for temporarily disabling global interrupts, then restoring them back.

Example

```
Uint32 gie;
gie = IRQ_globalDisable();
...
IRQ_globalRestore(gie);
```

IRQ_globalEnable *Globally enables interrupts*

Function `void IRQ_globalEnable();`

Arguments none

Return Value none

Description This function globally enables interrupts by setting the GIE bit of the CSR register to 1. This function must be called if the GIE bit is not set before enabling an interrupt event. See also `IRQ_globalDisable()`;

Example

```
IRQ_globalEnable();
IRQ_enable(IRQ_EVT_TINT1);
```

IRQ_globalRestore *Restores the global interrupt enable state*

Function `void IRQ_globalRestore(
 Uint32 gie
);`

Arguments gie Value to restore the global interrupt enable to, (0=disable, 1=enable)

Return Value	none
Description	This function restores the global interrupt enable state to the value passed in by writing to the GIE bit of the CSR register. This is useful for temporarily disabling global interrupts, then restoring them back.
Example	<pre> Uint32 gie; gie = IRQ_globalDisable(); ... IRQ_globalRestore(gie); </pre>

IRQ_reset *Resets an event by disabling then clearing it*

Function	<pre> void IRQ_reset(Uint32 eventId); </pre>
Arguments	eventId Event ID. See IRQ_EVT_NNNN for a complete list of events.
Return Value	none
Description	This function serves as a shortcut method of performing IRQ_disable(eventId) followed by IRQ_clear(eventId).
Example	<pre> eventId = DMA_getEventId(hDma); IRQ_reset(eventId); </pre>

IRQ_restore *Restores an event-enable state*

Function	<pre> void IRQ_restore(Uint32 eventId, Uint32 ie); </pre>
Arguments	<p>eventId Event ID. See IRQ_EVT_NNNN for a complete list of events.</p> <p>ie State to restore the event to (0=disable, 1=enable).</p>
Return Value	none
Description	This function restores the enable state of the event to the value passed in. This is useful for temporarily disabling an event, then restoring it back.
Example	<pre> Uint32 ie; ie = IRQ_disable(eventId); ... IRQ_restore(ie); </pre>

IRQ_setVecs

IRQ_setVecs

Sets the base address of the interrupt vectors

Function void *IRQ_setVecs(
void *vecs
);

Arguments vecs Pointer to the interrupt vector table

Return Value oldVecs Returns a pointer to the old vector table

Description Use this function to set the base address of the interrupt vector table.

CAUTION: Changing the interrupt vector table base can have adverse effects on your system because you will be effectively eliminating all interrupt settings that were there previously. The DSP/BIOS kernel and RTDX will more than likely fail if care is not taken when using this function.

Example

```
IRQ_setVecs((void*) 0x80000000);
```

IRQ_test

Allows testing event to see if its flag is set in IFR register

Function Uint IRQ_test(
Uint32 eventId
);

Arguments eventId Event ID. See IRQ_EVT_NNNN for a complete list of events.

Return Value flag Returns event flag; 0 or 1

Description Use this function to test an event to see if its flag is set in the interrupt flag register (IFR). If the event is not mapped to an interrupt, then no action is taken and this function returns 0.

Example

```
while (!IRQ_test(IRQ_EVT_TINT0));
```

14.4.2 Auxiliary IRQ Functions and Constants

IRQ_EVT_NNNN *IRQ events*

Constant (For C6410, C6413 and C6418 devices)

IRQ_EVT_DSPINT
 IRQ_EVT_TINT0
 IRQ_EVT_TINT1
 IRQ_EVT_SDINTA
 IRQ_EVT_EXTINT4
 IRQ_EVT_GPINT4
 IRQ_EVT_EXTINT5
 IRQ_EVT_GPINT5
 IRQ_EVT_EXTINT6
 IRQ_EVT_GPINT6
 IRQ_EVT_EXTINT7
 IRQ_EVT_GPINT7
 IRQ_EVT_EDMAINT
 IRQ_EVT_EMUDDMA
 IRQ_EVT_EMURTDXR
 IRQ_EVT_EMURTDXTX
 IRQ_EVT_XINT0
 IRQ_EVT_RINT0
 IRQ_EVT_XINT1
 IRQ_EVT_RINT1
 IRQ_EVT_GPINT0
 IRQ_EVT_TINT2
 IRQ_EVT_I2CINT0
 IRQ_EVT_I2CINT1
 IRQ_EVT_AXINT1
 IRQ_EVT_ARINT1
 IRQ_EVT_AXINT0
 IRQ_EVT_ARINT0
 IRQ_EVT_VCPINT#
 #Defined only for C6418

(For DM642, DM641 and DM640)

IRQ_EVT_DSPINT
 IRQ_EVT_TINT0
 IRQ_EVT_TINT1
 IRQ_EVT_SDINTA
 IRQ_EVT_EXTINT4

IRQ_EVT_NNNN

IRQ_EVT_GPINT4
IRQ_EVT_EXTINT5
IRQ_EVT_GPINT5
IRQ_EVT_EXTINT6
IRQ_EVT_GPINT6
IRQ_EVT_EXTINT7
IRQ_EVT_GPINT7
IRQ_EVT_EDMAINT
IRQ_EVT_EMUDDMA
IRQ_EVT_EMURTDXR
IRQ_EVT_EMURTDXTX
IRQ_EVT_XINT0
IRQ_EVT_RINT0
IRQ_EVT_XINT1
IRQ_EVT_RINT1
IRQ_EVT_GPINT0
IRQ_EVT_TINT2
IRQ_EVT_I2CINT0
IRQ_EVT_MACINT
IRQ_EVT_VINT0
IRQ_EVT_VINT1
IRQ_EVT_VINT2# # Only for DM642
IRQ_EVT_AXINT0
IRQ_EVT_ARINT0

(For other devices)
IRQ_EVT_DSPINT
IRQ_EVT_TINT0
IRQ_EVT_TINT1
IRQ_EVT_TINT2 C64x only
IRQ_EVT_SDINT
IRQ_EVT_SDINTA C64x only
IRQ_EVT_SDINTB C64x only
IRQ_EVT_GPINT0 C64x only
IRQ_EVT_GPINT4 C64x only
IRQ_EVT_GPINT5 C64x only
IRQ_EVT_GPINT6 C64x only
IRQ_EVT_GPINT7 C64x only
IRQ_EVT_EXTINT4
IRQ_EVT_EXTINT5
IRQ_EVT_EXTINT6
IRQ_EVT_EXTINT7

IRQ_EVT_DMAINT0
 IRQ_EVT_DMAINT1
 IRQ_EVT_DMAINT2
 IRQ_EVT_DMAINT3
 IRQ_EVT_EDMAINT
 IRQ_EVT_XINT0
 IRQ_EVT_RINT0
 IRQ_EVT_XINT1
 IRQ_EVT_RINT1
 IRQ_EVT_XINT2
 IRQ_EVT_RINT2
 IRQ_EVT_PCIWAKE
 IRQ_EVT_UINTC64x only

Description These are the IRQ events. Refer to the *TMS320C6000 Peripherals Reference Guide* (SPRU190) for more details regarding these events.

IRQ_getArg *Reads the user defined interrupt service routine argument*

Function `Uint32 IRQ_getArg(
 Uint32 eventId
);`

Arguments eventId Event ID. See IRQ_EVT_NNNN for a complete list of events.

Return Value funcArg Current value of the interrupt service routine argument. For more details, see the `IRQ_Config` structure definition.

Description This function reads the user defined argument from the interrupt dispatcher table and returns it to the user.

Two constraints must be met before this function has any effect:

- 1) The event must be mapped to an interrupt
- 2) The interrupt this event is mapped to must be using the dispatcher

If either of the above two conditions are not met, this function will have no effect.

Example `Uint32 a = IRQ_getArg(eventId);`

IRQ_getConfig

IRQ_getConfig Returns the current IRQ set-up using configuration structure

Function	<pre>void IRQ_getConfig(Uint32 eventId, IRQ_Config *config);</pre>
Arguments	<p>eventId Event ID. See IRQ_EVT_NNNN for a complete list of events.</p> <p>config Pointer to a configuration structure that will be filled in with information from the dispatcher table. See <code>IRQ_Config</code> for a complete description of this structure.</p>
Return Value	none
Description	<p>This function reads information from the interrupt dispatcher table and stores it in the configuration structure.</p> <p>Two constraints must be met before this function has any effect:</p> <ol style="list-style-type: none">1) The event must be mapped to an interrupt.2) The interrupt this event is mapped to must be using the dispatcher. <p>If either of the above two conditions are not met, this function will have no effect.</p>
Example	<pre>IRQ_Config myConfig; ... IRQ_getConfig(eventId, &myConfig);</pre>

IRQ_map *Maps event to physical interrupt number*

Function	void IRQ_map(Uint32 eventId, int intNumber);
Arguments	eventId Event ID. See IRQ_EVT_NNNN for a complete list of events. intNumber Interrupt number, 4 to 15
Return Value	none
Description	This function maps an event to a physical interrupt number by configuring the interrupt selector MUX registers. For most cases, the default map is sufficient and does not need to be changed.
Example	<code>IRQ_map(IRQ_EVT_TINT0, 12);</code>

IRQ_nmiDisable *Disables the NMI interrupt event*

Function	void IRQ_nmiDisable();
Arguments	none
Return Value	none
Description	This function disables the NMI interrupt by setting the corresponding bit in IER register to 0.
Example	<code>IRQ_nmiDisable();</code>

IRQ_nmiEnable *Enables the NMI interrupt event*

Function	void IRQ_nmiEnable();
Arguments	none
Return Value	none
Description	This function enables the NMI interrupt by setting the corresponding bit in IER register to 1. Note: When using the DSP/BIOS tool, NMIE interrupt is enabled automatically.
Example	<code>IRQ_nmiEnable();</code>

IRQ_resetAll

IRQ_resetAll *Resets all interrupts events supported by the chip device*

Function	<code>void IRQ_resetAll();</code>
Arguments	none
Return Value	none
Description	Resets all the interrupt events supported by the chip device by disabling the global interrupt enable bit (GIE) and then disabling and clearing all the interrupt bits of IER and IFR, respectively.
Example	<code>IRQ_resetAll();</code>

IRQ_set *Sets specified event by writing to appropriate ISR register*

Function	<code>void IRQ_set(uint32 eventId);</code>
Arguments	<code>eventId</code> Event ID. See <code>IRQ_EVT_NNNN</code> for a complete list of events.
Return Value	none
Description	Sets the specified event by writing to the appropriate bit in the interrupt set register (ISR). This basically allows software triggering of events. If the event is not mapped to an interrupt, then no action is taken.
Example	<code>IRQ_set (IRQ_EVT_TINT0);</code>

IRQ_setArg *Sets the user-defined interrupt service routine argument*

Function	void IRQ_setArg(Uint32 eventId, Uint32 funcArg);
Arguments	<p>eventId Event ID. See IRQ_EVT_NNNN for a complete list of events.</p> <p>funcArg New value for the interrupt service routine argument. See the IRQ_Config structure definition for more details.</p>
Return Value	none
Description	<p>This function sets the user-defined argument in the interrupt dispatcher table.</p> <p>Two constraints must be met before this function has any effect:</p> <ol style="list-style-type: none"> 1) The event must be mapped to an interrupt 2) The interrupt this event is mapped to must be using the dispatcher <p>If either of the above two conditions are not met, this function will have no effect.</p>
Example	<pre>IRQ_setArg(eventId, 0x12345678);</pre>

IRQ_SUPPORT *Compile time constant*

Constant	IRQ_SUPPORT
Description	<p>Compile time constant that has a value of 1 if the device supports the IRQ module and 0 otherwise. You are not required to use this constant. Currently, all devices support this module.</p>
Example	<pre>#if (IRQ_SUPPORT) /* user IRQ configuration */ #endif</pre>



McASP Module

This chapter describes the McASP module, lists the API functions and macros within the module, discusses using a McASP device, and provides a McASP API reference section.

Topic	Page
15.1 Overview	15-2
15.2 Macros	15-5
15.3 Configuration Structure	15-7
15.4 Functions	15-10

15.1 Overview

The McASP module contains a set of API functions for configuring the McASP registers.

Table 15–1 lists the configuration structure for use with the McASP functions. Table 15–2 lists the functions and constants available in the CSL McASP module.

Table 15–1. McASP Configuration Structures

Syntax	Type	Description	See page ...
MCASP_Config	S	Used to configure a McASP device	15-7
MCASP_ConfigGbl	S	Used to configure McASP global receive registers	15-7
MCASP_ConfigRcv	S	Used to configure McASP receive registers	15-8
MCASP_ConfigSrctl	S	Used to configure McASP serial control	15-8
MCASP_ConfigXmt	S	Used to configure McASP transmit registers	15-9

Table 15–2. McASP APIs

(a) Primary Functions

Syntax	Type	Description	See page ...
MCASP_close	F	Closes a McASP device previously opened via <code>MCASP_open()</code>	15-10
MCASP_config	F	Configures the McASP device using the configuration structure	15-10
MCASP_open	F	Opens a McASP device for use	15-11
MCASP_read32	F	Reads data when the receiver is configured to receive from the data bus	15-12
MCASP_reset	F	Resets McASP registers to their default values	15-12
MCASP_write32	F	Writes data when the transmitter is configured to transmit by the data bus	15-13

(b) Parameters and Constants

Syntax	Type	Description	See page ...
MCASP_DEVICE_CNT	C	McASP device count	15-14
MCASP_OPEN_RESET	C	McASP open reset flag	15-14

Note: S = Structure, T = Typedef, F = Function; C = Constant

Table 15–2. McASP APIs (Continued)

Syntax	Type	Description	See page ...
MCASP_SetupClk	T	Parameters for McASP transmit and receive clock registers	15-14
MCASP_SetupFormat	T	Parameters for data stream format: XFMT–RFMT	15-15
MCASP_SetupFsync	T	Parameters for frame synchronization control: AFSXCTL–AFSRCTL	15-16
MCASP_SetupHclk	T	Parameters for McASP transmit and receive high registers	15-16
MCASP_SUPPORT	C	Compile time constant whose value is 1 if the device supports the McASP module	15-17

(c) Auxiliary Functions

Syntax	Type	Description	See page ...
MCASP_clearPins	F	Clears pins which are enabled as GPIO and output	15-17
MCASP_configDit	F	Configures XMASK, XTDM, and AFSXCTL registers for DIT transmission	15-18
MCASP_configGbl	F	Configures McASP device global registers	15-18
MCASP_configRcv	F	Configures McASP device receive registers	15-19
MCASP_configSrctl	F	Configures McASP device serial control registers	15-19
MCASP_configXmt	F	Configures McASP device transmit registers	15-20
MCASP_enableClk	F	Wakes up transmit and/or receive clock, depending on direction	15-20
MCASP_enableFsync	F	Enables frame sync if receiver has internal frame sync	15-21
MCASP_enableHclk	F	Wakes up transmit and or receive high clock, depending on direction	15-22
MCASP_enableSers	F	Enables transmit or receive serializers, depending on direction	15-23
MCASP_enableSm	F	Wakes up transmit and or receive state machine, depending on direction	15-24
MCASP_getConfig	F	Reads the current McASP configuration values	15-25
MCASP_getGblctl	F	Reads the GBLCTL register, depending on direction	15-25

Note: S = Structure, T = Typedef, F = Function; C = Constant

Table 15–2. McASP APIs (Continued)

Syntax	Type	Description	See page ...
MCASP_read32Cfg	F	Reads the data from rbufNum	15-26
MCASP_resetRcv	F	Resets the receiver fields in the Global Control register	15-26
MCASP_resetXmt	F	Resets the transmitter fields in the Global Control register	15-27
MCASP_setPins	F	Sets pins which are enabled as GPIO and output	15-27
MCASP_setupClk	F	Sets up McASP transmit and receive clock registers	15-28
MCASP_setupFormat	F	Sets up McASP transmit and receive format registers	15-28
MCASP_setupFsync	F	Sets up McASP transmit and receive frame sync registers	15-29
MCASP_setupHclk	F	Sets up McASP transmit and receive high clock registers	15-29
MCASP_write32Cfg	F	Writes the val into rbufNum	15-30

(c) Interrupt Control Functions

Syntax	Type	Description	See page ...
MCASP_getRcvEventId	F	Retrieves the receive event ID for the given device	15-30
MCASP_getXmtEventId	F	Retrieves the transmit event ID for the given device	15-31

Note: S = Structure, T = Typedef, F = Function; C = Constant

15.1.1 Using a McASP Device

To use a McASP device, the user must first open it and obtain a device handle using `MCASP_open()`. Once opened, the device handle should then be passed to other APIs along with other arguments. The McASP device can be configured by passing a `MCASP_Config` structure to `MCASP_config()`. To assist in creating register values, the `MCASP_RMK` (make) macros construct register values based on field values. Once the McASP device is no longer needed, it should be closed by passing the corresponding handle to `MCASP_close()`.

15.2 Macros

There are two types of McASP macros: those that access registers and fields, and those that construct register and field values.

Table 15–3 lists the McASP macros that access registers and fields, and Table 15–4 lists the McASP macros that construct register and field values. The macros themselves are found in Chapter 28, *Using the HAL Macros*.

The McASP module includes handle-based macros.

Table 15–3. McASP Macros that Access Registers and Fields

Macro	Description/Purpose	See page ...
MCASP_ADDR(<REG>)	Register address	28-12
MCASP_RGET(<REG>)	Returns the value in the peripheral register	28-18
MCASP_RSET(<REG>,x)	Register set	28-20
MCASP_FGET(<REG>,<FIELD>)	Returns the value of the specified field in the peripheral register	28-13
MCASP_FSET(<REG>,<FIELD>,fieldval)	Writes <i>fieldval</i> to the specified field in the peripheral register	28-15
MCASP_FSETS(<REG>,<FIELD>,<SYM>)	Writes the symbol value to the specified field in the peripheral	28-17
MCASP_RGETA(addr,<REG>)	Gets register for a given address	28-19
MCASP_RSETA(addr,<REG>,x)	Sets register for a given address	28-20
MCASP_FGETA(addr,<REG>,<FIELD>)	Gets field for a given address	28-13
MCASP_FSETA(addr,<REG>,<FIELD>,fieldval)	Sets field for a given address	28-16
MCASP_FSETSA(addr,<REG>,<FIELD>,<SYM>)	Sets field symbolically for a given address	28-17
MCASP_ADDRH(h,<REG>)	Returns the address of a memory-mapped register for a given handle	28-12
MCASP_RGETH(h,<REG>)	Returns the value of a register for a given handle	28-19
MCASP_RSETH(h,<REG>,x)	Sets the register value to x for a given handle	28-21
MCASP_FGETH(h,<REG>,<FIELD>)	Returns the value of the field for a given handle	28-14
MCASP_FSETH(h,<REG>,<FIELD>,fieldval)	Sets the field value to x for a given handle	28-16

Table 15–4. McASP Macros that Construct Register and Field Values

Macro	Description/Purpose	See page ...
MCASP_<REG>_DEFAULT	Register default value	28-21
MCASP_<REG>_RMK()	Register make	28-23
MCASP_<REG>_OF()	Register value of ...	28-22
MCASP_<REG>_<FIELD>_DEFAULT	Field default value	28-24
MCASP_FMKS()	Field make	28-14
MCASP_FMKS()	Field make symbolically	28-15
MCASP_<REG>_<FIELD>_OF()	Field value of ...	28-24
MCASP_<REG>_<FIELD>_<SYM>	Field symbolic value	28-24

15.3 Configuration Structure

MCASP_Config *Structure used to configure a McASP device*

Structure	MCASP_Config		
Members	MCASP_ConfigGbl	*global	Global registers
	MCASP_ConfigRcv	*receive	Receive registers
	MCASP_ConfigXmt	*transmit	Transmit registers
	MCASP_ConfigSrctl	*srctl	Serial control registers
Description	This is the McASP configuration structure used to set up a McASP device. The user can create and initialize this structure and then pass its address to the <code>MCASP_config()</code> function.		

MCASP_ConfigGbl *Structure used to configure McASP global registers*

Structure	MCASP_ConfigGbl		
Members	Uin32	pfunc	Specifies if the McASP pins are McASP or GPIO pins. Default is 0 = McASP.
	Uin32	pdir	Specifies the direction of pins as input/output. Default is 0 = input.
	Uin32	ditctl	Specifies the DIT configuration.
	Uin32	dlbctl	Specifies the loopback mode and kind loopback (odd serializers (receiver) to even serializers(receivers) or vice versa).
	Uin32	amute	Specifies the AMUTE register configuration.
Description	This is the McASP configuration structure used to configure McASP device global registers. The user can create and initialize this structure and then pass its address to the <code>MCASP_configGbl()</code> function.		

MCASP_ConfigRcv

MCASP_ConfigRcv *Structure used to configure McASP receive registers*

Structure	MCASP_ConfigRcv																								
Members	<table><tr><td>UInt32</td><td>rmask</td><td>Specifies the mask value for receive data.</td></tr><tr><td>UInt32</td><td>rfmt</td><td>Specifies the format for receive data.</td></tr><tr><td>UInt32</td><td>afsrctl</td><td>Specifies the receive frame sync configuration.</td></tr><tr><td>UInt32</td><td>aclkrctl</td><td>Specifies the receive serial clock configuration.</td></tr><tr><td>UInt32</td><td>ahclkrctl</td><td>Specifies the receive high clock configuration.</td></tr><tr><td>UInt32</td><td>rtdm</td><td>Specifies the active receive tdm slots.</td></tr><tr><td>UInt32</td><td>rintct</td><td>Specifies the active events for receive.</td></tr><tr><td>UInt32</td><td>rclkchk</td><td>Specifies the receive serial clock control configuration.</td></tr></table>	UInt32	rmask	Specifies the mask value for receive data.	UInt32	rfmt	Specifies the format for receive data.	UInt32	afsrctl	Specifies the receive frame sync configuration.	UInt32	aclkrctl	Specifies the receive serial clock configuration.	UInt32	ahclkrctl	Specifies the receive high clock configuration.	UInt32	rtdm	Specifies the active receive tdm slots.	UInt32	rintct	Specifies the active events for receive.	UInt32	rclkchk	Specifies the receive serial clock control configuration.
UInt32	rmask	Specifies the mask value for receive data.																							
UInt32	rfmt	Specifies the format for receive data.																							
UInt32	afsrctl	Specifies the receive frame sync configuration.																							
UInt32	aclkrctl	Specifies the receive serial clock configuration.																							
UInt32	ahclkrctl	Specifies the receive high clock configuration.																							
UInt32	rtdm	Specifies the active receive tdm slots.																							
UInt32	rintct	Specifies the active events for receive.																							
UInt32	rclkchk	Specifies the receive serial clock control configuration.																							
Description	This is the McASP configuration structure used to configure McASP device receive registers. The user can create and initialize this structure and then pass its address to the <code>MCASP_configRcv()</code> function.																								

MCASP_ConfigSrctl *Structure used to configure McASP serial control registers*

Structure	MCASP_ConfigSrctl																																																
Members	<table><tr><td>UInt32</td><td>srctl0</td><td>Configures the serial control for pin 0</td></tr><tr><td>UInt32</td><td>srctl1</td><td>Configures the serial control for pin 1</td></tr><tr><td>UInt32</td><td>srctl2</td><td>Configures the serial control for pin 2</td></tr><tr><td>UInt32</td><td>srctl3</td><td>Configures the serial control for pin 3</td></tr><tr><td>UInt32</td><td>srctl4@</td><td>Configures the serial control for pin 4</td></tr><tr><td>UInt32</td><td>srctl5@</td><td>Configures the serial control for pin 5</td></tr><tr><td>UInt32</td><td>srctl6#</td><td>Configures the serial control for pin 6</td></tr><tr><td>UInt32</td><td>srctl7#</td><td>Configures the serial control for pin 7</td></tr><tr><td>UInt32</td><td>srctl8!</td><td>Configures the serial control for pin 8</td></tr><tr><td>UInt32</td><td>srctl9!</td><td>Configures the serial control for pin 9</td></tr><tr><td>UInt32</td><td>srctl10!</td><td>Configures the serial control for pin 10</td></tr><tr><td>UInt32</td><td>srctl11!</td><td>Configures the serial control for pin 11</td></tr><tr><td>UInt32</td><td>srctl12!</td><td>Configures the serial control for pin 12</td></tr><tr><td>UInt32</td><td>srctl13!</td><td>Configures the serial control for pin 13</td></tr><tr><td>UInt32</td><td>srctl14!</td><td>Configures the serial control for pin 14</td></tr><tr><td>UInt32</td><td>srctl15!</td><td>Configures the serial control for pin 15</td></tr></table> <p>@ Only for DM642, C6410, C6413, C6418, C6713 and DA610 # Only for DM642, C6713 and DA610 ! Only for DA610</p>	UInt32	srctl0	Configures the serial control for pin 0	UInt32	srctl1	Configures the serial control for pin 1	UInt32	srctl2	Configures the serial control for pin 2	UInt32	srctl3	Configures the serial control for pin 3	UInt32	srctl4@	Configures the serial control for pin 4	UInt32	srctl5@	Configures the serial control for pin 5	UInt32	srctl6#	Configures the serial control for pin 6	UInt32	srctl7#	Configures the serial control for pin 7	UInt32	srctl8!	Configures the serial control for pin 8	UInt32	srctl9!	Configures the serial control for pin 9	UInt32	srctl10!	Configures the serial control for pin 10	UInt32	srctl11!	Configures the serial control for pin 11	UInt32	srctl12!	Configures the serial control for pin 12	UInt32	srctl13!	Configures the serial control for pin 13	UInt32	srctl14!	Configures the serial control for pin 14	UInt32	srctl15!	Configures the serial control for pin 15
UInt32	srctl0	Configures the serial control for pin 0																																															
UInt32	srctl1	Configures the serial control for pin 1																																															
UInt32	srctl2	Configures the serial control for pin 2																																															
UInt32	srctl3	Configures the serial control for pin 3																																															
UInt32	srctl4@	Configures the serial control for pin 4																																															
UInt32	srctl5@	Configures the serial control for pin 5																																															
UInt32	srctl6#	Configures the serial control for pin 6																																															
UInt32	srctl7#	Configures the serial control for pin 7																																															
UInt32	srctl8!	Configures the serial control for pin 8																																															
UInt32	srctl9!	Configures the serial control for pin 9																																															
UInt32	srctl10!	Configures the serial control for pin 10																																															
UInt32	srctl11!	Configures the serial control for pin 11																																															
UInt32	srctl12!	Configures the serial control for pin 12																																															
UInt32	srctl13!	Configures the serial control for pin 13																																															
UInt32	srctl14!	Configures the serial control for pin 14																																															
UInt32	srctl15!	Configures the serial control for pin 15																																															

Description This is the McASP configuration structure used to configure McASP device serial control registers. The user can create and initialize this structure and then pass its address to the `MCASP_configSrctl()` function.

MCASP_ConfigXmt *Structure used to configure McASP transmit registers*

Structure MCASP_ConfigXmt

Members

UInt32	xmask	Specifies the mask value for transmit data.
UInt32	xfmt	Specifies the format for transmit data.
UInt32	afsxctl	Specifies the transmit frame sync configuration.
UInt32	aclkxctl	Specifies the transmit serial clock configuration.
UInt32	ahclkxctl	Specifies the transmit high clock configuration.
UInt32	xtdm	Specifies the active transmit tdm slots.
UInt32	xintct	Specifies the active events for transmit.
UInt32	xclkchk	Specifies the transmit serial clock control configuration.

Description This is the McASP configuration structure used to configure McASP device transmit registers. The user can create and initialize this structure and then pass its address to the `MCASP_configXmt()` function.

MCASP_close

15.4 Functions

15.4.1 Primary Functions

MCASP_close *Closes a McASP device previously opened via MCASP_open()*

Function	<pre>void MCASP_close(MCASP_Handle hMcasp);</pre>
Arguments	<pre>hMcasp Handle to McASP device, see MCASP_open()</pre>
Return Value	none
Description	This function closes a McASP device previously opened via <code>MCASP_open()</code> . The following tasks are performed: the registers for the McASP device are set to their defaults, and the McASP handle is closed.
Example	<pre>MCASP_close(hMcasp);</pre>

MCASP_config *Configures the McASP device using the configuration structure*

Function	<pre>void MCASP_config(MCASP_Handle hMcasp, MCASP_Config *myConfig);</pre>
Arguments	<pre>hMcasp Handle to McASP device. See MCASP_open() myConfig Pointer to an initialized configuration structure</pre>
Return Value	none
Description	This function configures the McASP device using the configuration structure. The values of the structure members are written to the McASP registers. This structure is passed on to the <code>MCASP_config()</code> functions. See also <code>MCASP_getConfig()</code> , <code>MCASP_configGbl()</code> , <code>MCASP_configRcv()</code> , <code>MCASP_configXmt()</code> , and <code>MCASP_configSrctl()</code> .
Example	<pre>MCASP_Config MyConfig = { ... MCASP_config(hMcasp, &MyConfig);</pre>

MCASP_open *Opens a McASP device*

Function	<pre> MCASP_Handle MCASP_open(int devNum, Uint32 flags); </pre>
Arguments	<p>devNum McASP device to be opened:</p> <ul style="list-style-type: none"> <input type="checkbox"/> MCASP_DEV0 <input type="checkbox"/> MCASP_DEV1 <p>flags Open flags</p> <ul style="list-style-type: none"> <input type="checkbox"/> MCASP_OPEN_RESET: resets the McASP
Return Value	Device Handle Returns a device handle
Description	<p>Before a McASP device can be used, it must first be opened by this function. Once opened, it cannot be opened again until it is closed. See <code>MCASP_close()</code>. The return value is a unique device handle that is used in subsequent McASP API calls. If the open fails, 'INV' is returned.</p> <p>If the <code>MCASP_OPEN_RESET</code> is specified, the McASP device registers are set to their power-on defaults.</p>
Example	<pre> MCASP_Handle hMcas; ... hMcas = MCASP_open(MCASP_DEV0,MCASP_OPEN_RESET); or hMcas = MCASP_open(MCASP_DEV1, 0); </pre>

MCASP_read32

MCASP_read32 *Reads data when the receiver is configured to receive from data bus*

Function	Uint32 MCASP_read32(MCASP_Handle hMcasp);
Arguments	hMcasp Handle to McASP port. See MCASP_open()
Return Value	Uint32 Returns the data received by McASP
Description	This function reads data when the receiver is configured to receive from the peripheral data bus.
Example	<pre>MCASP_Handle hMcasp; ... val = MCASP_read32(hMcasp); // Read data from the Address space for the McASP MCASP_Handle hMcasp; Uint32 i; extern far dstBuf[8]; ... for (i = 0; i < 8; i++) { val = MCASP_read32(hMcasp); //Reads data }</pre>

MCASP_reset *Resets McASP registers to their default values*

Function	void MCASP_reset(MCASP_Handle hMcasp);
Arguments	hMcasp Handle to McASP device. See MCASP_open()
Return Value	none
Description	This function resets the McASP registers to their default values.
Example	<pre>MCASP_Handle hMcasp; ... MCASP_reset(hMcasp);</pre>

MCASP_write32 *Writes data when the transmitter is configured to transmit by data bus*

Function	<pre>void MCASP_write32(MCASP_Handle hMcasp, Uint32 val);</pre>
Arguments	<p>hMcasp Handle to McASP port. See <code>MCASP_open()</code></p> <p>val Value to be transmitted</p>
Return Value	none
Description	This function writes data when the transmitter is configured to transmit to the peripheral data bus.
Example	<pre>MCASP_Handle hMcasp; Uint32 val; val = 30; ... MCASP_write32(hMcasp); // Writes data into the Address space for the McASP MCASP_Handle hMcasp; Uint32 i; ... for (i = 0; i < 8; i++) { MCASP_write32(hMcasp,i); // Writes data through the peripheral data bus for McASP }</pre>

15.4.2 Parameters and Constants

MCASP_DEVICE_CNT *McASP device count*

Constant	MCASP_DEVICE_CNT
Description	Compile-time constant that holds the number of McASP devices present on the current device.

MCASP_OPEN_RESET *McASP open reset flag*

Constant	MCASP_OPEN_RESET
Description	Compile-time constant that holds the number of McASP devices present on the current device.
Example	See <code>MCASP_open()</code> .

MCASP_SetupClk *Parameters for McASP transmit and receive clock registers*

Structure	MCASP_SetupClk
Members	Uint32 syncmode Transmit and receive clock synchronous flag Uint32 xclsrc Transmit clock source Uint32 xclkpol Transmit clock polarity Uint32 xclkdiv Transmit clock div Uint32 rclsrc Receive clock source Uint32 rclkpol Receive clock polarity Uint32 rclkdiv Receive clock div
Description	This is the clock configuration structure used to set up transmit and receive clocks for the McASP device. The user can create and initialize this structure and then pass its address to the <code>MCASP_setupClk()</code> function.

MCASP_SetupFormat *Parameters for data streams format: XFMT–RFMT*

Structure	MCASP_SetupFormat		
Members	UInt32	xbusel	Selects peripheral config/data bus for transmit
	MCASP_Dsprep	xdsprep	DSP representation:Q31/Integer
	UInt32	xslotsize	8–32 bits XSSZ field – XFMT register
	UInt32	xwordsize	Rotation right
	UInt32	xalign	Left/right aligned
	UInt32	xpad	Pad value for extra bits
	UInt32	xpbit	Which bit to pad the extra bits
	UInt32	xorder	MSB/LSB XRVRS field – XFMT register
	UInt32	xdelay	Bit delay – XFMT register
	UInt32	rbusel	Selects peripheral config/data bus for receive
	MCASP_Dsprep	rdsprep	DSP representation:Q31/Integer
	UInt32	rslotsize	8–32 bits RSSZ field – RFMT register
	UInt32	rwordsize	Rotation right
	UInt32	ralign	Left/right aligned
	UInt32	rpadd	Pad value for extra bits
	UInt32	rpbit	Which bit to pad the extra bits
	UInt32	rorder	MSB/LSB XRVRS field – RFMT register
	UInt32	rdelay	FSXDLY Bit delay – RFMT register

Description This is the format configuration structure used to set up transmit and receive formats for the McASP device. The user can create and initialize this structure and then pass its address to the `MCASP_setupFormat()` function.

MCASP_SetupFsync

MCASP_SetupFsync *Parameters for frame sync control: AFSXCTL – AFSRCTL*

Structure	MCASP_SetupFsync																														
Members	<table><tr><td>Uint32</td><td>xmode</td><td>TDM-BURST: FSXMOD – AFSXCTL register</td></tr><tr><td>Uint32</td><td>xslotsize</td><td>Number of slots for TDM: FSXMOD – AFSXCTL register</td></tr><tr><td>Uint32</td><td>xfssrc</td><td>Internal/external AFSXE – AFSXCTL register</td></tr><tr><td>Uint32</td><td>xfspol</td><td>Transmit clock polarity FSXPOL – AFSXCTL register</td></tr><tr><td>Uint32</td><td>fxwid</td><td>Transmit frame duration FXWID – AFSXCTL register</td></tr><tr><td>Uint32</td><td>rmode</td><td>TDM-BURST: FSRMOD – AFSRCTL register</td></tr><tr><td>Uint32</td><td>rslotsize</td><td>Number of slots for TDM: FSRMOD – AFSRCTL register</td></tr><tr><td>Uint32</td><td>rfssrc</td><td>Receive internal/external AFSRE – AFSRCTL register</td></tr><tr><td>Uint32</td><td>rfspol</td><td>Receive clock polarity FSRPOL – AFSRCTL register</td></tr><tr><td>Uint32</td><td>rxwid</td><td>Receive frame duration FRWID – AFSRCTL register</td></tr></table>	Uint32	xmode	TDM-BURST: FSXMOD – AFSXCTL register	Uint32	xslotsize	Number of slots for TDM: FSXMOD – AFSXCTL register	Uint32	xfssrc	Internal/external AFSXE – AFSXCTL register	Uint32	xfspol	Transmit clock polarity FSXPOL – AFSXCTL register	Uint32	fxwid	Transmit frame duration FXWID – AFSXCTL register	Uint32	rmode	TDM-BURST: FSRMOD – AFSRCTL register	Uint32	rslotsize	Number of slots for TDM: FSRMOD – AFSRCTL register	Uint32	rfssrc	Receive internal/external AFSRE – AFSRCTL register	Uint32	rfspol	Receive clock polarity FSRPOL – AFSRCTL register	Uint32	rxwid	Receive frame duration FRWID – AFSRCTL register
Uint32	xmode	TDM-BURST: FSXMOD – AFSXCTL register																													
Uint32	xslotsize	Number of slots for TDM: FSXMOD – AFSXCTL register																													
Uint32	xfssrc	Internal/external AFSXE – AFSXCTL register																													
Uint32	xfspol	Transmit clock polarity FSXPOL – AFSXCTL register																													
Uint32	fxwid	Transmit frame duration FXWID – AFSXCTL register																													
Uint32	rmode	TDM-BURST: FSRMOD – AFSRCTL register																													
Uint32	rslotsize	Number of slots for TDM: FSRMOD – AFSRCTL register																													
Uint32	rfssrc	Receive internal/external AFSRE – AFSRCTL register																													
Uint32	rfspol	Receive clock polarity FSRPOL – AFSRCTL register																													
Uint32	rxwid	Receive frame duration FRWID – AFSRCTL register																													
Description	This is the frame sync configuration structure used to set up transmit and receive frame sync for the McASP device. The user can create and initialize this structure and then pass its address to the <code>MCASP_setupFsync()</code> function.																														

MCASP_SetupHclk *Parameters for McASP transmit and receive high clock registers*

Structure	MCASP_SetupHclk																		
Members	<table><tr><td>Uint32</td><td>xhclksrc</td><td>Transmit high clock source</td></tr><tr><td>Uint32</td><td>xhclkpol</td><td>Transmit high clock polarity</td></tr><tr><td>Uint32</td><td>xhclkdiv</td><td>Transmit high clock div</td></tr><tr><td>Uint32</td><td>rhclksrc</td><td>Receive high clock source</td></tr><tr><td>Uint32</td><td>rhclkpol</td><td>Receive high clock polarity</td></tr><tr><td>Uint32</td><td>rhclkdiv</td><td>Receive high clock div</td></tr></table>	Uint32	xhclksrc	Transmit high clock source	Uint32	xhclkpol	Transmit high clock polarity	Uint32	xhclkdiv	Transmit high clock div	Uint32	rhclksrc	Receive high clock source	Uint32	rhclkpol	Receive high clock polarity	Uint32	rhclkdiv	Receive high clock div
Uint32	xhclksrc	Transmit high clock source																	
Uint32	xhclkpol	Transmit high clock polarity																	
Uint32	xhclkdiv	Transmit high clock div																	
Uint32	rhclksrc	Receive high clock source																	
Uint32	rhclkpol	Receive high clock polarity																	
Uint32	rhclkdiv	Receive high clock div																	
Description	This is the high clock configuration structure used to set up transmit and receive high clocks for the McASP device. The user can create and initialize this structure and then pass its address to the <code>MCASP_setupHclk()</code> function.																		

MCASP_SUPPORT *Compile time constant*

Constant	MCASP_SUPPORT
Description	Compile-time constant that has a value of 1 if the device supports the McASP module and 0 otherwise. You are not required to use this constant. Currently, the C6713 device supports this module.
Example	<pre>#if (MCASP_SUPPORT) /* user MCASP configuration / #endif</pre>

15.4.3 Auxiliary Functions

MCASP_clearPins *Clear pins which are enabled as GPIO and output*

Function	<pre>void MCASP_clearPins(MCASP_Handle hMcasP, Uint32 pins)</pre>				
Arguments	<table><tr><td>hMcasP</td><td>Handle to McASP device. See <code>MCASP_open()</code></td></tr><tr><td>pins</td><td>Mask value for the pins</td></tr></table>	hMcasP	Handle to McASP device. See <code>MCASP_open()</code>	pins	Mask value for the pins
hMcasP	Handle to McASP device. See <code>MCASP_open()</code>				
pins	Mask value for the pins				
Return Value	none				
Description	This function sets the the PDCLR register with the mask value pins specified in 'pins'. This function is used for those McASP pins which are configured as GPIO and are in output direction. Writing a 1 clears the corresponding bit in PDOUT as 1. Writing a 0 leaves it unchanged. The PDCLR register is an alias of the PDOUT register.				
Example	<pre>MCASP_Handle hMcasP; ... MCASP_clearPins(hMcasP, 0x101); // Clears bits 0,4 in PDOUT</pre>				

MCASP_configDit

MCASP_configDit *Configures XMASK/XTDM/AFSXCTL registers for DIT transmission*

Function	<pre>void MCASP_configDit(MCASP_Handle hMcas, Dsprep dpsrep, Uint32 datalen) </pre>
Arguments	<p>hMcas Handle to McASP device. See <code>MCASP_open()</code></p> <p>dsprep Q31/Integer</p> <p>datalen 16–24 bits</p>
Return Value	none
Description	This function sets up XMAS, XTDM and AFSXCTL registers depending on the representation <code>MCASP_Dsprep</code> and <code>datalen</code> .
Example	<pre>MCASP_Handle hMcas; ... MCASP_configDit(hMcas, 1, 24); //Set up DIT transmission for Q31 24-bit data type MCASP_configDit(hMcas, 0, 20); //Set up DIT transmission for Int 20-bit data type </pre>

MCASP_configGbl *Configures McASP device global registers*

Function	<pre>void MCASP_configGbl(MCASP_Handle hMcas, MCASP_ConfigGbl *myConfigGbl) </pre>
Arguments	<p>hMcas Handle to McASP device. See <code>MCASP_open()</code></p> <p>myConfigGbl Pointer to the configuration structure</p>
Return Value	none
Description	This function configures McASP device global registers using the configuration structure <code>MCASP_ConfigGbl</code> . The values of the structure-members are written to McASP registers. See also <code>MCASP_getConfig()</code> , <code>MCASP_config()</code> , <code>MCASP_configRcv()</code> , <code>MCASP_configXmt()</code> , and <code>MCASP_configSrctl()</code> .

Example

```
MCASP_ConfigGbl MyConfigGbl;
...
MCASP_configGbl(hMcaspl, &MyConfigGbl);
```

MCASP_configRcv *Configures McASP device receive registers*

Function void MCASP_configRcv(
 MCASP_Handle hMcaspl,
 MCASP_ConfigRcv *myConfigRcv
)

Arguments hMcaspl Handle to McASP device. See MCASP_open()
 myConfigRcv Pointer to the configuration structure

Return Value none

Description This function configures McASP device receive registers using the configuration structure MCASP_ConfigRcv. The values of the structure-members are written to McASP registers. See also MCASP_getConfig(), MCASP_config(), MCASP_configGbl(), MCASP_configXmt(), and MCASP_configSrctl().

Example

```
MCASP_ConfigRcv MyConfigRcv;
...
MCASP_configRcv(hMcaspl, &MyConfigRcv);
```

MCASP_configSrctl *Configures McASP device serial control registers*

Function void MCASP_configSrctl(
 MCASP_Handle hMcaspl,
 MCASP_ConfigSrctl *myConfigSrctl
)

Arguments hMcaspl Handle to McASP device. See MCASP_open()
 myConfigSrctl Pointer to the configuration structure

Return Value none

Description This function configures McASP device serial control registers using the configuration structure MCASP_ConfigSrctl. The values of the structure-members are written to McASP registers. See also MCASP_getConfig(), MCASP_config(), MCASP_configGbl(), MCASP_configXmt(), and MCASP_configRcv().

MCASP_configXmt

Example

```
MCASP_ConfigSrctl MyConfigSrctl;
...
MCASP_configSrctl(hMcaspl, &MyConfigSrctl);
```

MCASP_configXmt *Configures McASP device transmit registers*

Function

```
void MCASP_configXmt(
    MCASP_Handle    hMcaspl,
    MCASP_ConfigXmt *myConfigXmt
)
```

Arguments

hMcaspl Handle to McASP device. See MCASP_open()

myConfigXmt Pointer to the configuration structure

Return Value none

Description This function configures McASP device transmit registers using the configuration structure MCASP_ConfigXmt. The values of the structure-members are written to McASP registers. See also MCASP_getConfig(), MCASP_config(), MCASP_configGbl(), MCASP_configSrctl(), and MCASP_configRcv().

Example

```
MCASP_ConfigXmt MyConfigXmt;
...
MCASP_configXmt(hMcaspl, &MyConfigXmt);
```

MCASP_enableClk *Wakes up transmit and/or receive clock, depending on direction*

Function

```
void MCASP_enableClk(
    MCASP_Handle    hMcaspl,
    Uint32          direction
)
```

Arguments

hMcaspl Handle to McASP device. See MCASP_open()

direction direction of the clock

- MCASP_RCV
- MCASP_XMT
- MCASP_RCVXMT
- MCASP_XMTRCV

Return Value none

Description This function wakes up the transmit or receive (or both) clock out of reset by writing into RCLKRST and XCLKRST of GBLCTL. This function should only be used when the corresponding clock is internal.

Example

```
MCASP_Handle hMcas;
...
MCASP_enableClk(hMcas, MCASP_RCV); //Wakes up receive clock
MCASP_enableClk(hMcas, MCASP_XMT); //Wakes up transmit clock
MCASP_enableClk(hMcas, MCASP_XMTRCV); //Wakes up transmit and
                                        receive clock
MCASP_enableClk(hMcas, MCASP_RCVXMT); //Wakes up receive and
                                        transmit clock
```

MCASP_enableFsync *Enables frame sync if receiver has internal frame sync*

Function

```
void MCASP_enableFsync(
    MCASP_Handle hMcas,
    Uint32 direction
)
```

Arguments

hMcas Handle to McASP device. See MCASP_open ()

direction direction of frame sync

- MCASP_RCV
- MCASP_XMT
- MCASP_RCVXMT
- MCASP_XMTRCV

Return Value none

Description This function wakes up the transmit or receive (or both) frame sync out of reset by writing into RFSRST and XFSRST of GBLCTL. This function should only be used when the corresponding frame sync is internal.

MCASP_enableHclk

Example

```
MCASP_Handle hMcas;
...
MCASP_enableFsync(hMcas, MCASP_RCV); //Wakes up receive frame
                                     sync
MCASP_enableFsync(hMcas, MCASP_XMT); //Wakes up transmit
                                     frame sync
MCASP_enableFsync(hMcas, MCASP_XMTRCV); //Wakes up transmit
                                         and receive frame sync
MCASP_enableFsync(hMcas, MCASP_RCVXMT); //Wakes up receive
                                         and transmit frame sync
```

MCASP_enableHclk *Wakes up transmit and/or receive high clock, depending on direction*

Function

```
void MCASP_enableHclk(
    MCASP_Handle  hMcas,
    Uint32        direction
)
```

Arguments

hMcas Handle to McASP device. See `MCASP_open()`
direction direction of the high clock

- MCASP_RCV
- MCASP_XMT
- MCASP_RCVXMT
- MCASP_XMTRCV

Return Value

none

Description

This function wakes up the transmit or receive (or both) high clock out of reset by writing into RHCLKRST and XHCLKRST of GBLCTL. This function should only be used when the corresponding high clock is internal.

Example

```
MCASP_Handle hMcas;
...
MCASP_enableHclk(hMcas, MCASP_RCV); //Wakes up receive high
                                     clock
MCASP_enableHclk(hMcas, MCASP_XMT); //Wakes up transmit high
                                     clock
MCASP_enableHclk(hMcas, MCASP_XMTRCV); //Wakes up transmit
                                         and receive high clock
MCASP_enableHclk(hMcas, MCASP_RCVXMT); //Wakes up receive and
                                         transmit high clock
```

MCASP_enableSers *Enables transmit and/or receive serializers, depending on direction*

Function	void MCASP_enableSers(MCASP_Handle hMcasp, Uint32 direction)
Arguments	hMcasp Handle to McASP device. See MCASP_open() direction direction of the serializers <input type="checkbox"/> MCASP_RCV <input type="checkbox"/> MCASP_XMT <input type="checkbox"/> MCASP_RCVXMT <input type="checkbox"/> MCASP_XMTRCV
Return Value	none
Description	This function wakes up the transmit or receive (or both) serializers out of reset by writing into RSRCLR and XSRCLR of GBLCTL.
Example	<pre> MCASP_Handle hMcasp; ... MCASP_enableSers(hMcasp, MCASP_RCV); //Receive serializers are made active MCASP_enableSers(hMcasp, MCASP_XMT); //Transmit serializers are made active MCASP_enableSers(hMcasp, MCASP_XMTRCV); //Transmit and receive serializers are made active MCASP_enableSers(hMcasp, MCASP_RCVXMT); //Receive and transmit serializers are made active </pre>

MCASP_enableSm

MCASP_enableSm *Wakes up transmit and/or receive state machine, depending on direction*

Function	<pre>void MCASP_enableSm(MCASP_Handle hMcas, Uint32 direction)</pre>
Arguments	<p>hMcas Handle to McASP device. See MCASP_open()</p> <p>direction direction of the state machine</p> <ul style="list-style-type: none"><input type="checkbox"/> MCASP_RCV<input type="checkbox"/> MCASP_XMT<input type="checkbox"/> MCASP_RCVXMT<input type="checkbox"/> MCASP_XMTRCV
Return Value	none
Description	This function wakes up the transmit or receive (or both) serializers out of reset by writing into RSMRST and XSMRST of GBLCTL.
Example	<pre>MCASP_Handle hMcas; ... MCASP_enableSm(hMcas, MCASP_RCV); //Wakes up receive state machine MCASP_enableSm(hMcas, MCASP_XMT); //Wakes up transmit state machine MCASP_enableSm(hMcas, MCASP_XMTRCV); //Wakes up transmit and receive state machine MCASP_enableSm(hMcas, MCASP_RCVXMT); //Wakes up receive and transmit state machine</pre>

MCASP_getConfig *Reads the current McASP configuration values*

Function void MCASP_getConfig(
 MCASP_Handle hMcasp,
 MCASP_Config *config
)

Arguments hMcasp Handle to McASP device. See MCASP_open ()
 config Pointer to the source configuration structure

Return Value none

Description This function gets the current McASP configuration values, as configured in the Global, Receive, Transmit, and Serial Control registers. See MCASP_config().

Example MCASP_Config mcaspCfg;
 ...
 MCASP_getConfig(hMcasp, &mcaspCfg);

MCASP_getGblctl *Reads GBLCTL register, depending on the direction*

Function Uint32 MCASP_getGblctl(
 MCASP_Handle hMcasp,
 Uint32 direction
)

Arguments hMcasp Handle to McASP device. See MCASP_open ()
 direction direction
 MCASP_RCV
 MCASP_XMT
 MCASP_RCVXMT
 MCASP_XMTRCV

Return Value Uint32 Returns GBCTL, depending on direction

Description This function returns the XGBLCTL value for MCASP_XMT direction, and the RGBLCTL value for MCASP_RCV direction. It returns GBLCTL otherwise.

Example MCASP_Handle hMcasp;
 Uint32 gblVal;
 hMcasp = MCASP_open(MCASP_DEV0, MCASP_OPEN_RESET);
 ...
 gblVal = MCASP_getGblctl(hMcasp, MCASP_RCV); //RGBLCTL
 gblVal = MCASP_getGblctl(hMcasp, MCASP_XMT); //XGBLCTL
 gblVal = MCASP_getGblctl(hMcasp, MCASP_XMTRCV); //GBLCTL

MCASP_read32Cfg

MCASP_read32Cfg *Reads the data from rbufNum*

Function	<pre>Uint32 MCASP_read32Cfg(MCASP_Handle hMcasp, Uint32 rbufNum);</pre>
Arguments	<pre>hMcasp Handle to McASP device. See MCASP_open() rbufNum RBUF[0:15]</pre>
Return Value	<pre>Uint32 Returns data in RBUF[rbufNum]</pre>
Description	This function reads data from RBUF[0:15]. It should be used only when the corresponding AXR[0:15] is configured as a receiver and the receiver uses the peripheral configuration bus.
Example	<pre>MCASP_Handle hMcasp; Uint32 val; ... val = MCASP_read32Cfg(hMcasp,9); // Read data from RBUF9, which is configured as receiver</pre>

MCASP_resetRcv *Resets the receiver fields in the Global Control register*

Function	<pre>Uint32void MCASP_resetRcv(MCASP_Handle hMcasp);</pre>
Arguments	<pre>hMcasp Handle to McASP device. See MCASP_open()</pre>
Return Value	<pre>none</pre>
Description	<p>This function resets the state machine, clears the serial buffer, resets the frame synchronization generator, and resets clocks for the receiver. That is, it clears the RSRCLR, RSMRST, RFRST, RCLKRST, and RHCLKRST in GBLCTL.</p> <p>Note: It takes 32 receive clock cycles for GBLCTL to update.</p>
Example	<pre>MCASP_Handle hMcasp; hMcasp = MCASP_open(MCASP_DEV0, MCASP_OPEN_RESET); ... MCASP_resetRcv(hMcasp);</pre>

MCASP_resetXmt *Resets the transmitter fields in the Global Control register*

Function `Uint32void MCASP_resetXmt(
 MCASP_Handle hMcas
);`

Arguments `hMcas` Handle to McASP device. See `MCASP_open()`

Return Value none

Description This function resets the state machine, clears the serial buffer, resets the frame synchronization generator, and resets clocks for the transmitter. That is, it clears the XSRCLR, XSMRST, XFRST, XCLKRST, and XHCLKRST in GBLCTL.

Note: It takes 32 transmit clock cycles for GBLCTL to update.

Example

```
MCASP_Handle hMcas;
hMcas = MCASP_open(MCASP_DEV0, MCASP_OPEN_RESET);
...
MCASP_resetXmt(hMcas);
```

MCASP_setPins *Sets pins which are enabled as GPIO and output*

Function `void MCASP_setPins(
 MCASP_Handle hMcas,
 Uint32 pins
)`

Arguments `hMcas` Handle to McASP device. See `MCASP_open()`
 `pins` Mask value for the pins

Return Value none

Description This function sets up the the PDSET register with the mask value pins specified in 'pins'. This function is used for those McASP pins which are configured as GPIO and are in output direction. Writing a 1 sets the corresponding bit in PDOUT as 1. Writing a 0 leaves it unchanged. The PDSET register is an alias of the PDOUT register.

Example

```
MCASP_Handle hMcas;
...
MCASP_setPins(hMcas, 0x101); // Sets bits 0,4 in PDOUT
```

MCASP_setupClk

MCASP_setupClk *Sets up McASP transmit and receive clock registers*

Function	<pre>void MCASP_setupClk(MCASP_Handle hMcaspl, MCASP_SetupClk *setupclk)</pre>
Arguments	<pre>hMcaspl Handle to McASP device. See MCASP_open() setupclk Pointer to the configuration structure</pre>
Return Value	none
Description	This function configures the McASP device clock registers using the configuration structure <code>MCASP_SetupClk</code> . The values of the structure members are written to McASP transmit and receive clock registers.
Example	<pre>MCASP_SetupClk setupclk; ... MCASP_setupClk(hMcaspl, &setupclk);</pre>

MCASP_setupFormat *Sets up McASP transmit and receive format registers*

Function	<pre>void MCASP_setupFormat(MCASP_Handle hMcaspl, MCASP_SetupFormat *setupformat)</pre>
Arguments	<pre>hMcaspl Handle to McASP device. See MCASP_open() setupformat Pointer to the configuration structure</pre>
Return Value	none
Description	This function configures the McASP device format registers using the configuration structure <code>MCASP_SetupFormat</code> . The values of the structure members are written to McASP transmit and receive format registers.
Example	<pre>MCASP_SetupFormat setupformat; ... MCASP_setupFormat(hMcaspl, &setupformat);</pre>

MCASP_setupFsync *Sets up McASP transmit and receive frame sync registers*

Function void MCASP_setupFsync(
 MCASP_Handle hMcasp,
 MCASP_SetupFsync *setupfsync
)

Arguments hMcasp Handle to McASP device. See MCASP_open()
 setupfsync Pointer to the configuration structure

Return Value none

Description This function configures the McASP device frame sync registers using the configuration structure MCASP_SetupFsync. The values of the structure members are written to McASP transmit and receive frame sync registers.

Example

```
MCASP_SetupFsync setupfsync;
...
MCASP_setupFsync(hMcasp, &setupfsync);
```

MCASP_setupHclk *Sets up McASP transmit and receive high clock registers*

Function void MCASP_setupHclk(
 MCASP_Handle hMcasp,
 MCASP_SetupHclk *setuphclk
)

Arguments hMcasp Handle to McASP device. See MCASP_open()
 setuphclk Pointer to the configuration structure

Return Value none

Description This function configures the McASP device high clock registers using the configuration structure MCASP_SetupHclk. The values of the structure members are written to McASP transmit and receive high clock registers.

Example

```
MCASP_SetupHclk setuphclk;
...
MCASP_setupHclk(hMcasp, &setuphclk);
```

MCASP_write32Cfg

MCASP_write32Cfg *Writes the val into xbufNum*

Function	<pre>void MCASP_write32Cfg(MCASP_Handle hMcas, Uint32 xbufNum, Uint32 val);</pre>
Arguments	<pre>hMcas Handle to McASP device. See MCASP_open() xbufNum XBUF[0:15] val Value to be transmitted</pre>
Return Value	none
Description	This function writes data into XBUF[0:15]. It should be used only when the corresponding AXR[0:15] is configured as a transmitter and the transmitter uses the peripheral configuration bus.
Example	<pre>MCASP_Handle hMcas; ... MCASP_write32Cfg(hMcas,4); // Write data into XBUF4, which is configured as transmitter</pre>

15.4.4 Interrupt Control Functions

MCASP_getRcvEventId *Returns the receive event ID*

Function	<pre>Uint32 MCASP_getRcvEventId(MCASP_Handle hMcas);</pre>
Arguments	<pre>hMcas Handle to McASP device. See MCASP_open()</pre>
Return Value	Uint32 Receiver event ID
Description	Retrieves the receive event ID for the given device.
Example	<pre>MCASP_Handle hMcas Uint32 eventNo; hMcas = MCASP_open(MCASP_DEV0, MCASP_OPEN_RESET); ... eventNo = MCASP_getRcvEventId(hMcas);</pre>

MCASP_getXmtEventId *Returns the transmit event ID*

Function	UInt32 MCASP_getXmtEventId(MCASP_Handle hMcasp);
Arguments	hMcasp Handle to McASP device. See MCASP_open ()
Return Value	UInt32 Transmit event ID
Description	Retrieves the transmit event ID for the given device.
Example	<pre>MCASP_Handle hMcasp UInt32 eventNo; hMcasp = MCASP_open(MCASP_DEV0, MCASP_OPEN_RESET); ... eventNo = MCASP_getXmtEventId(hMcasp);</pre>



McBSP Module

This chapter describes the McBSP module, lists the API functions and macros within the module, discusses using a McBSP port, and provides a McBSP API reference section.

Topic	Page
16.1 Overview	16-2
16.2 Macros	16-5
16.3 Configuration Structure	16-7
16.4 Functions	16-9

16.1 Overview

The McBSP module contains a set of API functions for configuring the McBSP registers.

Table 16–1 lists the configuration structure for use with the McBSP functions. Table 16–2 lists the functions and constants available in the CSL McBSP module.

Table 16–1. McBSP Configuration Structure

Syntax	Type	Description	See page ...
MCBSP_Config	S	Used to setup a McBSP port	16-7

Table 16–2. McBSP APIs

(a) Primary Functions

Syntax	Type	Description	See page ...
MCBSP_close	F	Closes a McBSP port previously opened via MCBSP_open ()	16-9
MCBSP_config	F	Sets up the McBSP port using the configuration structure	16-9
MCBSP_configArgs	F	Sets up the McBSP port using the register values passed in	16-11
MCBSP_open	F	Opens a McBSP port for use	16-13
MCBSP_start	F	Starts the McBSP device	16-14

(b) Auxiliary Functions and Constants

Syntax	Type	Description	See page ...
MCBSP_enableFsync	F	Enables the frame sync generator for the given port	16-15
MCBSP_enableRcv	F	Enables the receiver for the given port	16-15
MCBSP_enableSgr	F	Enables the sample rate generator for the given port	16-16
MCBSP_enableXmt	F	Enables the transmitter for the given port	16-16
MCBSP_getConfig	F	Reads the current McBSP configuration values	16-16
MCBSP_getPins	F	Reads the values of the port pins when configured as general purpose I/Os	16-17

Note: F = Function; C = Constant

Table 16–2. McBSP APIs (Continued)

Syntax	Type	Description	See page ...
MCBSP_getRcvAddr	F	Returns the address of the data receive register (DRR)	16-17
MCBSP_getXmtAddr	F	Returns the address of the data transmit register, DXR	16-18
MCBSP_PORT_CNT	C	A compile time constant that holds the number of serial ports present on the current device	16-18
MCBSP_read	F	Performs a direct 32-bit read of the data receive register DRR	16-18
MCBSP_reset	F	Resets the given serial port	16-19
MCBSP_resetAll	F	Resets all serial ports supported by the device	16-19
MCBSP_rfull	F	Reads the RFULL bit of the serial port control register	16-19
MCBSP_rrdy	F	Reads the RRDY status bit of the SPCR register	16-20
MCBSP_rsyncerr	F	Reads the RSYNCERR status bit of the SPCR register	16-20
MCBSP_setPins	F	Sets the state of the serial port pins when configured as general purpose IO	16-21
MCBSP_SUPPORT	C	A compile time constant whose value is 1 if the device supports the McBSP module	16-21
MCBSP_write	F	Writes a 32-bit value directly to the serial port data transmit register, DXR	16-22
MCBSP_xempty	F	Reads the XEMPTY bit from the SPCR register	16-22
MCBSP_xrdy	F	Reads the XRDY status bit of the SPCR register	16-22
MCBSP_xsyncerr	F	Reads the XSYNCERR status bit of the SPCR register	16-23

(c) Interrupt Control Functions

Syntax	Type	Description	See page ...
MCBSP_getRcvEventId	F	Retrieves the receive event ID for the given port	16-23
MCBSP_getXmtEventId	F	Retrieves the transmit event ID for the given port	16-24

Note: F = Function; C = Constant

16.1.1 Using a McBSP Port

To use a McBSP port, you must first open it and obtain a device handle using `MCBSP_open()`. Once opened, use the device handle to call the other API functions. The port may be configured by passing a `MCBSP_Config` structure to `MCBSP_config()` or by passing register values to the `MCBSP_configArgs()` function. To assist in creating register values, the *MCBSP_MK* (make) macros construct register values based on field values. In addition, the symbol constants may be used for the field values.

There are functions for directly reading and writing to the data registers DRR and DXR, `MCBSP_read()` and `MCBSP_write()`. The addresses of the DXR and DRR registers are also obtainable for use with DMA configuration, `MCBSP_getRcvAddr()` and `MCBSP_getXmtAddr()`.

McBSP status bits are easily read using efficient inline functions.

16.2 Macros

There are two types of McBSP macros: those that access registers and fields, and those that construct register and field values.

Table 16–3 lists the McBSP macros that access registers and fields, and Table 16–4 lists the McBSP macros that construct register and field values. The macros themselves are found in Chapter 28, *Using the HAL Macros*.

The McBSP module includes handle-based macros.

Table 16–3. McBSP Macros that Access Registers and Fields

Macro	Description/Purpose	See page ...
MCBSP_ADDR(<REG>)	Register address	28-12
MCBSP_RGET(<REG>)	Returns the value in the peripheral register	28-18
MCBSP_RSET(<REG>,x)	Register set	28-20
MCBSP_FGET(<REG>,<FIELD>)	Returns the value of the specified field in the peripheral register	28-13
MCBSP_FSET(<REG>,<FIELD>,fieldval)	Writes <i>fieldval</i> to the specified field in the peripheral register	28-15
MCBSP_FSETS(<REG>,<FIELD>,<SYM>)	Writes the symbol value to the specified field in the peripheral	28-17
MCBSP_RGETA(addr,<REG>)	Gets register for a given address	28-19
MCBSP_RSETA(addr,<REG>,x)	Sets register for a given address	28-20
MCBSP_FGETA(addr,<REG>,<FIELD>)	Gets field for a given address	28-13
MCBSP_FSETA(addr,<REG>,<FIELD>,fieldval)	Sets field for a given address	28-16
MCBSP_FSETSA(addr,<REG>,<FIELD>,<SYM>)	Sets field symbolically for a given address	28-17
MCBSP_ADDRH(h,<REG>)	Returns the address of a memory-mapped register for a given handle	28-12
MCBSP_RGETH(h,<REG>)	Returns the value of a register for a given handle	28-19
MCBSP_RSETH(h,<REG>,x)	Sets the register value to x for a given handle	28-21
MCBSP_FGETH(h,<REG>,<FIELD>)	Returns the value of the field for a given handle	28-14
MCBSP_FSETH(h,<REG>,<FIELD>,fieldval)	Sets the field value to x for a given handle	28-16

Table 16–4. McBSP Macros that Construct Register and Field Values

Macro	Description/Purpose	See page ...
MCBSP_<REG>_DEFAULT	Register default value	28-21
MCBSP_<REG>_RMK()	Register make	28-23
MCBSP_<REG>_OF()	Register value of ...	28-22
MCBSP_<REG>_<FIELD>_DEFAULT	Field default value	28-24
MCBSP_FMKS()	Field make	28-14
MCBSP_FMKS()	Field make symbolically	28-15
MCBSP_<REG>_<FIELD>_OF()	Field value of ...	28-24
MCBSP_<REG>_<FIELD>_<SYM>	Field symbolic value	28-24

16.3 Configuration Structure

MCBSP_Config *Used to setup McBSP port*

Structure MCBSP_Config

Members

UInt32 spcr	Serial port control register value
UInt32 rcr	Receive control register value
UInt32 xcr	Transmit control register value
UInt32 srgr	Sample rate generator register value
UInt32 mcr	Multichannel control register value
UInt32 rcer	Receive channel enable register value
UInt32 xcer	Transmit channel enable register value
UInt32 pcr	Pin control register value

Configuration structure for C64x devices only:

UInt32 spcr	Serial port control register value
UInt32 rcr	Receive control register value
UInt32 xcr	Transmit control register value
UInt32 srgr	Sample rate generator register value
UInt32 mcr	Multichannel control register value
UInt32 rcere0	Enhanced Receive channel enable register 0 value
UInt32 rcere1	Enhanced Receive channel enable register 1 value
UInt32 rcere2	Enhanced Receive channel enable register 2 value
UInt32 rcere3	Enhanced Receive channel enable register 3 value
UInt32 xcere0	Enhanced Transmit channel enable register 0 value
UInt32 xcere1	Enhanced Transmit channel enable register 1 value
UInt32 xcere2	Enhanced Transmit channel enable register 2 value
UInt32 xcere3	Enhanced Transmit channel enable register 3 value
UInt32 pcr	Pin Control register value

Description This is the McBSP configuration structure used to set up a McBSP port. You create and initialize this structure and then pass its address to the `MCBSP_config()` function. You can use literal values or the `MCBSP_RMK` macros to create the structure member values.

MCBSP_Config

Example

```
MCBSP_Config MyConfig = {
    0x00012001, /* spcr */
    0x00010140, /* rcr  */
    0x00010140, /* xcr  */
    0x00000000, /* srgr */
    0x00000000, /* mcr  */
    0x00000000, /* rcer */
    0x00000000, /* xcer */
    0x00000000 /* pcr  */
};
...
MCBSP_config(hMcbasp, &MyConfig);
```

/ Configuration structure for C64x devices only */*

```
MCBSP_Config MyConfig = {
    0x00012001, /* spcr ..*/
    0x00010140, /* rcr  ..*/
    0x00010140, /* xcr  ..*/
    0x00000000, /* srgr ..*/
    0x00000000, /* mcr  ..*/
    0x00000000, /* rcere0 */
    0x00000000, /* rcere1 */
    0x00000000, /* rcere2 */
    0x00000000, /* rcere3 */
    0x00000000, /* xcere0 */
    0x00000000, /* xcere1 */
    0x00000000, /* xcere2 */
    0x00000000, /* xcere3 */
    0x00000000 /* pcr  ..*/
};
...
MCBSP_config(hMcbasp, &MyConfig);
```

16.4 Functions

16.4.1 Primary Functions

MCBSP_close *Closes McBSP port previously opened via MCBSP_open()*

Function	void MCBSP_close(MCBSP_Handle hMcbasp);
Arguments	hMcbasp Handle to McBSP port, see MCBSP_open()
Return Value	none
Description	This function closes a McBSP port previously opened via MCBSP_open(). The registers for the McBSP port are set to their power-on defaults. Any associated interrupts are disabled and cleared.
Example	MCBSP_close(hMcbasp);

MCBSP_config *Sets up McBSP port using configuration structure*

Function	void MCBSP_config(MCBSP_Handle hMcbasp, MCBSP_Config *Config);
Arguments	hMcbasp Handle to McBSP port. See MCBSP_open() Config Pointer to an initialized configuration structure
Return Value	none
Description	Sets up the McBSP port using the configuration structure. The values of the structure are written to the port registers. The serial port control register (<i>spcr</i>) is written last. See also MCBSP_configArgs() and MCBSP_Config.

MCBSP_config

Example

```
#if (!C64_SUPPORT)
MCBSP_Config MyConfig = {
    0x00012001, /* spcr */
    0x00010140, /* rcr  */
    0x00010140, /* xcr  */
    0x00000000, /* srgr */
    0x00000000, /* mcr  */
    0x00000000, /* rcrc */
    0x00000000, /* xcrc */
    0x00000000 /* pcr  */
};
#else

/* Configuration structure for C64x devices only */
MCBSP_Config MyConfig = {
    0x00012001, /* spcr */
    0x00010140, /* rcr  */
    0x00010140, /* xcr  */
    0x00000000, /* srgr */
    0x00000000, /* mcr  */
    0x00000000, /* rcere0 */
    0x00000000, /* rcere1 */
    0x00000000, /* rcere2 */
    0x00000000, /* rcere3 */
    0x00000000, /* xcere0 */
    0x00000000, /* xcere1 */
    0x00000000, /* xcere2 */
    0x00000000, /* xcere3 */
    0x00000000 /* pcr  */
};
#endif
...
MCBSP_config(hMcbasp, &MyConfig);
```

MCBSP_configArgs *Sets up McBSP port using register values passed in*

Function	<pre> void MCBSP_configArgs(MCBSP_Handle hMcbbsp, Uint32 sPCR, Uint32 rCR, Uint32 xCR, Uint32 srGR, Uint32 mCR, Uint32 rcER, Uint32 xcER, Uint32 pCR); </pre> <p>For C64x devices:</p> <pre> void MCBSP_configArgs(MCBSP_Handle hMcbbsp, Uint32 sPCR, Uint32 rCR, Uint32 xCR, Uint32 srGR, Uint32 mCR, Uint32 rcERE0, Uint32 rcERE1, Uint32 rcERE2, Uint32 rcERE3, Uint32 xcERE0, Uint32 xcERE1, Uint32 xcERE2, Uint32 xcERE3, Uint32 pCR); </pre>																		
Arguments	<table border="0"> <tr> <td style="padding-right: 10px;">hMcbbsp</td> <td>Handle to McBSP port. See <code>MCBSP_open()</code></td> </tr> <tr> <td>sPCR</td> <td>Serial port control register value</td> </tr> <tr> <td>rCR</td> <td>Receive control register value</td> </tr> <tr> <td>xCR</td> <td>Transmit control register value</td> </tr> <tr> <td>srGR</td> <td>Sample rate generator register value</td> </tr> <tr> <td>mCR</td> <td>Multichannel control register value</td> </tr> <tr> <td>rcER</td> <td>Receive channel enable register value</td> </tr> <tr> <td>xcER</td> <td>Transmit channel enable register value</td> </tr> <tr> <td>pCR</td> <td>Pin control register value</td> </tr> </table>	hMcbbsp	Handle to McBSP port. See <code>MCBSP_open()</code>	sPCR	Serial port control register value	rCR	Receive control register value	xCR	Transmit control register value	srGR	Sample rate generator register value	mCR	Multichannel control register value	rcER	Receive channel enable register value	xcER	Transmit channel enable register value	pCR	Pin control register value
hMcbbsp	Handle to McBSP port. See <code>MCBSP_open()</code>																		
sPCR	Serial port control register value																		
rCR	Receive control register value																		
xCR	Transmit control register value																		
srGR	Sample rate generator register value																		
mCR	Multichannel control register value																		
rcER	Receive channel enable register value																		
xcER	Transmit channel enable register value																		
pCR	Pin control register value																		

MCBSP_configArgs

For C64x devices:

rcere0	Enhanced Receive channel enable register 0 value
rcere1	Enhanced Receive channel enable register 1 value
rcere2	Enhanced Receive channel enable register 2 value
rcere3	Enhanced Receive channel enable register 3 value
xcere0	Enhanced Transmit channel enable register 0 value
xcere1	Enhanced Transmit channel enable register 1 value
xcere2	Enhanced Transmit channel enable register 2 value
xcere3	Enhanced Transmit channel enable register 3 value

Return Value none

Description Sets up the McBSP port using the register values passed in. The register values are written to the port registers. The serial port control register (*sPCR*) is written last. See also `MCBSP_config()`.

You may use literal values for the arguments or for readability. You may use the *_RMK* macros to create the register values based on field values.

Example

```
MCBSP_configArgs(hMcbSP,  
    0x00012001, /* sPCR */  
    0x00010140, /* rCR  */  
    0x00010140, /* xCR  */  
    0x00000000, /* srgr */  
    0x00000000, /* mcr  */  
    0x00000000, /* rcer */  
    0x00000000, /* xcer */  
    0x00000000 /* pcr  */  
);  
  
/* C64x devices */
```

```

MCBSP_configArgs(hMcbasp,
    0x00012001, /* spcr */
    0x00010140, /* rcr  */
    0x00010140, /* xcr  */
    0x00000000, /* srgr */
    0x00000000, /* mcr  */
    0x00000000, /* rcere0 */
    0x00000000, /* rcere1 */
    0x00000000, /* rcere2 */
    0x00000000, /* rcere3 */
    0x00000000, /* xcere0 */
    0x00000000, /* xcere1 */
    0x00000000, /* xcere2 */
    0x00000000, /* xcere3 */
    0x00000000 /* pcr  */
);

```

MCBSP_open *Opens McBSP port for use*

Function	MCBSP_Handle MCBSP_open(int devNum, Uint32 flags);
Arguments	devNum McBSP device (port) number: <input type="checkbox"/> MCBSP_DEV0 <input type="checkbox"/> MCBSP_DEV1 <input type="checkbox"/> MCBSP_DEV2 (if supported by the C64x device) flags Open flags; may be logical OR of any of the following: <input type="checkbox"/> MCBSP_OPEN_RESET
Return Value	Device Handle Returns a device handle
Description	Before a McBSP port can be used, it must first be opened by this function. Once opened, it cannot be opened again until closed. See MCBSP_close(). The return value is a unique device handle that you use in subsequent McBSP API calls. If the open fails, INV is returned. If the MCBSP_OPEN_RESET is specified, the McBSP port registers are set to their power-on defaults and any associated interrupts are disabled and cleared.
Example	<pre> MCBSP_Handle hMcbasp; ... hMcbasp = MCBSP_open(MCBSP_DEV0, MCBSP_OPEN_RESET); </pre>

MCBSP_start

MCBSP_start

Starts McBSP device

Function	<pre>void MCBSP_start(MCBSP_Handle hMcbasp, Uint32 startMask, Uint32 SampleRateGenDelay);</pre>						
Arguments	<table><tr><td>hMcbasp</td><td>Handle to McBSP port. See <code>MCBSP_open()</code></td></tr><tr><td>startMask</td><td>Allows setting of the different start fields using the following macros:<ul style="list-style-type: none"><input type="checkbox"/> <code>MCBSP_XMIT_START</code>: start transmit (XRST)<input type="checkbox"/> <code>MCBSP_RCV_START</code>: start receive (RRST)<input type="checkbox"/> <code>MCBSP_SRGR_START</code>: start Sample rate generator (GRST)<input type="checkbox"/> <code>MCBSP_SRGR_FRAMESYNC</code>: Start frame sync. Generation (FRST)</td></tr><tr><td>SampleRateGenDelay</td><td>Sample rate generated delay. McBSP logic requires two SRGR clock periods after enabling the sample rate generator for its logic to stabilize. Use this parameter to provide the appropriate delay. Value = $2 \times \text{SRGR clock period} / 4 \times \text{C6x Instruction cycle}$ Default value is <code>0xFFFFFFFF</code></td></tr></table>	hMcbasp	Handle to McBSP port. See <code>MCBSP_open()</code>	startMask	Allows setting of the different start fields using the following macros: <ul style="list-style-type: none"><input type="checkbox"/> <code>MCBSP_XMIT_START</code>: start transmit (XRST)<input type="checkbox"/> <code>MCBSP_RCV_START</code>: start receive (RRST)<input type="checkbox"/> <code>MCBSP_SRGR_START</code>: start Sample rate generator (GRST)<input type="checkbox"/> <code>MCBSP_SRGR_FRAMESYNC</code>: Start frame sync. Generation (FRST)	SampleRateGenDelay	Sample rate generated delay. McBSP logic requires two SRGR clock periods after enabling the sample rate generator for its logic to stabilize. Use this parameter to provide the appropriate delay. Value = $2 \times \text{SRGR clock period} / 4 \times \text{C6x Instruction cycle}$ Default value is <code>0xFFFFFFFF</code>
hMcbasp	Handle to McBSP port. See <code>MCBSP_open()</code>						
startMask	Allows setting of the different start fields using the following macros: <ul style="list-style-type: none"><input type="checkbox"/> <code>MCBSP_XMIT_START</code>: start transmit (XRST)<input type="checkbox"/> <code>MCBSP_RCV_START</code>: start receive (RRST)<input type="checkbox"/> <code>MCBSP_SRGR_START</code>: start Sample rate generator (GRST)<input type="checkbox"/> <code>MCBSP_SRGR_FRAMESYNC</code>: Start frame sync. Generation (FRST)						
SampleRateGenDelay	Sample rate generated delay. McBSP logic requires two SRGR clock periods after enabling the sample rate generator for its logic to stabilize. Use this parameter to provide the appropriate delay. Value = $2 \times \text{SRGR clock period} / 4 \times \text{C6x Instruction cycle}$ Default value is <code>0xFFFFFFFF</code>						
Return Value	none						
Description	Use this function to start a transmit and/or receive operation for a McBSP port by passing the handle and mask. Equivalent to <code>MCBSP_enableXmt()</code> , <code>MCBSP_enableRcv()</code> , <code>MCBSP_enableSrgr()</code> , and <code>MCBSP_enableFsync()</code> .						
Example	<pre>MCBSP_start(hMcbasp, MCBSP_RCV_START, 0x00003000); MCBSP_start(hMcbasp, MCBSP_RCV_START MCBSP_XMT_START, 0x00003000);</pre>						

16.4.2 Auxiliary Functions and Constants

MCBSP_enableFsync *Enables frame sync generator for given port*

Function	void MCBSP_enableFsync(MCBSP_Handle hMcbasp);
Arguments	hMcbasp Handle to McBSP port. See MCBSP_open ()
Return Value	none
Description	Use this function to enable the frame sync generator for the given port.
Example	MCBSP_enableFsync (hMcbasp) ;

MCBSP_enableRcv *Enables receiver for given port*

Function	void MCBSP_enableRcv(MCBSP_Handle hMcbasp);
Arguments	hMcbasp Handle to McBSP port. See MCBSP_open ()
Return Value	none
Description	Use this function to enable the receiver for the given port.
Example	MCBSP_enableRcv (hMcbasp) ;

MCBSP_enableSrgr

MCBSP_enableSrgr *Enables sample rate generator for given port*

Function	<code>void MCBSP_enableSrgr(MCBSP_Handle hMcbasp);</code>
Arguments	<code>hMcbasp</code> Handle to McBSP port. See <code>MCBSP_open()</code>
Return Value	none
Description	Use this function to enable the sample rate generator for the given port.
Example	<code>MCBSP_enableSrgr(hMcbasp);</code>

MCBSP_enableXmt *Enables transmitter for given port*

Function	<code>void MCBSP_enableXmt(MCBSP_Handle hMcbasp);</code>
Arguments	<code>hMcbasp</code> Handle to McBSP port. See <code>MCBSP_open()</code>
Return Value	none
Description	Use this function to enable the transmitter for the given port.
Example	<code>MCBSP_enableXmt(hMcbasp);</code>

MCBSP_getConfig *Reads the current McBSP configuration values*

Function	<code>void MCBSP_getConfig(MCBSP_Handle hMcbasp, MCBSP_Config *config);</code>
Arguments	<code>hMcbasp</code> Handle to McBSP port. See <code>MCBSP_open()</code> <code>config</code> Pointer to a configuration structure.
Return Value	none
Description	Get McBSP current configuration value
Example	<code>MCBSP_config mcbaspCfg; MCBSP_getConfig(hMcbasp, &mcbaspCfg);</code>

MCBSP_getPins *Reads values of port pins when configured as general purpose I/Os*

Function	<pre> Uint32 MCBSP_getPins(MCBSP_Handle hMcbasp); </pre>
Arguments	<p>hMcbasp Handle to McBSP port. See MCBSP_open ()</p>
Return Value	<p>Pin Mask Bit-Mask of pin values</p> <ul style="list-style-type: none"> <input type="checkbox"/> MCBSP_PIN_CLKX <input type="checkbox"/> MCBSP_PIN_FSX <input type="checkbox"/> MCBSP_PIN_DX <input type="checkbox"/> MCBSP_PIN_CLKR <input type="checkbox"/> MCBSP_PIN_FSR <input type="checkbox"/> MCBSP_PIN_DR <input type="checkbox"/> MCBSP_PIN_CLKS
Description	<p>This function reads the values of the port pins when configured as general purpose input/outputs.</p>
Example	<pre> Uint32 PinMask; ... PinMask = MCBSP_getPins(hMcbasp); if (PinMask & MCBSP_PIN_DR) { ... } </pre>

MCBSP_getRcvAddr *Returns address of data receive register (DRR)*

Function	<pre> Uint32 MCBSP_getRcvAddr(MCBSP_Handle hMcbasp); </pre>
Arguments	<p>hMcbasp Handle to McBSP port. See MCBSP_open ()</p>
Return Value	<p>Receive Address DRR register address</p>
Description	<p>Returns the address of the data receive register, DRR. This value is needed when setting up DMA transfers to read from the serial port. See also MCBSP_getXmtAddr ().</p>
Example	<pre> Addr = MCBSP_getRcvAddr(hMcbasp); </pre>

MCBSP_getXmtAddr

MCBSP_getXmtAddr *Returns address of data transmit register, DXR*

Function	Uint32 MCBSP_getXmtAddr(MCBSP_Handle hMcbasp);
Arguments	hMcbasp Handle to McBSP port. See MCBSP_open ()
Return Value	Transmit Address DXR register address
Description	Returns the address of the data transmit register, DXR. This value is needed when setting up DMA transfers to write to the serial port. See also MCBSP_getRcvAddr ().
Example	<pre>Addr = MCBSP_getXmtAddr(hMcbasp);</pre>

MCBSP_PORT_CNT *Compile-time constant*

Constant	MCBSP_PORT_CNT
Description	Compile-time constant that holds the number of serial ports present on the current device.
Example	<pre>#if (MCBSP_PORT_CNT==3) ... #endif</pre>

MCBSP_read *Performs direct 32-bit read of data receive register DRR*

Function	Uint32 MCBSP_read(MCBSP_Handle hMcbasp);
Arguments	hMcbasp Handle to McBSP port. See MCBSP_open ()
Return Value	Data
Description	This function performs a direct 32-bit read of the data receive register DRR.
Example	<pre>Data = MCBSP_read(hMcbasp);</pre>

MCBSP_reset *Resets given serial port*

Function	void MCBSP_reset(MCBSP_Handle hMcbasp);
Arguments	hMcbasp Handle to McBSP port. See MCBSP_open ()
Return Value	none
Description	Resets the given serial port. Actions Taken: <input type="checkbox"/> All serial port registers are set to their power-on defaults. The PCR register will be reset to the McBSP reset value and not the device reset value <input type="checkbox"/> All associated interrupts are disabled and cleared
Example	MCBSP_reset (hMcbasp) ;

MCBSP_resetAll *Resets all serial ports supported by the chip device*

Function	void MCBSP_resetAll();
Arguments	none
Return Value	none
Description	Resets all serial ports supported by the chip device Executed Actions: <input type="checkbox"/> All serial port registers are set to their power-on defaults. The PCR register will be reset to the McBSP reset value and not the device reset value <input type="checkbox"/> All associated interrupts are disabled and cleared
Example	MCBSP_resetAll () ;

MCBSP_rfull *Reads RFULL bit of serial port control register*

Function	Uint32 MCBSP_rfull(MCBSP_Handle hMcbasp);
Arguments	hMcbasp Handle to McBSP port. See MCBSP_open ()

MCBSP_rrdy

Return Value	RFULL Returns RFULL status bit of SPCR register; 0 or 1
Description	This function reads the RFULL bit of the serial port control register. A 1 indicates a receive shift register full error.
Example	<pre>if (MCBSP_rfull(hMcbbsp)) { ... }</pre>

MCBSP_rrdy *Reads RRDY status bit of SPCR register*

Function	UInt32 MCBSP_rrdy(MCBSP_Handle hMcbbsp);
Arguments	hMcbbsp Handle to McBSP port. See MCBSP_open()
Return Value	RRDY Returns RRDY status bit of SPCR; 0 or 1
Description	Reads the RRDY status bit of the SPCR register. A 1 indicates the receiver is ready with data to be read.
Example	<pre>if (MCBSP_rrdy(hMcbbsp)) { ... }</pre>

MCBSP_rsyncerr *Reads RSYNCERR status bit of SPCR register*

Function	UInt32 MCBSP_rsyncerr(MCBSP_Handle hMcbbsp);
Arguments	hMcbbsp Handle to McBSP port. See MCBSP_open()
Return Value	RSYNCERR Returns RSYNCERR bit of the SPCR register; 0 or 1
Description	Reads the RSYNCERR status bit of the SPCR register. A 1 indicates a receiver frame sync error.
Example	<pre>if (MCBSP_rsyncerr(hMcbbsp)) { ... }</pre>

MCBSP_setPins *Sets state of serial port pins when configured as general purpose IO*

Function	void MCBSP_setPins(MCBSP_Handle hMcbasp, Uint32 pins);
Arguments	hMcbasp Handle to McBSP port. See MCBSP_open () pins Bit-mask of pin values (logical OR) <input type="checkbox"/> MCBSP_PIN_CLKX <input type="checkbox"/> MCBSP_PIN_F SX <input type="checkbox"/> MCBSP_PIN_DX <input type="checkbox"/> MCBSP_PIN_CLKR <input type="checkbox"/> MCBSP_PIN_FSR <input type="checkbox"/> MCBSP_PIN_DR <input type="checkbox"/> MCBSP_PIN_CLKS
Return Value	none
Description	Use this function to set the state of the serial port pins when configured as general purpose IO.
Example	<pre>MCBSP_setPins(hMcbasp, MCBSP_PIN_F SX MCBSP_PIN_DX);</pre>

MCBSP_SUPPORT *Compile-time constant*

Constant	MCBSP_SUPPORT
Description	Compile-time constant that has a value of 1 if the device supports the McBSP module and 0 otherwise. You are not required to use this constant. Currently, all devices support this module.
Example	<pre>#if (MCBSP_SUPPORT) /* user McBSP configuration / #endif</pre>

MCBSP_write

MCBSP_write *Writes 32-bit value directly to serial port data transmit register, DXR*

Function	<pre>void MCBSP_write(MCBSP_Handle hMcbasp, Uint32 val);</pre>
Arguments	<p>hMcbasp Handle to McBSP port. See <code>MCBSP_open()</code></p> <p>val 32-bit data value</p>
Return Value	none
Description	Use this function to directly write a 32-bit value to the serial port data transmit register, DXR.
Example	<pre>MCBSP_write(hMcbasp, 0x12345678);</pre>

MCBSP_xempty *Reads XEMPTY bit from SPCR register*

Function	<pre>Uint32 MCBSP_xempty(MCBSP_Handle hMcbasp);</pre>
Arguments	hMcbasp Handle to McBSP port. See <code>MCBSP_open()</code>
Return Value	XEMPTY Returns XEMPTY bit of SPCR register; 0 or 1
Description	Reads the XEMPTY bit from the SPCR register. A 0 indicates the transmit shift (XSR) is empty.
Example	<pre>if (MCBSP_xempty(hMcbasp)) { ... }</pre>

MCBSP_xrdy *Reads XRDY status bit of SPCR register*

Function	<pre>Uint32 MCBSP_xrdy(MCBSP_Handle hMcbasp);</pre>
Arguments	hMcbasp Handle to McBSP port. See <code>MCBSP_open()</code>
Return Value	XRDY Returns XRDY status bit of SPCR; 0 or 1

Description Reads the XRDY status bit of the SPCR register. A 1 indicates the transmitter is ready to be written to.

Example

```
if (MCBSP_xrdy(hMcbasp)) {
    ...
}
```

MCBSP_xsyncerr *Reads XSYNCERR status bit of SPCR register*

Function Uint32 MCBSP_xsyncerr(
 MCBSP_Handle hMcbasp
);

Arguments hMcbasp Handle to McBSP port. See MCBSP_open ()

Return Value XSYNCERR Returns XSYNCERR bit of the SPCR register; 0 or 1

Description Reads the XSYNCERR status bit of the SPCR register. A 1 indicates a transmitter frame sync error.

Example

```
if (MCBSP_xsyncerr(hMcbasp)) {
    ...
}
```

16.4.3 Interrupt Control Functions

MCBSP_getRcvEventId *Retrieves transmit event ID for given port*

Function Uint32 MCBSP_getRcvEventId(
 MCBSP_Handle hMcbasp
);

Arguments hMcbasp Handle to McBSP port. See MCBSP_open ()

Return Value Receive Event ID Receiver event ID

Description Retrieves the receive event ID for the given port.

Example

```
Uint32 RecvEventId;
...
RecvEventId = MCBSP_getRcvEventId(hMcbasp);
IRQ_enable(RecvEventId);
```

MCBSP_getXmtEventId

MCBSP_getXmtEventId *Retrieves transmit event ID for given port*

Function `Uint32 MCBSP_getXmtEventId(
 MCBSP_Handle hMcbp
);`

Arguments `hMcbp` Handle to McBSP port. See `MCBSP_open()`

Return Value Transmit Event ID Event ID of transmitter

Description Retrieves the transmit event ID for the given port.

Example `Uint32 XmtEventId;
 ...
 XmtEventId = MCBSP_getXmtEventId(hMcbp);
 IRQ_enable(XmtEventId);`

MDIO Module

This chapter describes the MDIO module, lists the API functions and macros within the module, and provides an MDIO reference section.

Topic	Page
17.1 Overview	17-2
17.2 Macros	17-3
17.3 Functions	17-4

17.1 Overview

The management data input/output (MDIO) module implements the 802.3 serial management interface to interrogate and control Ethernet PHY(s) using a shared two-wire bus. Host software uses the MDIO module to configure the auto-negotiation parameters of each PHY attached to the EMAC, retrieve the negotiation results, and configure required parameters in the EMAC module for correct operation. The module is designed to allow almost transparent operation of the MDIO interface, with very little maintenance from the core processor.

Table 17–1 lists the functions and constants available in the CSL MDIO module.

When used in a multitasking environment, no MDIO function may be called while another MDIO function is operating on the same device handle in another thread. It is the responsibility of the application to assure adherence to this restriction. When using the CSL EMAC module, the EMAC module makes use of this MDIO module. It is not necessary for the application to call any MDIO functions directly when the CSL EMAC module is in use. In the function descriptions, uint is defined as unsigned int and Handle as void*.

Table 17–1. MDIO Functions and Constants

Syntax	Type	Description	See page
MDIO_close	F	Close the MDIO peripheral and disables further operation	17-4
MDIO_getStatus	F	Called to get the status of the MDIO/PHY	17-4
MDIO_initPHY	F	Force a switch to the specified PHY, and start negotiation	17-5
MDIO_open	F	Opens the MDIO peripheral and starts searching for a PHY device	17-5
MDIO_phyRegRead	F	Raw data read of a PHY register	17-6
MDIO_phyRegWrite	F	Raw data write of a PHY register	17-6
MDIO_SUPPORT	C	A compile-time constant whose value is 1 if the device supports the MDIO module	17-7
MDIO_timerTick	F	Called to signify that approx 100mS have elapsed	17-7

17.2 Macros

There are two types of MDIO macros: those that access registers and fields, and those that construct register and field values. Table 17–2 lists the MDIO macros that access registers and fields, and Table 17–3 lists the MDIO macros that construct register and field values. The macros themselves are found in Chapter 28, *Using the HAL Macros*.

Table 17–2. MDIO Macros That Access Registers and Fields

Macro	Description/Purpose	See page
MDIO_ADDR(<REG>)	Register address	
MDIO_RGET(<REG>)	Returns the value in the peripheral register	
MDIO_RSET(<REG>,x)	Register set	
MDIO_FGET(<REG>,<FIELD>)	Returns the value of the specified field in the peripheral register	
MDIO_FSET(<REG>,<FIELD>,fieldval)	Writes fieldval to the specified field in the peripheral register	
MDIO_FSETS(<REG>,<FIELD>,<SYM>)	Writes the symbol value to the specified field in the peripheral	
MDIO_<REG>_<FIELD>_DEFAULT	Field default value	
MDIO_FMK()	Field make	
MDIO_FMKS()	Field make symbolically	
MDIO_<REG>_<FIELD>_<SYM>	Field symbolic value	

Table 17–3. MDIO Macros that Construct Register and Field Values

Macro	Description/Purpose	See page
-------	---------------------	----------

MDIO_close

17.3 Functions

MDIO_close *Close the MDIO peripheral and disables further operation*

Function	<code>void MDIO_close(Handle hMDIO);</code>
Arguments	Handle hMDIO
Return Value	None
Description	Closes the MDIO peripheral and disable further operation. See MDIO_open for more details
Example	<pre>Handle hMDIO; ... hMDIO = MDIO_open(0); MDIO_close(hMDIO);</pre>

MDIO_getStatus *Called to get the status of the MDIO/PHY*

Function	<code>void MDIO_getStatus(Handle hMDIO, uint *pPhy, uint *pLinkStatus);</code>
Arguments	Handle hMDIO uint *pPhy Pointer to store physical address uint *pLinkStatus Pointer to store Link Status
Return Value	None
Description	Called to get the status of the MDIO/PHY
Example	<pre>Handle hMDIO; uint *pPhy; uint *pLinkStatus; ... MDIO_getStatus(hMDIO, pPhy, pLinkStatus);</pre>

MDIO_initPHY *Force a switch to the specified PHY, and start negotiation*

Function	uint MDIO_initPHY(Handle hMDIO, uint phyAddr);
Arguments	Handle hMDIO uint phyAddr
Return Value	uint
Description	Force a switch to the specified PHY, and start negotiation. This call is only used to override the normal PHY detection process. Returns 1 if the PHY selection completed OK, else 0
Example	<pre>Handle hMDIO; uint retStat; ... retStat = MDIO_initPHY(hMDIO, 0);</pre>

MDIO_open *Opens the MDIO peripheral and starts searching for a PHY device*

Function	Handle MDIO_open(uint mdioModeFlags);
Arguments	uint mdioModeFlags Mode flags for initializing device
Return Value	void*
Description	Opens the MDIO peripheral and start searching for a PHY device. It is assumed that the MDIO module is reset prior to calling this function.
Example	<pre>Handle hMDIO; ... hMDIO = MDIO_open(MDIO_MODEFLG_HD10);</pre>

MDIO_phyRegRead

MDIO_phyRegRead *Raw data read of a PHY register*

Function	<pre>uint MDIO_phyRegRead(uint phyIdx, uint phyReg, Uint16 *pData);</pre>
Arguments	uint phyIdx PHYADR value uint phyReg REGADR value Uint16 *pData Pointer to store data read
Return Value	uint
Description	Raw data read of a PHY register. Returns 1 if the PHY ACK'd the read, else 0
Example	<pre>uint retStat; Uint16 *pData; ... retStat = MDIO_phyRegRead(0, 0, pData);</pre>

MDIO_phyRegWrite *Raw data write of a PHY register*

Function	<pre>uint MDIO_phyRegWrite(uint phyIdx, uint phyReg, Uint16 data);</pre>
Arguments	uint phyIdx PHYADR value uint phyReg REGADR value Uint16 data Data to be written
Return Value	uint
Description	Raw data write of a PHY register. Returns 1 if the PHY ACK'd the write, else 0
Example	<pre>uint retStat; ... retStat = MDIO_phyRegWrite(0, 0, 0);</pre>

MDIO_SUPPORT *Compile-time constant*

Constant	MDIO_SUPPORT
Description	Compile-time constant that has a value of 1 if the device supports the MDIO module and 0 otherwise. You are not required to use this constant.

MDIO_timerTick *Called to signify that approximately 100 mS have elapsed*

Function	uint MDIO_timerTick(Handle hMDIO);
Arguments	Handle hMDIO
Return Value	uint
Description	Called to signify that approx 100 mS have elapsed Returns an MDIO event code (see MDIO Events in csl_mdio.h)
Example	<pre>Handle hMDIO; uint evtCode; ... evtCode = MDIO_timerTick(hMDIO);</pre>

PCI Module

This chapter describes the PCI module, lists the API functions and macros within the module, discusses the three application domains, and provides a PCI API reference section.

Topic	Page
18.1 Overview	18-2
18.2 Macros	18-4
18.3 Configuration Structure	18-6
18.4 Functions	18-7

18.1 Overview

The PCI module APIs cover the following three application domains:

- APIs that are dedicated to DSP-PCI Master transfers (mainly starting with the prefix `xfr`)
- APIs that are dedicated to EEPROM operations such as write, read, and erase (starting with the prefix `eeeprom`)
- APIs that are dedicated to power management

Table 18–1 lists the configuration structure for use with the PCI functions.

Table 18–2 lists the functions and constants available in the CSL PCI module.

Table 18–1. PCI Configuration Structure

Syntax	Type	Description	See page ...
PCI_ConfigXfr	S	PCI configuration structure	18-6

Table 18–2. PCI APIs

Syntax	Type	Description	See page ...
PCI_curByteCntGet	F	Returns the current number of bytes left (CCNT)	18-7
PCI_curDspAddrGet	F	Returns the current DSP address (CDSPA)	18-7
PCI_curPciAddrGet	F	Returns the current PCI address (CPCIA)	18-7
PCI_dsplntReqClear	F	Clears the DSP-to-PCI interrupt request bit	18-8
PCI_dsplntReqSet	F	Sets the DSP-to-PCI interrupt request bit	18-8
PCI_eeepromErase	F	Erases the specified EEPROM 16-bit address	18-8
PCI_eeepromEraseAll	F	Erases the whole EEPROM	18-9
PCI_eeepromIsAutoCfg	F	Tests if the PCI reads the configure values from EEPROM	18-9
PCI_eeepromRead	F	Reads a 16-bit data from the EEPROM	18-9
PCI_eeepromSize	F	Returns EEPROM size	18-10
PCI_eeepromTest	F	Tests if EEPROM present	18-10
PCI_eeepromWrite	F	Writes a 16-bit data into the EEPROM	18-10

Note: F = Function; C = Constant

† Not supported by 6415/6416 devices

Table 18–2. PCI APIs (Continued)

Syntax	Type	Description	See page ...
PCI_eepromWriteAll	F	Writes a 16-bit data through the whole EEPROM	18-11
PCI_EVT_NNNN	C	PCI events	18-11
PCI_inClear	F	Clears the specified event flag of PCIIS register	18-11
PCI_intDisable	F	Disables the specified PCI event	18-12
PCI_intEnable	F	Enables the specified PCI event	18-12
PCI_intTest	F	Tests an event to see if its flag is set in the PCIIS	18-12
PCI_pwrStatTest [†]	F	Tests if Current State is equal to Requested State	18-13
PCI_pwrStatUpdate [†]	F	Updates the Power-Management State	18-13
PCI_SUPPORT	C	Compile time constant	18-13
PCI_xfrByteCntSet	F	Sets the number of bytes to be transferred	18-14
PCI_xfrConfig	F	Configures the PCI registers related to the data transfer between the DSP and PCI	18-14
PCI_xfrConfigArgs	F	Configures the PCI registers related to the data transfer between the DSP and PCI	18-15
PCI_xfrEnable [†]	F	Enables the internal transfer request to the auxiliary DMA channel	18-15
PCI_xfrFlush	F	Flushes the current transaction	18-16
PCI_xfrGetConfig	F	Returns the current PCI register setting related to the transfer between the DSP and PCI	18-16
PCI_xfrHalt [†]	F	Prevents the PCI from performing an auxiliary. DMA transfer request	18-16
PCI_xfrStart	F	Enables the specified transaction	18-17
PCI_xfrTest	F	Tests if the transaction is complete	18-17

Note: F = Function; C = Constant

[†] Not supported by 6415/6416 devices

18.2 Macros

There are two types of PCI macros: those that access registers and fields, and those that construct register and field values.

Table 18–3 lists the PCI macros that access registers and fields, and Table 18–4 lists the PCI macros that construct register and field values. The macros themselves are found in Chapter 28, *Using the HAL Macros*.

PCI macros are not handle-based.

Table 18–3. PCI Macros that Access Registers and Fields

Macro	Description/Purpose	See page ...
PCI_ADDR(<REG>)	Register address	28-12
PCI_RGET(<REG>)	Returns the value in the peripheral register	28-18
PCI_RSET(<REG>,x)	Register set	28-20
PCI_FGET(<REG>,<FIELD>)	Returns the value of the specified field in the peripheral register	28-13
PCI_FSET(<REG>,<FIELD>,fieldval)	Writes <i>fieldval</i> to the specified field in the peripheral register	28-15
PCI_FSETS(<REG>,<FIELD>,<SYM>)	Writes the symbol value to the specified field in the peripheral	28-17
PCI_RGETA(addr,<REG>)	Gets register for a given address	28-19
PCI_RSETA(addr,<REG>,x)	Sets register for a given address	28-20
PCI_FGETA(addr,<REG>,<FIELD>)	Gets field for a given address	28-13
PCI_FSETA(addr,<REG>,<FIELD>,fieldval)	Sets field for a given address	28-16
PCI_FSETSA(addr,<REG>,<FIELD>,<SYM>)	Sets field symbolically for a given address	28-17

Table 18–4. PCI Macros that Construct Register and Field Values

Macro	Description/Purpose	See page ...
PCI_<REG>_DEFAULT	Register default value	28-21
PCI_<REG>_RMK()	Register make	28-23
PCI_<REG>_OF()	Register value of ...	28-22
PCI_<REG>_<FIELD>_DEFAULT	Field default value	28-24
PCI_FMK()	Field make	28-14
PCI_FMKS()	Field make symbolically	28-15
PCI_<REG>_<FIELD>_OF()	Field value of ...	28-24
PCI_<REG>_<FIELD>_<SYM>	Field symbolic value	28-24

18.3 Configuration Structure

PCI_ConfigXfr *Structure that sets up registers related to master transfer*

Structure	PCI_ConfigXfr
Members	dspma DSP master address register pcima PCI master address register pcimc PCI master control register (For C64x devices only) trctl PCI transfer request control register
Description	This is the PCI configuration structure used to set up the registers related to the master transfer. You can create and initialize this structure then pass its address to the <code>PCI_xfrConfigA()</code> function. You can use literal values.
Example	<pre>PCI_ConfigXfr myXfrConfig = { 0x80000000, /* dspma register Addr to be read*/ 0xFBE80000, /* pcima register XBIAS1 CPLD addr*/ 0x00040000 /* pcimc register 4-byte transfer*/ }; PCI_xfrConfig(&myXfrConfig);</pre>

18.4 Functions

PCI_curByteCntGet *Returns number of bytes left (CCNT)*

Function	Uint32 PCI_curByteCntGet();
Arguments	none
Return Value	number of bytes
Description	Returns number of bytes left on the current master transaction.
Example	<pre>Uint32 nbBytes; nbBytes = PCI_curByteCntGet();</pre>

PCI_curDspAddrGet *Returns current DSP address*

Function	Uint32 PCI_curDspAddrGet();
Arguments	none
Return Value	DSP Address
Description	Returns the current DSP Address of the master transactions.
Example	<pre>Uint32 dspAddr; dspAddr = PCI_curDspAddrGet();</pre>

PCI_curPciAddrGet *Returns current PCI address*

Function	Uint32 PCI_curPciAddrGet();
Arguments	none
Return Value	PCI Address
Description	Returns the current PCI Address of the master transactions.
Example	<pre>Uint32 pciAddr; pciAddr = PCI_curPciAddrGet();</pre>

PCI_dspIntReqClear

PCI_dspIntReqClear *Clears DSP-to-PCI interrupt request bit*

Function	void PCI_dspIntReqClear();
Arguments	none
Return Value	none
Description	Clears the DSP-to-PCI interrupt request bit of the RSTSRC register.
Example	<pre>PCI_dspIntReqClear();</pre>

PCI_dspIntReqSet *Sets DSP-to-PCI interrupt request bit*

Function	void PCI_dspIntReqSet();
Arguments	none
Return Value	none
Description	Sets the DSP-to-PCI interrupt request bit of the RSTSRC register.
Example	<pre>PCI_dspIntReqSet();</pre>

PCI_eeepromErase *Erases specified EEPROM byte*

Function	UInt32 PCI_eeepromErase(UInt32 eeaddr);
Arguments	eeaddr address of the 16-bit data to be erased
Return Value	0 or 1 (success)
Description	Erases the 16-bit data at the specified address. The “Enable Write EWEN” is performed under this function.
Example	<pre>UInt32 success; success = PCI_eeepromErase(0x00000002);</pre>

PCI_eepromEraseAll *Erases entire EEPROM*

Function **Uint32** PCI_eepromEraseAll()

Arguments **none** address of the 16-bit data to be erased

Return Value 0 or 1 (success)

Description Erases the full EEPROM.

Example

```

Uint32 success;
success = PCI_eepromEraseAll();

```

PCI_eepromIsAutoCfg *Tests if PCI reads configure-values from EEPROM*

Function **Uint32** PCI_eepromIsAutoCfg();

Arguments **none**

Return Value 0 or 1

Description Tests if the PCI reads configure-values from EEPROM. Returns value of the EEAI field of EECTL register.

Example

```

Uint32 x;
x = PCI_eepromIsAutoCfg();

```

PCI_eepromRead *Reads 16-bit data from EEPROM*

Function **Uint16** PCI_eepromRead(
Uint32 eeaddr
);

Arguments **eeaddr** Address of the 16-bit data to be read from EEPROM.

Return Value value of the 16-bit data

Description Reads the 16-bit data at the specified address from EEPROM.

Example

```

Uint16 eepromdata;
eepromdata = PCI_eepromRead(0x00000001);

```

PCI_eeepromSize

PCI_eeepromSize *Returns EEPROM size*

Function	UInt32 PCI_eeepromSize();
Arguments	none
Return Value	value of the size code
Description	Returns the code associated with the size of the EEPROM. <input type="checkbox"/> 0x0 :000 No EEPROM present <input type="checkbox"/> 0x1 :001 1K_EEPROM <input type="checkbox"/> 0x2 :010 2K_EEPROM <input type="checkbox"/> 0x3 :011 4K_EEPROM (6415/6416 devices support the 4K_EEPROM only) <input type="checkbox"/> 0x4 :100 16K_EEPROM
Example	<pre>UInt32 eeepromSZ; eeepromSZ = PCI_eeepromSize();</pre>

PCI_eeepromTest *Tests if EEPROM is present*

Function	UInt32 PCI_eeepromTest();
Arguments	none
Return Value	0 or 1
Description	Tests if EEPROM is present by reading the code size bits EESZ[2:0]
Example	<pre>UInt32 eeepromIs; eeepromIs = PCI_eeepromTest();</pre>

PCI_eeepromWrite *Writes 8-bit data into EEPROM*

Function	UInt32 PCI_eeepromWrite(UInt32 eeaddr, UInt16 eeedata);
Arguments	eeaddr Address of the byte to read from EEPROM. eeedata 16-bit data to be written.
Return Value	0 or 1

Description Writes the 16-bit data into the specified EEPROM address. The “Enable Write EWEN” is performed under this function.

Example

```

    Uint16 x;
    x = PCI_eepromWrite(0x123,0x8888);
  
```

PCI_eepromWriteAll *Writes 16-bit data into entire EEPROM*

Function Uint32 PCI_eepromWriteAll(
 Uint16 eedata
);

Arguments eedata 16-bit data to be written.

Return Value 0 or 1

Description Writes the 16-bit data into the entire EEPROM.

Example

```

    Uint16 x;
    x = PCI_eepromWriteAll(0x1234);
  
```

PCI_EVT_NNN *PCI events (PCIEN register)*

Constant

```

    PCI_EVT_DMAHALTED
    PCI_EVT_PRST
    PCI_EVT_EERDY
    PCI_EVT_CFGERR
    PCI_EVT_CFGDONE
    PCI_EVT_MASTEROK
    PCI_EVT_PWRHL
    PCI_EVT_PWRLH
    PCI_EVT_HOSTSW
    PCI_EVT_PCIMASTER
    PCI_EVT_PCITARGET
    PCI_EVT_PWRMGMT
  
```

Description These are the PCI events. For more details regarding these events, refer to the *TMS320C6000 Peripherals Reference Guide (SPRU190)*.

PCI_intClear *Clears the specified event flag*

Function void PCI_intClear(
 Uint32 eventPci
);

Arguments eventPci See PCI_EVT_NNNN for a complete list of PCI events.

PCI_intDisable

Return Value	none
Description	Clears the specified event flag of PCIIS register by writing '1' to the associated bit.
Example	<pre>PCI_intClear(PCI_EVT_MASTEROK);</pre>

PCI_intDisable *Disable specified PCI event*

Function	<pre>void PCI_intDisable(Uint32 eventPci);</pre>
Arguments	eventPci See PCI_EVT_NNNN for a complete list of PCI events.
Return Value	none
Description	Disables the specified PCI event.
Example	<pre>PCI_intDisable(PCI_EVT_MASTEROK);</pre>

PCI_intEnable *Enables specified PCI event*

Function	<pre>void PCI_intEnable(Uint32 eventPci);</pre>
Arguments	eventPci See PCI_EVT_NNNN for a complete list of PCI events.
Return Value	none
Description	Enables the specified PCI event.
Example	<pre>PCI_intEnable(PCI_EVT_MASTEROK);</pre>

PCI_intTest *Test if specified PCI event flag is set*

Function	<pre>Uint32 PCI_intTest(Uint32 eventPci);</pre>
Arguments	eventPci See PCI_EVT_NNNN for a complete list of PCI events.

Return Value 0 or 1

Description Tests if the specified event flag was set in the PCIIS register.

Example

```

    Uint32 x;
    x = PCI_intTest (PCI_EVT_MASTEROK);
    
```

PCI_pwrStatTest *Tests if DSP has changed state*

Function Uint32 PCI_pwrStatTest();

Arguments none

Return Value Returns the following value if state change has occurred:

- 0: No State change request
- 1: Requested State D0/D1
- 2: Requested State D2
- 3: Requested State D3

Description Tests if the DSP has received an event related to a state change (not supported by 64x devices).

Example

```

    PCI_pwrStatTest ();
    
```

PCI_pwrStatUpdate *Updates current state of power management*

Function void PCI_pwrStatUpdate();

Arguments none

Return Value none

Description Updates the current state field of the PWDSRC register with the request state field value (not supported by 64x devices).

Example

```

    PCI_pwrStatUpdate ();
    
```

PCI_SUPPORT *Compile-time constant*

Constant PCI_SUPPORT

Description Compile-time constant that has a value of 1 if the device supports the PCI module and 0 otherwise. You are not required to use this constant.

PCI_xfrByteCntSet

Currently, all devices support this module.

Example

```
#if (PCI_SUPPORT)
    /* user PCI configuration */
#endif
```

PCI_xfrByteCntSet *Sets number of bytes to be transferred*

Function void PCI_xfrByteCntSet(
 Uint16 nbbyte
);

Arguments nbbyte Number of bytes to be transferred for the next transaction.
 1 < nbbyte < 65K max

Return Value 0 or 1

Description Sets the number of bytes to transfer.

Example PCI_xfrByteCntSet(0xFFFF); /* maximum of bytes */

PCI_xfrConfig *Sets up registers related to master transfer using config structure*

Function void PCI_xfrConfig(
 PCI_ConfigXfr *config
);

Arguments config Pointer to an initialized configuration structure.

Return Value none

Description Sets up the PCI registers related to the master transfer using the configuration structure. The values of the structure are written to the PCI registers. See also PCI_xfrConfigArgs() and PCI_ConfigXfr.

Example

```
PCI_ConfigXfr myXfrConfig = {
0x80000000, /* dspma reg location data (src or dst)*/
0xFBE8000, /* pcima reg CPLD XBISA */
0x0004000 /* pcimc register */
};
PCI_xfrConfig(&myXfrConfig);
```

PCI_xfrConfigArgs *Sets up registers related to master transfer using register values*

Function	void PCI_xfrConfigArgs(Uint32 dspma, Uint32 pcima, Uint32 pcimc Uint32 trctl (For C64x devices only));
Arguments	dspma DSP master address register value pcima PCI master address register value pcimc PCI master control register value For C64x devices only) trctl PCI transfer request control register
Return Value	none
Description	Sets up the PCI registers related to the master transfer using the register values passed in. The register values are written to the PCI registers. See also PCI_xfrConfig().
Example	<pre> PCI_xfrConfigArgs{ 0x80001000, /* dspma register */ 0xFBE00000, /* pcima register CPLD XBISA DSP reg*/ 0x0100000 /* pcimc register 256-byte transfer*/ }; </pre>

PCI_xfrEnable *Enables internal transfer request to auxiliary DMA channel*

Function	void PCI_xfrEnable();
Arguments	none
Return Value	none
Description	Enables the internal transfer request to the auxilliary DMA channel by clearing the HALT bit field of the HALT register (C620x/C670x only, not supported by 64x devices).
Example	<pre> PCI_xfrEnable(); </pre>

PCI_xfrFlush

PCI_xfrFlush *Flushes current transaction*

Function	void PCI_xfrFlush();
Arguments	none
Return Value	none
Description	Flushes the current transaction. The transfer will stop and the FIFOs will be flushed.
Example	<pre>PCI_xfrFlush();</pre>

PCI_xfrGetConfig *Reads configuration by returning values through config structure*

Function	void PCI_xfrGetConfig(PCI_ConfigXfr *config);
Arguments	config Pointer to the returned configuration structure.
Return Value	none
Description	Reads the current PCI configuration by returning values through the configuration structure. The values of the PCI register are written to the configuration structure. See also PCI_ConfigXfr.
Example	<pre>PCI_ConfigXfr myXfrConfig; PCI_xfrGetConfig(&myXfrConfig);</pre>

PCI_xfrHalt *Terminates internal transfer requests to auxilliary DMA channel*

Function	void PCI_xfrHalt();
Arguments	none
Return Value	none
Description	Halts the internal transfer requests to the auxilliary DMA channel by setting the HALT bit field of the HALT register (C620x/C670x only, not supported by 64x devices).
Example	<pre>PCI_xfrHalt();</pre>

PCI_xfrStart *Starts transaction*

Function	void PCI_xfrStart(Uint32 modeXfr);
Arguments	modeXfr Specified one of the following transfer modes (macros): <input type="checkbox"/> PCI_WRITE or 0x1 <input type="checkbox"/> PCI_READ_PREF or 0x2 <input type="checkbox"/> PCI_READ_NOPREF or 0x3
Return Value	none
Description	Starts the specified transaction.
Example	PCI_xfrStart (PCI_WRITE) ;

PCI_xfrTest *Tests if current transaction is complete*

Function	Uint32 PCI_xfrTest();
Arguments	none
Return Value	0 to 7
Description	Tests the status of the master transaction and returns one of the following status values: <input type="checkbox"/> PCI_PCIMC_START_FLUSH: Transaction not started/flush current transaction <input type="checkbox"/> PCI_PCIMC_START_WRITE: Start a master write transaction <input type="checkbox"/> PCI_PCIMC_START_READPREF: Start a master read transaction to prefetchable memory <input type="checkbox"/> PCI_PCIMC_START_READNOPREF: Start a master read transaction to nonprefetchable memory <input type="checkbox"/> PCI_PCIMC_START_CONFIGWRITE: Start a configuration write <input type="checkbox"/> PCI_PCIMC_START_CONFIGREAD: Start a configuration read <input type="checkbox"/> PCI_PCIMC_START_IOWRITE: Start an I/O write <input type="checkbox"/> PCI_PCIMC_START_IOREAD: Start an I/O read
Example	PCI_xfrTest ();

PLL Module

This chapter describes the PLL module, lists the API functions and macros within the module, discusses the three application domains, and provides a PLL API reference section.

Topic	Page
19.1 Overview	19-2
19.2 Macros	19-4
19.3 Configuration Structures	19-6
19.4 Functions	19-7

19.1 Overview

This module provides functions and macros to configure the PLL controller. The PLL controller peripheral is in charge of controlling the DSP clock.

Table 19–1 lists the configuration structure for use with the PLL functions.

Table 19–2 lists the functions and constants available in the CSL PLL module.

Table 19–1. PLL Configuration Structures

Syntax	Type	Description	See page ...
PLL_Config	S	Structure used to configure the PLL controller	19-6
PLL_Init	S	Structure used to initialize the PLL controller	19-6

Table 19–2. PLL APIs

Syntax	Type	Description	See page ...
PLL_bypass	F	Sets the PLL in bypass mode	19-7
PLL_clkTest	F	Checks and returns the oscillator input stable condition	19-7
PLL_config	F	Configures the PLL using the configuration structure	19-8
PLL_configArgs	F	Configures the PLL using register fields as arguments	19-8
PLL_deassert	F	Releases the PLL from reset	19-9
PLL_disableOscDiv	F	Disables the oscillator divider OD1	19-9
PLL_disablePIIDiv	F	Disables the specified divider	19-9
PLL_enable	F	Enables the PLL	19-10
PLL_enableOscDiv	F	Enables the oscillator divider OD1	19-10
PLL_enablePIIDiv	F	Enables the specified divider	19-11
PLL_getConfig	F	Reads the current PLL controller configuration values	19-11
PLL_getMultiplier	F	Returns the PLL multiplier value	19-11
PLL_getOscRatio	F	Returns the oscillator divide ratio	19-12
PLL_getPIIRatio	F	Returns the PLL divide ratio	19-12
PLL_init	F	Initializes the PLL using the <code>PLL_Init</code> structure	19-12
PLL_operational	F	Sets the PLL in operational mode	19-13

Note: F = Function; C = Constant

Table 19–2. PLL APIs (Continued)

Syntax	Type	Description	See page ...
PLL_pwrdown	F	Sets the PLL in power down state	19-13
PLL_reset	F	Resets the PLL	19-14
PLL_setMultiplier	F	Sets the PLL multiplier value	19-14
PLL_setOscRatio	F	Sets the oscillator divide ratio (CLKOUT3 divider)	19-14
PLL_setPIIRatio	F	Sets the PLL divide ratio	19-15
PLL_SUPPORT	C	A compile time constant whose value is 1 if the device supports PLL	19-16

Note: F = Function; C = Constant

19.1.1 Using the PLL Controller

The PLL controller can be used by passing an initialized `PLL_Config` structure to `PLL_config()` or by passing register values to the `PLL_configArgs()` function. To assist in creating register values, the `_RMK(make)` macros construct register values based on field values. In addition, the symbol constants may be used for the field values.

The PLL can also be initialized based on parameters by passing a `PLL_Init` structure to the `PLL_init()` function.

19.2 Macros

There are two types of PLL macros: those that access registers and fields, and those that construct register and field values.

Table 19–3 lists the PLL macros that access registers and fields, and Table 19–4 lists the PLL macros that construct register and field values. The macros themselves are found in Chapter 28, *Using the HAL Macros*.

PLL macros are not handle-based.

Table 19–3. PLL Macros that Access Registers and Fields

Macro	Description/Purpose	See page ...
PLL_ADDR(<REG>)	Register address	28-12
PLL_RGET(<REG>)	Returns the value in the peripheral register	28-18
PLL_RSET(<REG>,x)	Register set	28-20
PLL_FGET(<REG>,<FIELD>)	Returns the value of the specified field in the peripheral register	28-13
PLL_FSET(<REG>,<FIELD>,fieldval)	Writes <i>fieldval</i> to the specified field in the peripheral register	28-15
PLL_FSETS(<REG>,<FIELD>,<SYM>)	Writes the symbol value to the specified field in the peripheral	28-17
PLL_RGETA(addr,<REG>)	Gets register for a given address	28-19
PLL_RSETA(addr,<REG>,x)	Sets register for a given address	28-20
PLL_FGETA(addr,<REG>,<FIELD>)	Gets field for a given address	28-13
PLL_FSETA(addr,<REG>,<FIELD>,fieldval)	Sets field for a given address	28-16
PLL_FSETSA(addr,<REG>,<FIELD>,<SYM>)	Sets field symbolically for a given address	28-17

Table 19–4. PLL Macros that Construct Register and Field Values

Macro	Description/Purpose	See page ...
PLL_<REG>_DEFAULT	Register default value	28-21
PLL_<REG>_RMK()	Register make	28-23
PLL_<REG>_OF()	Register value of ...	28-22
PLL_<REG>_<FIELD>_DEFAULT	Field default value	28-24
PLL_FMK()	Field make	28-14
PLL_FMKS()	Field make symbolically	28-15
PLL_<REG>_<FIELD>_OF()	Field value of ...	28-24
PLL_<REG>_<FIELD>_<SYM>	Field symbolic value	28-24

PLL_Config

19.3 Configuration Structures

PLL_Config

Structure used to configure the PLL controller

Structure

PLL_Config

Members

UInt32 pllcsr PLL control/status register
UInt32 pllmm PLL multiplier control register
UInt32 plldiv0 PLL controller divider 0 register
UInt32 plldiv1 PLL controller divider 1 register
UInt32 plldiv2 PLL controller divider 2 register
UInt32 plldiv3 PLL controller divider 3 register
UInt32 oscdiv1 Oscillator divider 1 register

Description

This is the PLL configuration structure used to configure the PLL controller. The user should create and initialize this structure before passing its address to the `PLL_config()` function.

PLL_Init

Structure used to initialize the PLL controller

Structure

PLL_Init

Members

UInt32 mdiv PLL multiplier
UInt32 d0ratio PLL divider 0 ratio
UInt32 d1ratio PLL divider 1 ratio
UInt32 d2ratio PLL divider 2 ratio
UInt32 d3ratio PLL divider 3 ratio
UInt32 od1ratio Oscillator divider 1 ratio

Description

This is the PLL initialization structure used to initialize the PLL controller. The user should create and initialize this structure before passing its address to the `PLL_init()` function.

19.4 Functions

PLL_bypass *Sets the PLL in bypass mode*

Function	<code>void PLL_bypass(void);</code>
Arguments	none
Return Value	none
Description	This function sets the PLL in bypass mode wherein Divider D0 and PLL are bypassed. SYSCLK1 to SYSCLK3 are divided down directly from the input reference clock.
Example	<code>PLL_bypass();</code>

PLL_clkTest *Checks and returns the oscillator input stable condition*

Function	<code>void Uint32 PLL_clkTest(void);</code>
Arguments	none
Return Value	Uint32 Oscillator condition <input type="checkbox"/> 0 – Not stable <input type="checkbox"/> 1 – Stable
Description	<p>This function checks and returns the oscillator input stable condition.</p> <p>0 – OSCIN/CLKIN input not yet stable. This is true if the synchronous counter has not finished counting.</p> <p>1 – OSCIN/CLKIN input is stable. This is true if any one of the following three cases is true:</p> <ul style="list-style-type: none">■ Synchronous counter has finished counting the number of OSCIN/CLKIN cycles■ Synchronous counter is disabled■ Test mode
Example	<code>Uint32 val; val = PLL_clkTest();</code>

PLL_config

PLL_config

Configures the PLL using the configuration structure

Function	<pre>void PLL_config(PLL_Config *myConfig);</pre>
Arguments	myConfig Pointer to the configuration structure
Return Value	none
Description	This function configures the PLL controller using the configuration structure. The values of the structure variables are written to the PLL controller registers.
Example	<pre>PLL_Config MyConfig ... PLL_config(&MyConfig);</pre>

PLL_configArgs

Configures the PLL controller using register fields as arguments

Function	<pre>void PLL_configArgs(Uint32 pllcsr, Uint32 pllmm, Uint32 plldiv0, Uint32 plldiv1, Uint32 plldiv2, Uint32 plldiv3, Uint32 oscdiv1)</pre>
Arguments	pllcsr PLL control/status register pllmm PLL multiplier control register plldiv0 PLL controller divider 0 register plldiv1 PLL controller divider 1 register plldiv2 PLL controller divider 2 register plldiv3 PLL controller divider 3 register oscdiv1 Oscillator divider 1 register
Return Value	none
Description	This function configures the PLL controller as per the register field values given.
Example	<pre>PLL_configArgs(0x8000, 0x01, 0x800A, 0x800B, 0x800C, 0x800D, 0x0009);</pre>

PLL_deassert *Releases the PLL from reset*

Function	<code>void PLL_deassert(void);</code>
Arguments	none
Return Value	none
Description	This function releases the PLL from reset.
Example	<code>PLL_deassert();</code>

PLL_disableOscDiv *Disables the oscillator divider OD1*

Function	<code>void PLL_disableOscDiv(void);</code>
Arguments	none
Return Value	none
Description	This function disables the oscillator divider OD1.
Example	<code>PLL_disableOscDiv();</code>

PLL_disablePIIDiv *Disables the specified divider*

Function	<code>void PLL_disablePIIDiv(Uint32 divId);</code>
Arguments	<code>divId</code> Divider ID <input type="checkbox"/> PLL_DIV0 – Divider 0 <input type="checkbox"/> PLL_DIV1 – Divider 1 <input type="checkbox"/> PLL_DIV2 – Divider 2 <input type="checkbox"/> PLL_DIV3 – Divider 3
Return Value	none

PLL_enable

Description This function disables the divider specified by the 'divld' parameter.

Example `PLL_disablePllDiv(PLL_DIV0);`

PLL_enable *Enables the PLL*

Function `void PLL_enable(
void
);`

Arguments none

Return Value none

Description This function enables the PLL and sets it in 'PLL' mode. Note that here divider D0 is not bypassed. SYSCLK1 to SYSCLK3 are divided down directly from the input reference clock.

Example `PLL_enable();`

PLL_enableOscDiv *Enables the oscillator divider OD1*

Function `void PLL_enableOscDiv(
void
);`

Arguments none

Return Value none

Description This function enables the oscillator divider OD1.

Example `PLL_enableOscDiv();`

PLL_enablePIIDiv *Enables the specified divider*

Function	<pre>void PLL_enablePIIDiv(Uint32 divId);</pre>
Arguments	<p>divId Divider ID</p> <ul style="list-style-type: none"><input type="checkbox"/> PLL_DIV0 – Divider 0<input type="checkbox"/> PLL_DIV1 – Divider 1<input type="checkbox"/> PLL_DIV2 – Divider 2<input type="checkbox"/> PLL_DIV3 – Divider 3
Return Value	none
Description	This function enables the divider specified by the 'divId' parameter.
Example	<pre>PLL_enablePllDiv(PLL_DIV0);</pre>

PLL_getConfig *Reads the current PLL controller configuration values*

Function	<pre>void PLL_getConfig(PLL_Config *myConfig);</pre>
Arguments	myConfig Pointer to the configuration structure
Return Value	none
Description	This function gets the current PLL configuration values.
Example	<pre>PLL_Config pllCfg; ... PLL_getConfig(&pllCfg);</pre>

PLL_getMultiplier *Returns the PLL multiplier value*

Function	<pre>Uint32 PLL_getMultiplier(void);</pre>
Arguments	none

PLL_getOscRatio

Return Value	UInt32 PLL multiplier value. See PLL_setMultiplier().
Description	This function gets the current PLL multiplier value. For PLL multiplier values, see PLL_setMultiplier().
Example	<pre>UInt32 val; val = PLL_getMultiplier();</pre>

PLL_getOscRatio *Returns the oscillator divide ratio*

Function	<pre>UInt32 PLL_getOscRatio(void);</pre>
Arguments	none
Return Value	UInt32 Oscillator divide ratio. See PLL_setOscRatio().
Description	This function returns the oscillator divide ratio. For oscillator divide values, see PLL_setOscRatio().
Example	<pre>UInt32 val; val = PLL_getOscRatio();</pre>

PLL_getPIIRatio *Returns the PLL divide ratio*

Function	<pre>UInt32 PLL_getPllcRatio(void);</pre>
Arguments	divId PLL divider ID. See PLL_setPllRatio().
Return Value	UInt32 PLL divide ratio. See PLL_setPllRatio().
Description	This function returns the PLL divide ratio. For PLL divide values, see PLL_setPllRatio().
Example	<pre>UInt32 val; val = PLL_getPllRatio(PLL_DIV0);</pre>

PLL_init *Initialize PLL using PLL_Init structure*

Function	<pre>void PLL_init(PLL_Init *myInit);</pre>
Arguments	myInit Pointer to the initialization structure.

Return Value	none
Description	This function initializes the PLL controller using the PLL_Init structure. The values of the structure variables are written to the corresponding PLL controller register fields.
Example	<pre>PLL_Init myInit; ... PLL_init(&myInit);</pre>

PLL_operational *Sets PLL in operational mode*

Function	<pre>void PLL_operational(void);</pre>
Arguments	none
Return Value	none
Description	This function sets the PLL in operational mode. See PLL_pwrdown(). This function enables the PLL and Divider 0 path.
Example	<pre>PLL_operational();</pre>

PLL_pwrdown *Sets the PLL in power down mode*

Function	<pre>void PLL_pwrdown(void);</pre>
Arguments	none
Return Value	none
Description	This function sets the PLL in power down state. Divider D0 and the PLL are bypassed. SYSCLK1 to SYSCLK3 are divided down directly from the input reference clock.
Example	<pre>PLL_pwrdown();</pre>

PLL_reset

PLL_reset *Resets the PLL device*

Function	<code>void PLL_reset(void);</code>
Arguments	none
Return Value	none
Description	This function asserts reset to the PLL.
Example	<code>PLL_reset();</code>

PLL_setMultiplier *Sets the PLL multiplier value*

Function	<code>void PLL_setMultiplier(Uint32 val);</code>
Arguments	val Multiplier select
Return Value	none
Description	This function sets the PLL multiplier value. PLL multiplier select 00000 = x1 00001=x2 00010=x3 00011=x4, 00000 = x5 00001=x6 00010=x7 00011=x8, 00000 = x9 00001=x10 00010=x11 00011=x12, 00000 = x13 00001=x14 00010=x15 00011=x16 00000 = x17 00001=x18 00010=x19 00011=x20, 00000 = x21 00001=x22 00010=x23 00011=x24, 00000 = x25 00001=x26 00010=x28 00011=x28, 00000 = x29 00001=x30 00010=x31 00011=Not Supported
Example	<code>PLL_setMultiplier(0x04);</code>

PLL_setOscRatio *Sets the oscillator divide ratio (CLKOUT3 divider)*

Function	<code>void PLL_setOscRatio(Uint32 val);</code>
Arguments	val Divider values

Return Value none

Description This function sets the oscillator divide ratio (CLKOUT3 divider).

Divider values

00000 = /1	00001=/2	00010=/3	00011=/4,
00000 = /5	00001=/6	00010=/7	00011=/8,
00000 = /9	00001=/10	00010=/11	00011=/12,
00000 = /13	00001=/14	00010=/15	00011=/16
00000 = /17	00001=/18	00010=/19	00011=/20,
00000 = /21	00001=/22	00010=/23	00011=/24,
00000 = /25	00001=/26	00010=/28	00011=/28,
00000 = /29	00001=/30	00010=/31	00011=/32

Example `PLL_setOscRatio(0x05);`

PLL_setPIIRatio *Sets the PLL divide ratio*

Function `void PLL_setPIIDiv(
 uint32_t divId,
 uint32_t val
);`

Arguments `divId` Divider ID

- PLL_DIV0 – Divider 0
- PLL_DIV1 – Divider 1
- PLL_DIV2 – Divider 2
- PLL_DIV3 – Divider 3

`val` Divider values

Return Value none

Description This function sets the divide ratio for the clock divider specified by the 'divId' parameter.

PLL_SUPPORT

Description This function sets the divide ratio for the clock divider specified by the 'divld' parameter.

Divider values

00000 = /1	00001 = /2	00010 = /3	00011 = /4,
00000 = /5	00001 = /6	00010 = /7	00011 = /8,
00000 = /9	00001 = /10	00010 = /11	00011 = /12,
00000 = /13	00001 = /14	00010 = /15	00011 = /16
00000 = /17	00001 = /18	00010 = /19	00011 = /20,
00000 = /21	00001 = /22	00010 = /23	00011 = /24,
00000 = /25	00001 = /26	00010 = /28	00011 = /28,
00000 = /29	00001 = /30	00010 = /31	00011 = /32

Example `PLL_setPllDiv(PLL_DIV0, 0x05);`

PLL_SUPPORT *Compile time constant*

Constant PLL_SUPPORT

Description Compile-time constant that has a value of 1 if the device supports the PLL module and 0 otherwise. You are not required to use this constant.

Currently, only the C6713 device supports this module.

Example

```
#if (PLL_SUPPORT)
    /* user PLL configuration */
#endif
```

PWR Module

This chapter describes the PWR module, lists the API functions and macros within the module, and provides a PWR API reference section.

Topic	Page
20.1 Overview	20-2
20.2 Macros	20-3
20.3 Configuration Structure	20-5
20.4 Functions	20-6

20.1 Overview

The PWR module is used to configure the power-down control registers, if applicable, and to invoke various power-down modes.

Table 20–1 lists the configuration structure for use with the PWR functions. Table 20–2 lists the functions and constants available in the CSL PWR module.

Table 20–1. PWR Configuration Structure

Syntax	Purpose	See page ...
PWR_Config	Structure used to set up the PWR options	20-5

Table 20–2. PWR APIs

Syntax	Type	Description	See page ...
PWR_config	F	Sets up the PWR register using the configuration structure	20-6
PWR_configArgs	F	Sets up the power-down logic using the register value passed in	20-6
PWR_getConfig	F	Reads the current PWR configuration values	20-7
PWR_powerDown	F	Forces the DSP to enter a power-down state	20-7
PWR_SUPPORT	C	A compile time constant whose value is 1 if the device supports the PWR module	20-8

Note: F = Function; C = Constant

20.2 Macros

There are two types of PWR macros: those that access registers and fields, and those that construct register and field values.

Table 20–3 lists the PWR macros that access registers and fields, and Table 20–4 lists the PWR macros that construct register and field values. The macros themselves are found in Chapter 28, *Using the HAL Macros*.

PWR macros are not handle-based.

Table 20–3. PWR Macros that Access Registers and Fields

Macro	Description/Purpose	See page ...
PWR_ADDR(<REG>)	Register address	28-12
PWR_RGET(<REG>)	Returns the value in the peripheral register	28-18
PWR_RSET(<REG>,x)	Register set	28-20
PWR_FGET(<REG>,<FIELD>)	Returns the value of the specified field in the peripheral register	28-13
PWR_FSET(<REG>,<FIELD>,fieldval)	Writes <i>fieldval</i> to the specified field in the peripheral register	28-15
PWR_FSETS(<REG>,<FIELD>,<SYM>)	Writes the symbol value to the specified field in the peripheral	28-17
PWR_RGETA(addr,<REG>)	Gets register for a given address	28-19
PWR_RSETA(addr,<REG>,x)	Sets register for a given address	28-20
PWR_FGETA(addr,<REG>,<FIELD>)	Gets field for a given address	28-13
PWR_FSETA(addr,<REG>,<FIELD>,fieldval)	Sets field for a given address	28-16
PWR_FSETSA(addr,<REG>,<FIELD>,<SYM>)	Sets field symbolically for a given address	28-17

Table 20–4. PWR Macros that Construct Register and Field Values

Macro	Description/Purpose	See page ...
PWR_<REG>_DEFAULT	Register default value	28-21
PWR_<REG>_RMK()	Register make	28-23
PWR_<REG>_OF()	Register value of ...	28-22
PWR_<REG>_<FIELD>_DEFAULT	Field default value	28-24
PWR_FMK()	Field make	28-14
PWR_FMKS()	Field make symbolically	28-15
PWR_<REG>_<FIELD>_OF()	Field value of ...	28-24
PWR_<REG>_<FIELD>_<SYM>	Field symbolic value	28-24

20.3 Configuration Structure

PWR_Config *Structure used to set up the PWR options*

Structure	PWR_Config
Members	Uint32 pdctl Power-down control register (6202 and 6203 devices)
Description	This is the PWR configuration structure used to set up the PWR option of the 6202 device. You create and initialize this structure and then pass its address to the <code>PWR_config()</code> function. You can use literal values or the <code>_RMK</code> macros to create the structure member values.
Example	<pre>PWR_Config pwrCfg = { 0x00000000 }; ... PWR_config(&pwrCfg);</pre>

PWR_config

20.4 Functions

PWR_config *Sets up the PWR register using the configuration structure*

Function	<pre>void PWR_config(PWR_Config *config);</pre>
Arguments	config Pointer to a configuration structure.
Return Value	none
Description	Sets up the PWR register using the configuration structure.
Example	<pre>PWR_Config pwrCfg = { 0x00000000 }; PWR_config(&pwrCfg);</pre>

PWR_configArgs *Sets up power-down logic using register value passed in*

Function	<pre>void PWR_configArgs(Uint32 pdctl);</pre>
Arguments	pdctl Power-down control register value
Return Value	none
Description	Sets up the power-down logic using the register value passed in. You may use literal values for the argument or for readability. You may use the <i>PWR_PDCTL_RMK</i> macro to create the register value based on field values.
Example	<pre>PWR_configArgs(0x00000000);</pre>

PWR_getConfig *Reads the current PWR configuration values*

Function	<pre>void PWR_config(PWR_Config *config);</pre>
Arguments	config Pointer to a configuration structure.
Return Value	none
Description	Gets PWR current configuration value.
Example	<pre>PWR_Config pwrCfg; PWR_getConfig(&pwrCfg);</pre>

PWR_powerDown *Forces DSP to enter power-down state*

Function	<pre>void PWR_powerDown(PWR_MODE mode);</pre>
Arguments	mode Power-down mode: <input type="checkbox"/> PWR_NONE <input type="checkbox"/> PWR_PD1A <input type="checkbox"/> PWR_PD1B <input type="checkbox"/> PWR_PD2 <input type="checkbox"/> PWR_PD3 <input type="checkbox"/> PWR_IDLE
Return Value	none
Description	Calling this function forces the DSP to enter a power-down state. Refer to the <i>TMS320C6000 Peripherals Reference Guide</i> (SPRU190) for a description of the power-down modes.
Example	<pre>PWR_powerDown(PWR_PD2);</pre>

PWR_SUPPORT

PWR_SUPPORT *Compile-time constant*

Constant	PWR_SUPPORT
Description	<p>Compile-time constant that has a value of 1 if the device supports the PWR module and 0 otherwise. You are not required to use this constant.</p> <p>Currently, all devices support this module.</p>
Example	<pre>#if (PWR_SUPPORT) /* user PWR configuration / #endif</pre>

TCP Module

This chapter describes the TCP module, lists the API functions and macros within the module, discusses how to use the TCP, and provides a TCP API reference section.

Topic	Page
21.1 Overview	21-2
21.2 Macros	21-6
21.3 Configuration Structures	21-8
21.4 Functions	21-13

21.1 Overview

Currently, there is one TMS320C6000™ device with a turbo coprocessor (TCP): the TMS320C6416. The TCP is intended to be serviced using the EDMA for most accesses, but the CPU must first configure the TCP control values. There are also a number of functions available to the CPU to monitor the TCP status and access decision and output parameter data.

Table 21–1 lists the configuration structures for use with the TCP functions. Table 21–2 lists the functions and constants available in the CSL TCP module.

Table 21–1. TCP Configuration Structures

Syntax	Type	Description	See page ...
TCP_BaseParams	S	Structure used to set basic TCP parameters	21-8
TCP_Configlc	S	Structure containing the IC register values	21-9
TCP_Params	S	Structure containing all channel characteristics	21-10

Table 21–2. TCP APIs

Syntax	Type	Description	See page ...
TCP_calcSubBlocksSA	F	Calculates the sub-blocks within a frame for standalone mode	21-13
TCP_calcSubBlocksSP	F	Calculates the sub-frames and -blocks within a frame for shared processing mode	21-13
TCP_calcCountsSA	F	Calculates the number of elements for each data buffer to be transmitted to/from the TCP using the EDMA for standalone mode	21-13
TCP_calcCountsSP	F	Calculates the number of elements for each data buffer to be transmitted to/from the TCP using the EDMA for shared processing mode	21-13
TCP_calculateHd	F	Calculates hard decisions for shared processing mode	21-14
TCP_ceil	F	Ceiling function	21-14
TCP_deinterleaveExt	F	De-interleaves extrinsics data for shared processing mode	21-15
TCP_demuxInput	F	Demultiplexes input into two working data sets for shared processing mode	21-15
TCP_END_NATIVE	C	Value indicating native endian format	21-16

Note: F = Function; C = Constant

Table 21–2. TCP APIs (Continued)

Syntax	Type	Description	See page ...
TCP_END_PACKED32	C	Value indicating little endian format within packed 32-bit words	21-16
TCP_errTest	F	Returns the error bit of ERR register	21-16
TCP_FLEN_MAX	F	Maximum frame length	21-17
TCP_genIc	F	Generates the <code>TCP_ConfigIc</code> struct based on the TCP parameters provided by the <code>TCP_Params</code> struct	21-17
TCP_genParams	F	Function used to set basic TCP parameters	21-17
TCP_getAccessErr	F	Returns access error flag	21-18
TCP_getAprioriEndian	F	Returns Apriori data endian configuration	21-18
TCP_getExtEndian	F	Returns the Extrinsic data endian configuration	21-19
TCP_getFrameLenErr	C	Returns the frame length error status	21-19
TCP_getIcConfig	F	Returns the IC values already programmed into the TCP	21-19
TCP_getInterEndian	F	Returns the Interleaver Table data endian configuration	21-20
TCP_getInterleaveErr	F	Returns the interleaver table error status	21-20
TCP_getLastRelLenErr	F	Returns the error status for a bad reliability length	21-21
TCP_getModeErr	F	Returns the error status for a bad TCP mode	21-21
TCP_getNumIt	F	Returns the number of iterations performed by the TCP	21-22
TCP_getOutParmErr	F	Returns the output parameters error status	21-22
TCP_getProlLenErr	F	Returns the error status for an invalid prolog length	21-22
TCP_getRateErr	F	Returns the error status for an invalid rate	21-23
TCP_getRelLenErr	F	Returns the error status for an invalid reliability length	21-23
TCP_getSubFrameErr	F	Returns the error status indicating an invalid number of sub frames	21-23
TCP_getSysParEndian	F	Returns the Systematics and Parities data endian configuration	21-24
TCP_icConfig	F	Stores the IC values into the TCP	21-24
TCP_icConfigArgs	F	Stores the IC values into the TCP using arguments	21-25

Note: F = Function; C = Constant

Table 21–2. TCP APIs (Continued)

Syntax	Type	Description	See page ...
TCP_interleaveExt	F	Interleaves extrinsics data for shared processing mode	21-26
TCP_makeTailArgs	F	Builds the Tail values used for IC6–IC11	21-27
TCP_MAP_MAP1A	C	Value indicating that the first iteration of a MAP1 decoding	21-27
TCP_MAP_MAP1B	C	Value indicating a MAP1 decoding (any iteration after the first)	21-27
TCP_MAP_MAP2	C	Value indicating a MAP2 decoding	21-27
TCP_MODE_SA	C	Value indicating standalone processing mode	21-28
TCP_MODE_SP	C	Value indicating shared processing mode	21-28
TCP_normalCeil	F	Normalized ceiling function	21-28
TCP_pause	F	Pauses the TCP	21-28
TCP_RATE_1_2	C	Value indicating a rate of 1/2	21-28
TCP_RATE_1_3	C	Value indicating a rate of 1/3	21-29
TCP_RATE_1_4	C	Value indicating a rate of 1/4	21-29
TCP_RLEN_MAX	C	Maximum reliability length	21-29
TCP_setAprioriEndian	F	Sets the Apriori data endian configuration	21-29
TCP_setExtEndian	F	Sets the Extrinsics data endian configuration	21-30
TCP_setInterEndian	F	Sets the Interleaver Table data endian configuration	21-30
TCP_setNativeEndian	F	Sets all data formats to be native (not packed data)	21-31
TCP_setPacked32Endian	F	Sets all data formats to be packed data	21-31
TCP_setParams	F	Generates IC0–IC5 based on the channel parameters	21-31
TCP_setSysParEndian	F	Sets the Systematics and Parities data endian configuration	21-32
TCP_STANDARD_3GPP	C	Value indicating the 3GPP standard	21-32
TCP_STANDARD_IS2000	C	Value indicating the IS2000 standard	21-32
TCP_start	F	Starts the TCP	21-33
TCP_statError	F	Returns the error status	21-33

Note: F = Function; C = Constant

Table 21–2. TCP APIs (Continued)

Syntax	Type	Description	See page ...
TCP_statPause	F	Returns the pause status	21-33
TCP_statRun	F	Returns the run status	21-34
TCP_statWaitApriori	F	Returns the Apriori data status	21-34
TCP_statWaitExt	F	Returns the Extrinsic data status	21-34
TCP_statWaitHardDec	F	Returns the Hard Decisions status	21-35
TCP_statWaitIc	F	Returns the IC values status	21-35
TCP_statWaitInter	F	Returns the Interleaver Table status	21-35
TCP_statWaitOutParm	F	Returns the Output Parameters status	21-36
TCP_statWaitSysPar	F	Returns the Systematics and Parities data status	21-36
TCP_tailConfig	F	Generates IC6–IC11 by calling either TCP_tailConfig3GPP or TCP_tailConfigIS2000	21-37
TCP_tailConfig3GPP	F	Generates tail values for 3GPP channel data	21-38
TCP_tailConfigIS2000	F	Generates tail values for IS2000 channel data	21-39
TCP_unpause	F	Unpauses the TCP	21-40

Note: F = Function; C = Constant

21.1.1 Using the TCP

To use the TCP, you must first configure the control values, or IC values, that will be sent via the EDMA to program its operation. To do this, the `TCP_Params` structure and `TCP_XabData` pointer are passed to `TCP_icConfig()`. `TCP_Params` contains all of the channel characteristics and `TCP_XabData` is a pointer to the tail data located at the end of the received channel data. This configuration function returns a pointer to the IC values that are to be sent using the EDMA. If desired, the configuration function can be bypassed and the user can generate each IC value independently, using several `TCP_RMK` (make) macros that construct register values based on field values. In addition, the symbol constants may be used for the field values.

When operating in big endian mode, the CPU must configure the format of all the data to be transferred to and from the TCP. This is accomplished by programming the TCP Endian register (`TCP_END`). Typically, the data will all be of the same format, either following the native element size (either 8-bit or

16-bit) or being packed into a 32-bit word. This being the case, the endian mode values can be set using a single function call to either `TCP_setNativeEndian()` or `TCP_setPacked32Endian()`. Alternatively, the data format of individual data types can be programmed with independent functions.

The user can monitor the status of the TCP during operation and also monitor error flags if there is a problem.

21.2 Macros

There are two types of TCP macros: those that access registers and fields, and those that construct register and field values. These are not required as all TCP configuring and monitoring can be done through the provided functions. These TCP functions make use of a number of macros.

Table 21–3 lists the TCP macros that access registers and fields. Table 21–4 lists the TCP macros that construct register and field values. The macros themselves are found in Chapter 28, *Using the HAL Macros*.

The TCP module includes handle-based macros.

Table 21–3. TCP Macros that Access Registers and Fields

Macro	Description/Purpose	See page ...
TCP_ADDR(<REG>)	Register address	28-12
TCP_RGET(<REG>)	Returns the value in the peripheral register	28-18
TCP_RSET(<REG>,x)	Register set	28-20
TCP_FGET(<REG>,<FIELD>)	Returns the value of the specified field in the peripheral register	28-13
TCP_FSET(<REG>,<FIELD>,fieldval)	Writes <i>fieldval</i> to the specified field in the peripheral register	28-15
TCP_FSETS(<REG>,<FIELD>,<SYM>)	Writes the symbol value to the specified field in the peripheral	28-17
TCP_RGETA(addr,<REG>)	Gets register for a given address	28-19
TCP_RSETA(addr,<REG>,x)	Sets register for a given address	28-20
TCP_FGETA(addr,<REG>,<FIELD>)	Gets field for a given address	28-13
TCP_FSETA(addr,<REG>,<FIELD>,fieldval)	Sets field for a given address	28-16
TCP_FSETSA(addr,<REG>,<FIELD>,<SYM>)	Sets field symbolically for a given address	28-17

Table 21–4. TCP Macros that Construct Register and Field Values

Macro	Description/Purpose	See page ...
TCP_<REG>_DEFAULT	Register default value	28-21
TCP_<REG>_RMK()	Register make	28-23
TCP_<REG>_OF()	Register value of ...	28-22
TCP_<REG>_<FIELD>_DEFAULT	Field default value	28-24
TCP_FMK()	Field make	28-14
TCP_FMKS()	Field make symbolically	28-15
TCP_<REG>_<FIELD>_OF()	Field value of ...	28-24
TCP_<REG>_<FIELD>_<SYM>	Field symbolic value	28-24

TCP_BaseParams

21.3 Configuration Structures

TCP_BaseParams *Structure used to set basic TCP Parameters*

Structure	TCP_BaseParams																
Members	<table><tr><td>TCP_Standard</td><td>standard; TCP Decoded Standard3GPP/IS2000</td></tr><tr><td>TCP_Rate</td><td>rate; Code rate</td></tr><tr><td>Uint16</td><td>frameLen; Frame Length</td></tr><tr><td>Uint8</td><td>prologSize; Prolog Size</td></tr><tr><td>Uint8</td><td>maxIter; Maximum Iteration</td></tr><tr><td>Uint8</td><td>snr; SNR Threshold</td></tr><tr><td>Uint8</td><td>intFlag; Interleaver flag</td></tr><tr><td>Uint8</td><td>outParmFlag Output Parameter read flag</td></tr></table>	TCP_Standard	standard; TCP Decoded Standard3GPP/IS2000	TCP_Rate	rate; Code rate	Uint16	frameLen; Frame Length	Uint8	prologSize; Prolog Size	Uint8	maxIter; Maximum Iteration	Uint8	snr; SNR Threshold	Uint8	intFlag; Interleaver flag	Uint8	outParmFlag Output Parameter read flag
TCP_Standard	standard; TCP Decoded Standard3GPP/IS2000																
TCP_Rate	rate; Code rate																
Uint16	frameLen; Frame Length																
Uint8	prologSize; Prolog Size																
Uint8	maxIter; Maximum Iteration																
Uint8	snr; SNR Threshold																
Uint8	intFlag; Interleaver flag																
Uint8	outParmFlag Output Parameter read flag																
Description	This is the TCP base parameters structure used to set up the TCP programmable parameters. You create the object and pass it to the TCP_genParams() function which returns the TCP_Params structure.																

Example

```
TCP_BaseParams tcpBaseParam0 = {
    TCP_STANDARD_3GPP, /* Decoder Standard */
    TCP_RATE_1_3,      /* Rate */
    40, /*Frame Length (FL: 40 to 20730)*/
    24, /*Prolog Size (P: 24 to 48) */
    8, /*Max of Iterations (MAXIT-SA mode only)*/
    0, /*SNR Threshold (SNR - SA mode only) */
    1, /*Interleaver Write Flag */
    1 /*Output Parameters Read Flag */
};
TCP_genParams(&tcpBaseParam0, &tcpParam0);
```

TCP_ConfigIc*Structure containing the IC register values***Structure**

```
typedef struct {
    Uint32 ic0;
    Uint32 ic1;
    Uint32 ic2;
    Uint32 ic3;
    Uint32 ic4;
    Uint32 ic5;
    Uint32 ic6;
    Uint32 ic7;
    Uint32 ic8;
    Uint32 ic9;
    Uint32 ic10;
    Uint32 ic11;
} TCP_ConfigIc;
```

Members

ic0	Input Configuration word 0 value
ic1	Input Configuration word 1 value
ic2	Input Configuration word 2 value
ic3	Input Configuration word 3 value
ic4	Input Configuration word 4 value
ic5	Input Configuration word 5 value
ic6	Input Configuration word 6 value
ic7	Input Configuration word 7 value
ic8	Input Configuration word 8 value
ic9	Input Configuration word 9 value
ic10	Input Configuration word 10 value
ic11	Input Configuration word 11 value

Description

This is the TCP input configuration structure that holds all of the configuration values that are to be transferred to the TCP via the EDMA. Though using the EDMA is highly recommended, the values can be written to the TCP using the CPU with the `TCP_icConfig()` function.

Example

```
extern TCP_Params *params;
extern TCP_UserData *xabData;
TCP_ConfigIc *config;
...
TCP_genIc(params, xabData, config);
...
```

TCP_Params

TCP_Params

Structure containing all channel characteristics

Structure

```
typedef struct {
    TCP_Standard standard;
    TCP_Mode mode;
    TCP_Map map;
    TCP_Rate rate;
    Uint32 intFlag;
    Uint32 outParmFlag;
    Uint32 frameLen;
    Uint32 subFrameLen;
    Uint32 relLen;
    Uint32 relLenLast;
    Uint32 prologSize;
    Uint32 numSubBlock;
    Uint32 numSubBlockLast;
    Uint32 maxIter;
    Uint32 snr;
    Uint32 numInter;
    Uint32 numSysPar;
    Uint32 numApriori;
    Uint32 numExt;
    Uint32 numHd;
} TCP_Params;
```

Members	standard	The 3G standard used: 3GPP or IS2000 The available constants are: <input type="checkbox"/> TCP_STANDARD_3GPP <input type="checkbox"/> TCP_STANDARD_IS2000
	mode	The processing mode: Shared or Standalone The available constants are: <input type="checkbox"/> TCP_MODE_SA <input type="checkbox"/> TCP_MODE_SP
	map	The map mode constants are: <input type="checkbox"/> TCP_MAP_MAP1A <input type="checkbox"/> TCP_MAP_MAP1B <input type="checkbox"/> TCP_MAP_MAP2
	rate	The rate: 1/2, 1/3,1/4 The rate constants are: <input type="checkbox"/> TCP_RATE_1_2 <input type="checkbox"/> TCP_RATE_1_3 <input type="checkbox"/> TCP_RATE_1_4
	intFlag	Interleaver write flag
	outParmFlag	Output parameters flag
	frameLen	Number of symbols in the frame to be decoded
	subFrameLen	The number of symbols in a sub-frame
	relLen	Reliability length
	relLenLast	Reliability length of the last sub-frame
	prologSize	Prolog Size
	numSubBlock	Number of sub-blocks
	numSubBlockLast	Number of sub-blocks in the last sub-frame
maxIter	Maximum number of iterations	
snr	Signal to noise ratio threshold	
numInter	Number of interleaver words per event	
numSysPar	Number of systematics and parities words per event	
numApriori	Number of apriori words per event	
numExt	Number of extrinsics per event	
numHd	Number of hard decisions words per event	

TCP_Params

Description

This is the TCP parameters structure that holds all of the information concerning the user channel. These values are used to generate the appropriate input configuration values for the TCP and to program the EDMA.

Example

```
extern TCP_Params *params;
extern TCP_UserData *xabData;
TCP_ConfigIc *config;
...
TCP_genIc(params, xabData, config);
...
```

21.4 Functions

TCP_calcSubBlocksSA *Calculates sub-blocks for standalone processing*

Function	void TCP_calcSubBlocksSA(TCP_Params *configParms);
Arguments	ConfigParms Configuration parameters
Return Value	none
Description	Divides the data frames into sub-blocks for standalone processing mode.
Example	<pre>TCP_calcSubBlocksSA(configParms);</pre>

TCP_calcSubBlocksSP *Calculates sub-blocks for shared processing*

Function	UInt32 TCP_calcSubBlocksSP(TCP_Params *configParms);
Arguments	ConfigParms Configuration parameters
Return Value	numSubFrames Number of sub-frames
Description	Divides the data frames into sub-frames and sub-blocks for shared processing mode. The number of subframes into which the data frame was divided is returned.
Example	<pre>UInt32 numSubFrames; numSubFrames = TCP_calcSubBlocksSP(configParms);</pre>

TCP_calcCountsSA *Calculates the count values for standalone processing*

Function	Void TCP_calcCountsSA(TCP_Params *configParms);
Arguments	configParms Configuration parameters
Return Value	none
Description	This function calculates all of the count values required to transfer all data to/from the TCP using the EDMA. This function is for standalone processing mode.
Example	<pre>TCP_calcCountsSA(configParms);</pre>

TCP_calcCountsSP *Calculates the count values for shared processing*

Function	Void TCP_calcCountsSP(TCP_Params *configParms);
Arguments	configParms Configuration parameters

TCP_calculateHd

Return Value	none
Description	This function calculates all of the count values required to transfer all data to/from the TCP using the EDMA. This function is for shared processing mode.
Example	<pre>TCP_calcCountsSP(configParms);</pre>

TCP_calculateHd *Calculate hard decisions*

Function	<pre>void TCP_calculateHd(const TCP_ExtrinsicData *restrict extrinsicsMap1, const TCP_ExtrinsicData *restrict apriori, const TCP_UserData *restrict channel_data, Uint32 *restrict hardDecisions, Uint16 numExt, Uint8 rate);</pre>	
Arguments	extrinsicsMap1	Extrinsics data following MAP1 decode
	apriori	Apriori data following MAP2 decode
	channel_data	Input channel data
	harddecisions	Hard decisions
	numext	Number of extrinsics
	rate	Channel rate
Return Value	none	
Description	This function calculates the hard decisions following multiple MAP decodings in shared processing mode.	
Example	<pre><...Iterate through MAP1 and MAP2 decodes...> void TCP_calculateHd(extrinsicsMap1, apriori, channel_data, hardDecisions, numExt, rate);</pre>	

TCP_ceil *Ceiling function*

Function	<pre>Uint32 TCP_ceil(Uint32 val, Uint32 pwr2);</pre>	
Arguments	val	Value to be augmented
	pwr2	The power of two by which val must be divisible
Return Value	ceilVal	The smallest number which when multiplied by 2^{pwr2} is greater than val.
Description	This function calculates the ceiling for a given value and a power of 2. The arguments follow the formula: $ceilVal * 2^{pwr2} = ceiling(val, pwr2)$.	

Example numSysPar = TCP_ceil((frameLen * rate), 4);

TCP_deinterleaveExt *De-interleave extrinsics data*

Function Void TCP_deinterleaveExt(
 TCP_ExtrinsicData *restrict aprioriMap1,
 const TCP_ExtrinsicData *restrict extrinsicsMap2,
 const Uint16 *restrict interleaverTable,
 Uint32 numExt);

Arguments

aprioriMap1	Apriori data for MAP1 decode
extrinsicsMap2	Extrinsics data following MAP2 decode
interleaverTable	Interleaver data table
numExt	Number of Extrinsics

Return Value none

Description This function de-interleaves the MAP2 extrinsics data to generate apriori data for the MAP1 decode. This function is for use in performing shared processing.

Example

```
<...MAP 2 decode...>
TCP_deinterleaveExt(aprioriMap2, extrinsicsMap1,
                    interleaverTable, numExt);
<...MAP 1 decode...>
```

TCP_demuxInput *Demultiplexes the input data*

Function Void TCP_demuxInput(Uint32 rate,
 Uint32 frameLen,
 const TCP_UserData *restrict input,
 const Uint16 *restrict interleaver,
 TCP_ExtrinsicData *restrict nonInterleaved,
 TCP_ExtrinsicData *restrict interleaved);

Arguments

rate	Channel rate
frameLen	Frame length
input	Input channel data
interleaver	Interleaver data table
nonInterleaved	Non-interleaved input data
interleaved	Interleaved input data

TCP_END_NATIVE

Return Value	none
Description	This function splits the input data into two working sets. One set contains the non-interleaved input data and is used with the MAP 1 decoding. The other contains the interleaved input data and is used with the MAP2 decoding. This function is used in shared processing mode.
Example	<pre>TCP_demuxInput(rate, frameLen, input, interleaver, nonInterleaved, interleaved);</pre>

TCP_END_NATIVE *Value indicating native endian format*

Constant	TCP_END_NATIVE
Description	This constant allows selection of the native format for all data transferred to and from the TCP. That is to say that all data is contiguous in memory with incrementing addresses.

TCP_END_PACKED32 *Value indicating little endian format within packed 32-bit words*

Constant	TCP_END_PACKED32
Description	This constant allows selection of the packed 32-bit format for data transferred to and from the TCP. That is to say that all data is packed into 32-bit words in little endian format and these words are contiguous in memory.

TCP_errTest *Returns the error code*

Function	UInt32 TCP_errTest();
Arguments	none
Return Value	Error code Code error value
Description	Returns an ERR bit indicating what TCP error has occurred.
Example	<pre>/* check whether an error has occurred */ if (TCP_errorStat()){ error = TCP_ErrGet(); } /* end if */</pre>

TCP_FLEN_MAX *Maximum frame length*

Constant	TCP_FLEN_MAX
Description	This constant equals the maximum frame length programmable into the TCP.

TCP_genIc *Generates the TCP_ConfigIc structure*

Function	void TCP_genIc(TCP_Params *restrict configParms, TCP_UserData *restrict xabData, TCP_ConfigIc *restrict configIc)
Arguments	configParms Pointer to Channel parameters structure xabData Pointer to tail values at the end of the channel data configIc Pointer to Input Configuration structure
Return Value	none
Description	Generates the required input configuration values needed to program the TCP based on the parameters provided by configParms.
Example	<pre>extern TCP_Params *params; extern TCP_UserData *xabData; TCP_ConfigIc *config; ... TCP_genIc(params, xabData, config); ...</pre>

TCP_genParams *Sets basic TCP Parameters*

Function	UInt32 TCP_genParams(TCP_BaseParams *configBase, TCP_Params *configParams)
Arguments	configBase Pointer to TCP_BaseParams structure configParams Output TCP_Params structure pointer
Return Value	number of sub-blocks
Description	Copies the basic parameters under the output TCP_Params parameters structure and returns the number of sub-blocks.

TCP_getAccessErr

Example

```
Uint32 numSubblk;
TCP_Params tcpParam0;
TCP_ConfigIc *config;
numSubblk = TCP_genParams(&tcpBaseParam0, &tcpParam0);
```

TCP_getAccessErr *Returns access error flag*

Function Uint32 TCP_getAccessErr();

Arguments none

Return Value Error value of access error bit

Description Returns the ACC bit value indicating whether an invalid access has been made to the TCP during operation.

Example

```
/* check whether an invalid access has been made */
if (TCP_getAccessErr()){
    ...
} /* end if */
```

TCP_getAprioriEndian *Returns Apriori data endian configuration*

Function Uint32 TCP_getAprioriEndian();

Arguments none

Return Value Endian Endian setting for apriori data

Description Returns the value programmed into the TCP_END register for the apriori data indicating whether the data is in its native 8-bit format ('1') or consists of values packed in little endian format into 32-bit words ('0'). This should always be '0' for little endian operation.

See also TCP_aprioriEndianSet, TCP_nativeEndianSet, TCP_packed32EndianSet, TCP_extEndianGet, TCP_interEndianGet, TCP_sysParEndianGet, TCP_extEndianSet, TCP_interEndianSet, TCP_sysParEndianSet.

Example

```
If (TCP_getAprioriEndian()){
    ...
} /* end if */
```

TCP_getExtEndian *Returns the Extrinsics data endian configuration*

Function	Uint32 TCP_getExtEndian();
Arguments	none
Return Value	Endian Endian setting for extrinsics data
Description	<p>Returns the value programmed into the TCP_END register for the extrinsics data indicating whether the data is in its native 8-bit format ('1') or consists of values packed in little endian format into 32-bit words ('0'). This should always be '0' for little endian operation.</p> <p>See also TCP_setExtEndian, TCP_setNativeEndian, TCP_setPacked32Endian, TCP_getAprioriEndian, TCP_getInterEndian, TCP_getSysParEndian, TCP_setAprioriEndian, TCP_setInterEndian, TCP_setSysParEndian.</p>
Example	<pre>If (TCP_getExtEndian()){ ... } /* end if */</pre>

TCP_getFrameLenErr *Returns the frame length error status*

Function	Uint32 TCP_getFrameLenErr();
Arguments	none
Return Value	Error flag Boolean indication of frame length error
Description	Returns a Boolean value indicating whether an invalid frame length has been programmed in the TCP during operation.
Example	<pre>/* check whether an invalid access has been made */ if (TCP_getFrameLenErr()){ ... } /* end if */</pre>

TCP_getIcConfig *Returns the IC values already programmed into the TCP*

Function	void TCP_getIcConfig(TCP_ConfigIc *config)
Arguments	config Pointer to Input Configuration structure

TCP_getInterEndian

Return Value	none
Description	Reads the input configuration values currently programmed into the TCP.
Example	<pre>TCP_ConfigIc *config; ... TCP_getIcConfig(config); ...</pre>

TCP_getInterEndian *Returns the interleaver table data endian*

Function	Uint32 TCP_getInterEndian();
Arguments	none
Return Value	Endian Endian setting for interleaver table data
Description	<p>Returns the value programmed into the TCP_END register for the interleaver table data indicating whether the data is in its native 8-bit format ('1') or consists of values packed in little endian format into 32-bit words ('0'). This should always be '0' for little endian operation.</p> <p>See also TCP_setExtEndian, TCP_setNativeEndian, TCP_setPacked32Endian, TCP_getAprioriEndian, TCP_getExtEndian, TCP_getSysParEndian, TCP_setAprioriEndian, TCP_setInterEndian, TCP_setSysParEndian.</p>
Example	<pre>If (TCP_getInterEndian()){ ... } /* end if */</pre>

TCP_getInterleaveErr *Returns the interleaver table error status*

Function	Uint32 TCP_getInterleaveErr();
Arguments	none
Return Value	Error flag value of interleaver table error bit
Description	<p>Returns an INTER value bit indicating whether the TCP was incorrectly programmed to receive an interleaver table. An interleaver table can only be sent when operating in standalone mode. This bit indicates if an interleaver table was sent when in shared processing mode.</p>

Example

```

/* check whether the TCP was programmed to receive
   an interleaver table when in shared processing
   mode. */
if (TCP_getInterleaveErr()){
    ...
} /* end if */

```

TCP_getLastRelLenErr *Returns the error status for a bad reliability length*

Function Uint32 TCP_getLastRelLenErr();

Arguments none

Return Value Error flag value of an error for the reliability length of the last subframe (LR bit)

Description Returns the LR bit value indicating whether the TCP was programmed with a bad reliability length for the last subframe. The reliability length must be greater than or equal to 40 to be valid.

Example

```

/* check whether the TCP was programmed with a bad
   reliability length for the last frame. */
if (TCP_getLastRelLenErr()){
    ...
} /* end if */

```

TCP_getModeErr *Returns the error status for a bad TCP mode*

Function Uint32 TCP_getModeErr();

Arguments none

Return Value Error flag Value of mode error bit

Description Returns the MODE bit value indicating whether an invalid MAP mode was programmed into the TCP. Only values of 4, 5, and 7 are valid.

Example

```

/* check whether the TCP was programmed using an
   invalid mode. */
if (TCP_getModeErr()){
    ...
} /* end if */

```

TCP_getNumIt

TCP_getNumIt *Returns the number of iterations performed by the TCP*

Function Uint32 TCP_getNumIt();

Arguments none

Return Value iterations The number of iterations performed by the TCP

Description Returns the number of iterations executed by the TCP in standalone processing mode. This function reads the output parameters register. Alternatively, the EDMA can be used to transfer the output parameters following the hard decisions (recommended).

Example

```
numIter = TCP_getNumIt();
```

TCP_getOutParmErr *Returns the output parameter*

Function Uint32 TCP_getOutParmErr();

Arguments none

Return Value Error flag value of output parameters error

Description Returns the OP bit value indicating whether the TCP was programmed to transfer output parameters in shared processing mode. The output parameters are only valid when operating in standalone mode.

Example

```
/* check whether the TCP was programmed to provide
   output parameters when in Shared Processing mode. */
if (TCP_getOutParmErr()){
    ...
} /* end if */
```

TCP_getProlLenErr *Returns the error status for an invalid prolog length*

Function Uint32 TCP_getProlLenErr();

Arguments none

Return Value Error flag Value of Prolog Length error

Description Returns the P bit value indicating whether an invalid prolog length has been programmed into the TCP.

Example

```
/* check whether an invalid prolog length has been
   programmed. */
if (TCP_getProlLenErr()){
    ...
} /* end if */
```

TCP_getRateErr *Returns the error status for an invalid rate*

Function	Uint32 TCP_getRateErr();
Arguments	none
Return Value	Error flag Value of rate error
Description	Returns the RATE bit value indicating whether an invalid rate has been programmed into the TCP.
Example	<pre>/* check whether an invalid rate has been programmed */ if (TCP_getRateErr()){ ... } /* end if */</pre>

TCP_getRelLenErr *Returns the error status for and invalid reliability length*

Function	Uint32 TCP_getRelLenErr();
Arguments	none
Return Value	Error flag Value of reliability length error
Description	Returns the R bit value indicating whether an invalid reliability length has been programmed into the TCP.
Example	<pre>/* check whether an invalid reliability length has been programmed. */ if (TCP_getRelLenErrG()){ ... } /* end if */</pre>

TCP_getSubFrameErr *Returns sub-frame error flag*

Function	Uint32 TCP_getSubFrameErr();
Arguments	none
Return Value	Error flag Boolean indication of sub-frame error
Description	Returns a Boolean value indicating whether the sub-frame length programmed into the TCP is invalid.
Example	<pre>/* check whether an invalid sub-frame length has been programmed. */ if (TCP_getSubFrameErr()){ ... } /* end if */</pre>

TCP_getSysParEndian

TCP_getSysParEndian *Returns Systematics and Parities data endian configuration*

Function `Uint32 TCP_getSysParEndian();`

Arguments `none`

Return Value `Endian` Endian setting for systematics and parities data

Description Returns the value programmed into the TCP_END register for the systematics and parities data, indicating whether the data is in its native 8-bit format ('1') or consists of values packed in little endian format into 32-bit words ('0'). This should always be '0' for little endian operation.

See also `TCP_setSysParEndian`, `TCP_setNativeEndian`, `TCP_setPacked32Endian`.

Example

```
if (TCP_getSysParEndian()) {
    ...
} /* end if */
```

TCP_icConfig *Stores the IC values into the TCP*

Function `void TCP_icConfig(TCP_ConfigIc *config)`

Arguments `Config` Pointer to Input Configuration structure

Return Value `none`

Description Stores the input configuration values currently programmed into the TCP. This is not the recommended means by which to program the TCP, as it is more efficient to transfer the IC values using the EDMA, but can be used in test code.

Example

```
extern TCP_Params *params;
extern TCP_UserData *xabData;
TCP_ConfigIc *config;
...
TCP_genIc(params, xabData, config);
TCP_icConfig(config);
...

```

TCP_icConfigArgs *Stores the IC values into the TCP using arguments*

Function	Void TCP_icConfigArgs(Uin32 ic0, Uin32 ic1, Uin32 ic2, Uin32 ic3, Uin32 ic4, Uin32 ic5, Uin32 ic6, Uin32 ic7, Uin32 ic8, Uin32 ic9, Uin32 ic10, Uin32 ic11)
Arguments	ic0 Input Configuration word 0 value ic1 Input Configuration word 1 value ic2 Input Configuration word 2 value ic3 Input Configuration word 3 value ic4 Input Configuration word 4 value ic5 Input Configuration word 5 value ic6 Input Configuration word 6 value ic7 Input Configuration word 7 value ic8 Input Configuration word 8 value ic9 Input Configuration word 9 value ic10 Input Configuration word 10 value ic11 Input Configuration word 11 value
Return Value	none
Description	Stores the input configuration values currently programmed into the TCP. This is not the recommended means by which to program the TCP, as it is more efficient to transfer the IC values using the EDMA, but can be used in test code.

TCP_interleaveExt

Example

```
TCP_icConfigArgs (
    0x00283200      /* IC0 */
    0x00270000      /* IC1 */
    0x00080118      /* IC2 */
    0x001E0014      /* IC3 */
    0x00000000      /* IC4 */
    0x00000002      /* IC5 */
    0x00E3E6F2      /* IC6 */
    0x00E40512      /* IC7 */
    0x00000000      /* IC8 */
    0x00F5FA1E      /* IC9 */
    0x00F00912      /* IC10 */
    0x00000000      /* IC11 */
);
```

TCP_interleaveExt *Interleaves extrinsics data*

Function

```
Void TCP_interleaveExt(
    TCP_ExtrinsicData *restrict aprioriMap2,
    const TCP_ExtrinsicData *restrict extrinsicsMap1,
    const Uint16 *restrict interleaverTable,
    Uint32 numExt);
```

Arguments

aprioriMap2	Apriori data for MAP2 decode
extrinsicsMap1	Extrinsics data following MAP1 decode
interleaverTable	Interleaver data table
NumExt	Number of Extrinsics

Return Value

none

Description

This function interleaves the MAP1 extrinsics data to generate apriori data for the MAP2 decode. This function is for use in performing shared processing.

Example

```
<...MAP 1 decode...>
TCP_interleaveExt(aprioriMap2, extrinsicsMap1,
                  InterleaverTable, numExt);
<...MAP 2 decode...>
```

TCP_makeTailArgs *Generates the Tail values used for ICCIC11*

Function	<pre> Uint32 TCP_makeTailArgs(Uint8 byte31_24, Uint8 byte23_16, Uint8 byte15_8, Uint8 byte7_0) </pre>	
Arguments	byte31_24	Byte to be placed in bits 31–24 of the 32-bit value
	byte23_16	Byte to be placed in bits 23–16 of the 32-bit value
	byte15_8	Byte to be placed in bits 15–8 of the 32-bit value
	byte7_0	Byte to be placed in bits 7–0 of the 32-bit value
Return Value	none	
Description	Formats individual bytes into a 32-bit word	
Example	<pre> tail1 = TCP_makeTailArgs(0 , xabData[10], xabData[8], xabData[6]); </pre>	

TCP_MAP_MAP1A *Value indicating the first iteration of a MAP1 decoding*

Constant	TCP_MAP_MAP1A
Description	This constant allows selection of the Map 1 decoding mode used when operating in shared processing mode on the first iteration through the data. The first iteration through the Map 1 decoding is unique in that no apriori data is set to the TCP.

TCP_MAP_MAP1B *Value indicating a MAP1 decoding (any iteration after the first)*

Constant	TCP_MAP_MAP1B
Description	This constant allows selection of the Map 1 decoding mode used when operating in shared processing mode on any but the first iteration through the data. The first iteration through the Map 1 decoding is unique in that no apriori data is set to the TCP.

TCP_MAP_MAP2 *Value indicating a MAP2 decoding*

Constant	TCP_MAP_MAP2
Description	This constant allows selection of the Map 2 decoding mode used when operating in shared processing mode.

TCP_MODE_SA

TCP_MODE_SA *Value indicating standalone processing*

Constant	TCP_MODE_SA
Description	This constant allows selection of standalone processing mode.

TCP_MODE_SP *Value indicating shared processing mode*

Constant	TCP_MODE_SP
Description	This constant allows selection of shared processing mode.

TCP_normalCeil *Normalized ceiling function*

Function	UInt32 TCP_normalCeil(UInt32 val1, UInt32 val2) ;
Arguments	val1 Value to be augmented val2 Value by which val1 must be divisible
Return Value	ceilVal The smallest number greater than or equal to val1 that is divisible by val2.
Description	Returns the smallest number greater than or equal to val1 that is divisible by val2.
Example	<pre>winSize = TCP_normalCeil(winSize, numSlidingWindow);</pre>

TCP_pause *Pauses the TCP by writing a '1' to the pause bit in TCP_EXE*

Function	void TCP_pause();
Arguments	none
Return Value	none
Description	This function pauses the TCP by writing a '1' to the PAUSE field of the TCP_EXE register. See also TCP_start() and TCP_unpause().
Example	<pre>TCP_pause();</pre>

TCP_RATE_1_2 *Value indicating a rate of 1/2*

Constant	TCP_RATE_1_2
Description	This constant allows selection of a rate of 1/2.

TCP_RATE_1_3 *Value indicating a rate of 1/3*

Constant	TCP_RATE_1_3
Description	This constant allows selection of a rate of 1/3.

TCP_RATE_1_4 *Value indicating a rate of 1/4*

Constant	TCP_RATE_1_4
Description	This constant allows selection of a rate of 1/4.

TCP_RLEN_MAX *Maximum reliability length*

Constant	TCP_RLEN_MAX
Description	This constant equals the maximum reliability length programmable into the TCP.

TCP_setAprioriEndian *Sets Apriori data endian configuration*

Function	Void TCP_setAprioriEndian(UINT32 endianMode);
Arguments	Endian Endian setting for apriori data
Return Value	none
Description	<p>This function programs TCP to view the format of the apriori data as either native 8-bit format ('1') or values packed into 32-bit words in little endian format ('0'). This should always be '0' for little endian operation.</p> <p>See also TCP_getAprioriEndian, TCP_setNativeEndian, TCP_setPacked32Endian, TCP_getExtEndian, TCP_getInterEndian, TCP_getSysParEndian, TCP_setExtEndian, TCP_setInterEndian, TCP_setSysParEndian.</p>
Example	<pre>TCP_setAprioriEndian(TCP_END_PACKED32);</pre>

TCP_setExtEndian

TCP_setExtEndian *Sets the Extrinsics data endian configuration*

Function	Void TCP_setExtEndian(UINT32 endianMode);
Arguments	Endian Endian setting for extrinsics data
Return Value	none
Description	<p>This function programs TCP to view the format of the extrinsics data as either native 8-bit format ('1') or values packed into 32-bit words in little endian format ('0'). This should always be '0' for little endian operation.</p> <p>See also TCP_getExtEndian, TCP_setNativeEndian, TCP_setPacked32Endian, TCP_getAprioriEndian, TCP_getInterEndian, TCP_getSysParEndian, TCP_setAprioriEndian, TCP_setInterEndian, TCP_setSysParEndian.</p>
Example	<pre>TCP_setAprioriEndian(TCP_END_PACKED32);</pre>

TCP_setInterEndian *Sets the interleaver table data endian*

Function	Void TCP_setInterEndian(UINT32 endianMode);
Arguments	Endian Endian setting for interleaver table data The following constants can be used: <input type="checkbox"/> TCP_END_PACKED32 or 0 <input type="checkbox"/> TCP_END_NATIVE or 1
Return Value	none
Description	<p>This function programs TCP to view the format of the interleaver table data as either native 8-bit format ('1') or values packed into 32-bit words in little endian format ('0'). This should always be '0' for little endian operation.</p> <p>See also TCP_getInterEndian, TCP_setNativeEndian, TCP_setPacked32Endian, TCP_getAprioriEndian, TCP_getExtEndian, TCP_getSysParEndian, TCP_setAprioriEndian, TCP_setExtEndian, TCP_setSysParEndian.</p>
Example	<pre>TCP_setInterEndian(TCP_END_PACKED32);</pre>

TCP_setNativeEndian *Sets all data formats to be native (not packed)*

Function	void TCP_setNativeEndian();
Arguments	none
Return Value	none
Description	<p>This function programs the TCP to view the format of all data as native 8-/16-bit format. This should only be used when running in big endian mode.</p> <p>See also TCP_setExtEndian, TCP_setPacked32Endian, TCP_getAprioriEndian, TCP_getExtEndian, TCP_getSysParEndian, TCP_setAprioriEndian, TCP_setInterEndian, TCP_setSysParEndian.</p>
Example	TCP_setNativeEndian();

TCP_setPacked32Endian *Sets all data formats to packed data*

Function	void TCP_setPacked32Endian();
Arguments	none
Return Value	none
Description	<p>This function programs the TCP to view the format of all data as packed data in 32-bit words. This should always be used when running in little endian mode and should be used in big endian mode only if the CPU is formatting the data.</p> <p>See also TCP_setNativeEndian, TCP_setExtEndian, TCP_getAprioriEndian, TCP_getExtEndian, TCP_getSysParEndian, TCP_setAprioriEndian, TCP_setInterEndian, TCP_setSysParEndian.</p>
Example	TCP_setPacked32Endian();

TCP_setParams *Generates IC0–C5 based on channel parameters*

Function	void TCP_setParams(TCP_Params *configParms, TCP_Configlc *configlc);
Arguments	configParms Pointer to the user channel parameters structure configlc Pointer to the IC values structure

TCP_setSysParEndian

Return Value	none
Description	This function generates the input control values IC0–IC5 based on the user channel parameters contained in the <code>configParms</code> structure.
Example	<pre>extern TCP_Params *configParms; TCP_ConfigIc *configIC; ... TCP_setParams(configParms, configIc);</pre>

TCP_setSysParEndian *Sets Systematics and Parities data endian configuration*

Function	Void TCP_setSysParEndian(Uint32 endianMode);
Arguments	Endian Endian setting for systematics and parities data
Return Value	none
Description	<p>This function programs the TCP to view the format of the systematics and parities data as either native 8-bit format ('1') or values packed into 32-bit words in little endian format ('0'). This should always be '0' for little endian operation.</p> <p>See also <code>TCP_getSysParEndian</code>, <code>TCP_setNativeEndian</code>, <code>TCP_setPacked32Endian</code>.</p>
Example	<pre>TCP_setSysParEndian(TCP_END_PACKED32);</pre>

TCP_STANDARD_3GPP *Value indicating the 3GPP standard*

Constant	TCP_STANDARD_3GPP
Description	This constant allows selection of the 3GPP standard.

TCP_STANDARD_IS2000 *Value indicating the IS2000 standard*

Constant	TCP_STANDARD_IS2000
Description	This constant allows selection of the IS2000 standard.

TCP_start*Starts the TCP by writing a '1' to the start bit in TCP_EXE*

Function	void TCP_start();
Arguments	none
Return Value	none
Description	This function starts the TCP by writing a '1' to the START field of the TCP_EXE register. See also TCP_pause() and TCP_unpause().
Example	<pre>TCP_start();</pre>

TCP_statError*Returns the error status*

Function	Uint32 TCP_statError();
Arguments	none
Return Value	Error status Value of error bit
Description	Returns the ERR bit value indicating whether any TCP error has occurred.
Example	<pre>/* check whether an error has occurred */ if (TCP_statError()){ ... } /* end if */</pre>

TCP_statPause*Returns the pause status*

Function	Uint32 TCP_statPause();
Arguments	none
Return Value	Status Boolean status
Description	Returns a Boolean status indicating whether the TCP is paused or not.
Example	<pre>/* pause the TCP */ TCP_pause(); /* wait for pause to take place */ while (!TCP_statPause());</pre>

TCP_statRun

TCP_statRun *Returns the run status*

Function	Uint32 TCP_statRun();
Arguments	none
Return Value	Status Boolean status
Description	Returns a Boolean status indicating whether the TCP is running
Example	<pre>/* start the TCP */ TCP_start(); /* check that the TCP is running */ while (!TCP_statRun());</pre>

TCP_statWaitApriori *Returns the apriori data status*

Function	Uint32 TCP_statWaitApriori();
Arguments	none
Return Value	Status Boolean WAP status
Description	Returns the WAP bit status indicating whether the TCP is waiting to receive apriori data.
Example	<pre>/* check if TCP is waiting on apriori data */ if (TCP_statWaitApriori()){ ... } /* end if */</pre>

TCP_statWaitExt *Returns the extrinsics data*

Function	Uint32 TCP_statWaitExt();
Arguments	none
Return Value	Status Boolean REXTstatus
Description	Returns the REXT bit status indicating whether the TCP is waiting for extrinsic data to be read.
Example	<pre>/* check if TCP has extrinsic data pending */ if (TCP_statWaitExt()){ ... } /* end if */</pre>

TCP_statWaitHardDec *Returns the hard decisions data status*

Function	Uint32 TCP_statWaitHardDec();
Arguments	none
Return Value	Status RHD status
Description	Returns the RHD bit status indicating whether the TCP is waiting for the hard decisions data to be read.
Example	<pre>/* check if TCP has hard decisions data pending*/ if (TCP_statWaitHardDec()){ ... } /* end if */</pre>

TCP_statWaitIc *Returns the IC data status*

Function	Uint32 TCP_statWaitIc();
Arguments	none
Return Value	Status WIC status
Description	Returns the WIC bit status indicating whether the TCP is waiting to receive new IC values.
Example	<pre>/* check if TCP is waiting on new IC values */ if (TCP_statWaitIc()){ ... } /* end if */</pre>

TCP_statWaitInter *Returns the interleaver table data status*

Function	Uint32 TCP_statWaitInter();
Arguments	none
Return Value	Status WINT status
Description	Returns the WINT status indicating whether the TCP is waiting to receive interleaver table data.
Example	<pre>/* check if TCP is waiting on interleaver data */ if (TCP_statWaitInter()){ ... } /* end if */</pre>

TCP_statWaitOutParm

TCP_statWaitOutParm *Returns the output parameters data status*

Function Uint32 TCP_statWaitOutParm();

Arguments none

Return Value Status ROP status

Description Returns the ROP bit status indicating whether the TCP is waiting for the output parameters to be read.

Example

```
/* check if TCP has output parameters data pending */
if (TCP_statWaitOutParm()){
    ...
} /* end if */
```

TCP_statWaitSysPar *Returns the systematics and parities data status*

Function Uint32 TCP_statWaitSysPar();

Arguments none

Return Value Status WSP status

Description Returns the WSP bit status indicating whether the TCP is waiting to receive systematic and parity data.

Example

```
/* check if TCP is waiting on systematic and parity
data */
if (TCP_statWaitSysPar()){
    ...
} /* end if */
```

TCP_tailConfig *Generates IC6–IC11 tail values*

Function	<pre>void TCP_tailConfig(TCP_Standard standard, TCP_Mode mode, TCP_Map map, TCP_Rate rate, TCP_UserData *xabData, TCP_ConfigIc *configIc);</pre>												
Arguments	<table border="0"> <tr> <td style="padding-right: 20px;">standard</td> <td>3G standard</td> </tr> <tr> <td>mode</td> <td>Processing mode</td> </tr> <tr> <td>map</td> <td>Map mode for shared processing</td> </tr> <tr> <td>rate</td> <td>Rate</td> </tr> <tr> <td>xabData</td> <td>Pointer to the tail data</td> </tr> <tr> <td>configIc</td> <td>Pointer to the IC values structure</td> </tr> </table>	standard	3G standard	mode	Processing mode	map	Map mode for shared processing	rate	Rate	xabData	Pointer to the tail data	configIc	Pointer to the IC values structure
standard	3G standard												
mode	Processing mode												
map	Map mode for shared processing												
rate	Rate												
xabData	Pointer to the tail data												
configIc	Pointer to the IC values structure												
Return Value	none												
Description	<p>This function generates the input control values IC6–IC11 based on the processing to be performed by the TCP. These values consist of the tail data following the systematics and parities data.</p> <p>This function actually calls specific tail generation functions depending on the standard followed: TCP_tailConfig3GPP or TCP_tailConfigIS2000.</p>												
Example	<pre>extern TCP_Params *configParams; extern TCP_UserData *userData; TCP_ConfigIc *configIC; TCP_Standard standard = configParams->standard; TCP_Mode mode = configParams->mode; TCP_Map map = configParams->map; TCP_Rate rate = configParams->rate; UInt16 index = configParams->frameLen * rate; TCP_UserData *xabData = &userData[index]; ... TCP_setParams(standard, mode, map, rate, xabData, configIc);</pre>												

TCP_tailConfig3GPP *Generates IC6–IC11 tail values for G3PP channels*

Function	<pre>void TCP_tailConfig3GPP(TCP_Mode mode, TCP_Map map, TCP_UserData *xabData, TCP_ConfigIc *configIc);</pre>								
Arguments	<table><tr><td>mode</td><td>Processing mode</td></tr><tr><td>map</td><td>Map mode for shared processing</td></tr><tr><td>xabData</td><td>Pointer to the tail data</td></tr><tr><td>configIc</td><td>Pointer to the IC values structure</td></tr></table>	mode	Processing mode	map	Map mode for shared processing	xabData	Pointer to the tail data	configIc	Pointer to the IC values structure
mode	Processing mode								
map	Map mode for shared processing								
xabData	Pointer to the tail data								
configIc	Pointer to the IC values structure								
Return Value	none								
Description	<p>This function generates the input control values IC6–IC11 for 3GPP channels. These values consist of the tail data following the systematics and parities data. This function is called from the generic TCP_tailConfig function.</p> <p>See also: TCP_tailConfig and TCP_tailConfigIS2000.</p>								
Example	<pre>extern TCP_Params *configParams; extern TCP_UserData *userData; TCP_ConfigIc *configIC; TCP_Mode mode = configParams->mode; TCP_Map map = configParams->map; Uint16 index = configParams->frameLen * rate; TCP_UserData *xabData = &userData[index]; ... TCP_setParams(mode, map, xabData, configIc);</pre>								

TCP_tailConfigIS2000 *Generates IC6–IC11 tail values for IS2000 channels*

Function	Void TCP_tailConfigIS2000(TCP_Mode mode, TCP_Map map, TCP_Rate rate, TCP_UserData *xabData, TCP_ConfigIc *configIc);
Arguments	Mode Processing mode Map Map mode for shared processing Rate Rate XabData Pointer to the tail data configIc Pointer to the IC values structure
Return Value	none
Description	This function generates the input control values IC6 – IC11 for IS2000 channels. These values consist of the tail data following the systematic and parity data. This function is called from the generic TCP_tailConfig function. See also: TCP_tailConfig and TCP_tailConfig3GPP.
Example	extern TCP_Params *configParms; extern TCP_UserData *userData; TCP_ConfigIc *configIC; TCP_Mode mode = configParms->mode; TCP_Map map = configParms->map; TCP_Rate rate = configParms->rate; UInt16 index = configParms->frameLen * rate; TCP_UserData *xabData = &userData[index]; ... TCP_setParams(standard, mode, map, rate, xabData, configIc);

TCP_unpause

TCP_unpause *Unpauses the TCP by writing a '1' to the unpause bit in TCP_EXE*

Function void TCP_unpause();

Arguments none

Return Value none

Description This function un-pauses the TCP by writing a '1' to the UNPAUSE field of the TCP_EXE register. See also `TCP_start()` and `TCP_pause()`.

Example

```
TCP_pause();  
...  
TCP_unpause();
```

TIMER Module

This chapter describes the TIMER module, lists the API functions and macros within the module, discusses how to use a TIMER device, and provides a TIMER API reference section.

Topic	Page
22.1 Overview	22-2
22.2 Macros	22-4
22.3 Configuration Structure	22-6
22.4 Functions	22-7

22.1 Overview

The TIMER module has a simple API for configuring the timer registers.

Table 22–1 lists the configuration structure for use with the TIMER functions. Table 22–2 lists the functions and constants available in the CSL TIMER module.

Table 22–1. TIMER Configuration Structure

Syntax	Type	Description	See page ...
TIMER_Config	S	Structure used to set up a timer device	22-6

Table 22–2. TIMER APIs

(a) Primary Functions

Syntax	Type	Description	See page ...
TIMER_close	F	Closes a previously opened timer device	22-7
TIMER_config	F	Configure timer using configuration structure	22-7
TIMER_configArgs	F	Sets up the timer using the register values passed in	22-8
TIMER_open	F	Opens a TIMER device for use	22-9
TIMER_pause	F	Pauses the timer	22-9
TIMER_reset	F	Resets the timer device associated to the handle	22-10
TIMER_resume	F	Resumes the timer after a pause	22-10
TIMER_start	F	Starts the timer device running	22-10

(b) Auxiliary Functions and Constants

Syntax	Type	Description	See page ...
TIMER_DEVICE_CNT	C	A compile time constant; number of timer devices present	22-11
TIMER_getConfig	F	Reads the current Timer configuration values	22-11
TIMER_getCount	F	Returns the current timer count value	22-11
TIMER_getDatIn	F	Reads the value of the TINP pin	22-12
TIMER_getEventId	F	Obtains the event ID for the timer device	22-12
TIMER_getPeriod	F	Returns the period of the timer device	22-12

Note: F = Function; C = Constant

Syntax	Type	Description	See page ...
TIMER_getTStat	F	Reads the timer status; value of timer output	22-13
TIMER_resetAll	F	Resets all timer devices	22-13
TIMER_setCount	F	Sets the count value of the timer	22-13
TIMER_setDatOut	F	Sets the data output value	22-14
TIMER_setPeriod	F	Sets the timer period	22-14
TIMER_SUPPORT	C	A compile time constant whose value is 1 if the device supports the TIMER module	22-14

Note: F = Function; C = Constant

22.1.1 Using a TIMER Device

To use a TIMER device, you must first open it and obtain a device handle using `TIMER_open()`. Once opened, use the device handle to call the other API functions. The timer device may be configured by passing a `TIMER_Config` structure to `TIMER_config()` or by passing register values to the `TIMER_configArgs()` function. To assist in creating register values, there are `TIMER_RMK` (make) macros that construct register values based on field values. In addition, the symbol constants may be used for the field values.

22.2 Macros

There are two types of TIMER macros: those that access registers and fields, and those that construct register and field values.

Table 22–3 lists the TIMER macros that access registers and fields, and Table 22–4 lists the TIMER macros that construct register and field values. The macros themselves are found in Chapter 28, *Using the HAL Macros*.

The TIMER module includes handle-based macros.

Table 22–3. *TIMER Macros that Access Registers and Fields*

Macro	Description/Purpose	See page ...
TIMER_ADDR(<REG>)	Register address	28-12
TIMER_RGET(<REG>)	Returns the value in the peripheral register	28-18
TIMER_RSET(<REG>,x)	Register set	28-20
TIMER_FGET(<REG>,<FIELD>)	Returns the value of the specified field in the peripheral register	28-13
TIMER_FSET(<REG>,<FIELD>,fieldval)	Writes <i>fieldval</i> to the specified field in the peripheral register	28-15
TIMER_FSETS(<REG>,<FIELD>,<SYM>)	Writes the symbol value to the specified field in the peripheral	28-17
TIMER_RGETA(addr,<REG>)	Gets register for a given address	28-19
TIMER_RSETA(addr,<REG>,x)	Sets register for a given address	28-20
TIMER_FGETA(addr,<REG>,<FIELD>)	Gets field for a given address	28-13
TIMER_FSETA(addr,<REG>,<FIELD>,fieldval)	Sets field for a given address	28-16
TIMER_FSETSAs(addr,<REG>,<FIELD>,<SYM>)	Sets field symbolically for a given address	28-17
TIMER_ADDRH(h,<REG>)	Returns the address of a memory-mapped register for a given handle	28-12
TIMER_RGETH(h,<REG>)	Returns the value of a register for a given handle	28-19
TIMER_RSETH(h,<REG>,x)	Sets the register value to x for a given handle	28-21
TIMER_FGETH(h,<REG>,<FIELD>)	Returns the value of the field for a given handle	28-14
TIMER_FSETH(h,<REG>,<FIELD>,fieldval)	Sets the field value to x for a given handle	28-16

Table 22–4. *TIMER* Macros that Construct Register and Field Values

Macro	Description/Purpose	See page ...
TIMER_<REG>_DEFAULT	Register default value	28-21
TIMER_<REG>_RMK()	Register make	28-23
TIMER_<REG>_OF()	Register value of ...	28-22
TIMER_<REG>_<FIELD>_DEFAULT	Field default value	28-24
TIMER_FMK()	Field make	28-14
TIMER_FMKS()	Field make symbolically	28-15
TIMER_<REG>_<FIELD>_OF()	Field value of ...	28-24
TIMER_<REG>_<FIELD>_<SYM>	Field symbolic value	28-24

TIMER_Config

22.3 Configuration Structure

TIMER_Config *Structure used to setup timer device*

Structure	TIMER_Config
Members	UInt32 ctl Control register value UInt32 prd Period register value UInt32 cnt Count register value
Description	This is the TIMER configuration structure used to set up a timer device. You create and initialize this structure and then pass its address to the <code>TIMER_config()</code> function. You can use literal values or the <code>_RMK</code> macros to create the structure member values.
Example	<pre>TIMER_Config MyConfig = { 0x000002C0, /* ctl */ 0x00010000, /* prd */ 0x00000000 /* cnt */ }; ... TIMER_config(hTimer, &MyConfig);</pre>

22.4 Functions

22.4.1 Primary Functions

TIMER_close	<i>Closes previously opened timer device</i>
Function	void TIMER_close(TIMER_Handle hTimer);
Arguments	hTimer Device handle. See <code>TIMER_open()</code> .
Return Value	none
Description	This function closes a previously opened timer device. See <code>TIMER_open()</code> . The following tasks are performed: <ul style="list-style-type: none"> <input type="checkbox"/> The timer event is disabled and cleared <input type="checkbox"/> The timer registers are set to their default values
Example	<pre>TIMER_close(hTimer);</pre>

TIMER_config	<i>Configure timer using configuration structure</i>
Function	void TIMER_config(TIMER_Handle hTimer, TIMER_Config *config);
Arguments	hTimer Device handle. See <code>TIMER_open()</code> . config Pointer to initialize configuration structure.
Return Value	none
Description	This function sets up the timer device using the configuration structure. The values of the structure are written to the TIMER registers. The timer control register (CTL) is written last. See <code>TIMER_configArgs()</code> and <code>TIMER_Config</code> .
Example	<pre>TIMER_Config MyConfig = { 0x000002C0, /* ctl */ 0x00010000, /* prd */ 0x00000000 /* cnt */ }; ... TIMER_config(hTimer, &MyConfig);</pre>

TIMER_configArgs

TIMER_configArgs Sets up timer using register values passed in

Function	<pre>void TIMER_configArgs(TIMER_Handle hTimer, Uint32 ctl, Uint32 prd, Uint32 cnt);</pre>								
Arguments	<table><tr><td>hTimer</td><td>Device handle. See <code>TIMER_open()</code>.</td></tr><tr><td>ctl</td><td>Control register value</td></tr><tr><td>prd</td><td>Period register value</td></tr><tr><td>cnt</td><td>Count register value</td></tr></table>	hTimer	Device handle. See <code>TIMER_open()</code> .	ctl	Control register value	prd	Period register value	cnt	Count register value
hTimer	Device handle. See <code>TIMER_open()</code> .								
ctl	Control register value								
prd	Period register value								
cnt	Count register value								
Return Value	none								
Description	<p>This function sets up the timer using the register values passed in. The register values are written to the timer registers. The timer control register (<i>ctl</i>) is written last. See also <code>TIMER_config()</code>.</p> <p>You may use literal values for the arguments or for readability. You may use the <i>_RMK</i> macros to create the register values based on field values.</p>								
Example	<pre>TIMER_configArgs (LTimer, 0x000002C0, 0x00010000, 0x00000000);</pre>								

TIMER_open *Opens timer device for use*

Function	TIMER_Handle TIMER_open(int devNum, Uint32 flags);				
Arguments	<table border="0"> <tr> <td style="vertical-align: top;">devNum</td> <td>Device Number: <input type="checkbox"/> TIMER_DEVANY <input type="checkbox"/> TIMER_DEV0 <input type="checkbox"/> TIMER_DEV1 <input type="checkbox"/> TIMER_DEV2</td> </tr> <tr> <td style="vertical-align: top;">flags</td> <td>Open flags, logical OR of any of the following: TIMER_OPEN_RESET</td> </tr> </table>	devNum	Device Number: <input type="checkbox"/> TIMER_DEVANY <input type="checkbox"/> TIMER_DEV0 <input type="checkbox"/> TIMER_DEV1 <input type="checkbox"/> TIMER_DEV2	flags	Open flags, logical OR of any of the following: TIMER_OPEN_RESET
devNum	Device Number: <input type="checkbox"/> TIMER_DEVANY <input type="checkbox"/> TIMER_DEV0 <input type="checkbox"/> TIMER_DEV1 <input type="checkbox"/> TIMER_DEV2				
flags	Open flags, logical OR of any of the following: TIMER_OPEN_RESET				
Return Value	Device Handle Device handle				
Description	<p>Before a TIMER device can be used, it must first be opened by this function. Once opened, it cannot be opened again until closed. See <code>TIMER_close()</code>. The return value is a unique device handle that is used in subsequent TIMER API calls. If the open fails, <code>INV</code> is returned.</p> <p>If the <code>TIMER_OPEN_RESET</code> is specified, the timer device registers are set to their power-on defaults and any associated interrupts are disabled and cleared.</p>				
Example	<pre>TIMER_Handle hTimer; ... hTimer = TIMER_open(TIMER_DEV0, 0);</pre>				

TIMER_pause *Pauses timer*

Function	void TIMER_pause(TIMER_Handle hTimer);
Arguments	hTimer Device handle. See <code>TIMER_open()</code> .
Return Value	none
Description	This function pauses the timer. May be restarted using <code>TIMER_resume()</code> .
Example	<pre>TIMER_pause(hTimer); ... TIMER_resume(hTimer);</pre>

TIMER_reset

TIMER_reset *Resets timer device associated to the Timer handle*

Function	<pre>void TIMER_reset(TIMER_Handle hTimer);</pre>
Arguments	hTimer Device handle. See <code>TIMER_open()</code> .
Return Value	none
Description	This function resets the timer device. Disables and clears the interrupt event and sets the timer registers to default values.
Example	<pre>TIMER_reset(hTimer);</pre>

TIMER_resume *Resumes timer after pause*

Function	<pre>void TIMER_resume(TIMER_Handle hTimer);</pre>
Arguments	hTimer Device handle. See <code>TIMER_open()</code> .
Return Value	none
Description	This function resumes the timer after a pause. See <code>TIMER_pause()</code> .
Example	<pre>TIMER_pause(hTimer); ... TIMER_resume(hTimer);</pre>

TIMER_start *Starts timer device running*

Function	<pre>void TIMER_start(TIMER_Handle hTimer);</pre>
Arguments	hTimer Device handle. See <code>TIMER_open()</code> .
Return Value	none
Description	This function starts the timer device running. HLD of the CTL control register is released and the GO bit field is set.
Example	<pre>TIMER_start(hTimer);</pre>

22.4.2 Auxiliary Functions and Constants

TIMER_DEVICE_CNT *Compile time constant*

Constant	TIMER_DEVICE_CNT
Description	Compile-time constant; number of timer devices present.

TIMER_getConfig *Reads the current TIMER configuration values*

Function	void TIMER_getConfig(TIMER_Handle hTimer, TIMER_Config *config);
Arguments	hTimer Device handle. See <code>TIMER_open()</code> config Pointer to a configuration structure.
Return Value	none
Description	This function reads the TIMER current configuration value
Example	<pre>TIMER_Config timerCfg; TIMER_getConfig(hTimer, &timerCfg);</pre>

TIMER_getCount *Returns current timer count value*

Function	Uint32 TIMER_getCount(TIMER_Handle hTimer);
Arguments	hTimer Device handle. See <code>TIMER_open()</code> .
Return Value	Count Value
Description	This function returns the current timer count value.
Example	<pre>cnt = TIMER_getCount(hTimer);</pre>

TIMER_getDatIn

TIMER_getDatIn *Reads value of TINP pin*

Function	int TIMER_getDatIn(TIMER_Handle hTimer);
Arguments	hTimer Device handle. See <code>TIMER_open()</code> .
Return Value	DATIN Returns DATIN, value on TINP pin; 0 or 1
Description	This function reads the value of the TINP pin.
Example	<pre>tinp = TIMER_getDatIn(hTimer);</pre>

TIMER_getEventId *Obtains event ID for timer device*

Function	Uint32 TIMER_getEventId(TIMER_Handle hTimer);
Arguments	hTimer Device handle. See <code>TIMER_open()</code> .
Return Value	Event ID IRQ Event ID for the timer device
Description	Use this function to obtain the event ID for the timer device.
Example	<pre>TimerEventId = TIMER_getEventId(hTimer); IRQ_enable(TimerEventId);</pre>

TIMER_getPeriod *Returns period of timer device*

Function	Uint32 TIMER_getPeriod(TIMER_Handle hTimer);
Arguments	hTimer Device handle. See <code>TIMER_open()</code> .
Return Value	Period Value Timer period
Description	This function returns the period of the timer device.
Example	<pre>p = TIMER_getPeriod(hTimer);</pre>

TIMER_getTstat *Reads timer status; value of timer output*

Function int TIMER_getTstat(
 TIMER_Handle hTimer
);

Arguments hTimer Device handle. See `TIMER_open()`.

Return Value TSTAT Timer status; 0 or 1

Description This function reads the timer status; value of timer output.

Example status = TIMER_getTstat(hTimer);

TIMER_resetAll *Resets all timer devices supported by the chip device*

Function void TIMER_resetAll();

Arguments none

Return Value none

Description This function resets all timer devices supported by the chip device by clearing and disabling the interrupt event and setting the default timer register values for each timer device. See also `TIMER_reset()` function.

Example `TIMER_resetAll();`

TIMER_setCount *Sets count value of timer*

Function void TIMER_setCount(
 TIMER_Handle hTimer,
 Uint32 count
);

Arguments hTimer Device handle. See `TIMER_open()`.

 count Count value

Return Value none

Description This function sets the count value of the timer. The timer is not paused during the update.

Example `TIMER_setCount(hTimer, 0x00000000);`

TIMER_setDatOut

TIMER_setDatOut *Sets data output value*

Function	<pre>void TIMER_setDatOut(TIMER_Handle hTimer, int val);</pre>				
Arguments	<table><tr><td>hTimer</td><td>Device handle. See <code>TIMER_open()</code>.</td></tr><tr><td>val</td><td>0 or 1</td></tr></table>	hTimer	Device handle. See <code>TIMER_open()</code> .	val	0 or 1
hTimer	Device handle. See <code>TIMER_open()</code> .				
val	0 or 1				
Return Value	none				
Description	This function sets the data output value.				
Example	<pre>TIMER_setDatOut(hTimer, 0);</pre>				

TIMER_setPeriod *Sets timer period*

Function	<pre>void TIMER_setPeriod(TIMER_Handle hTimer, Uint32 period);</pre>				
Arguments	<table><tr><td>hTimer</td><td>Device handle. See <code>TIMER_open()</code>.</td></tr><tr><td>period</td><td>Period value</td></tr></table>	hTimer	Device handle. See <code>TIMER_open()</code> .	period	Period value
hTimer	Device handle. See <code>TIMER_open()</code> .				
period	Period value				
Return Value	none				
Description	This function sets the timer period. The timer is not paused during the update.				
Example	<pre>TIMER_setPeriod(hTimer, 0x00010000);</pre>				

TIMER_SUPPORT *Compile time constant*

Constant	TIMER_SUPPORT
Description	<p>Compile-time constant that has a value of 1 if the device supports the TIMER module and 0 otherwise. You are not required to use this constant.</p> <p>Currently, all devices support this module.</p>
Example	<pre>#if (TIMER_SUPPORT) /* user TIMER configuration / #endif</pre>

UTOPIA Module

This chapter describes the UTOPIA module, lists the API functions and macros within the module, discusses how to set the UTOPIA interface, and provides a UTOP API reference section.

Topic	Page
23.1 Overview	23-2
23.2 Macros	23-4
23.3 Configuration Structure	23-6
23.4 Functions	23-7

23.1 Overview

For TMS320C64x™ devices, the UTOPIA consists of a transmit interface and a receive interface. Both interfaces are configurable via the configuration registers. The properties and functionalities of each interface can be set and controlled by using the CSL APIs dedicated to the UTOPIA interface.

Table 23–1 lists the configuration structure for use with the UTOP functions. Table 23–2 lists the functions and constants available in the CSL UTOPIA module.

Table 23–1. UTOPIA Configuration Structure

Syntax	Type	Description	See page ...
UTOP_Config	S	The UTOPIA configuration structure used to set the control register and the Clock Detect register	23-6

Table 23–2. UTOPIA APIs

Syntax	Type	Description	See page ...
UTOP_config	F	Sets up the UTOPIA interface using the configuration structure	23-7
UTOP_configArgs	F	Sets up the UTOPIA control register and Clock detect register using the register values passed in	23-7
UTOP_enableRcv	F	Enables the receiver interface	23-8
UTOP_enableXmt	F	Enables the transmitter interface	23-8
UTOP_errClear	F	Clears a pending error bit	23-8
UTOP_errDisable	F	Disables an error bit event	23-9
UTOP_errEnable	F	Enables an error bit event	23-9
UTOP_errReset	F	Reset an error bit event by clearing and disabling the corresponding bits under EIPR and EIER respectively.	23-10
UTOP_errTest	F	Tests an error bit event	23-10
UTOP_getConfig	F	Reads the current UTOPIA configuration structure	23-11
UTOP_getEventId	F	Returns the CPU interrupt event number dedicated to the UTOPIA interface	23-11
UTOP_getRcvAddr	F	Returns the Slave Receive Queue Address.	23-11

Table 23–2. UTOPIA APIs (Continued)

Syntax	Type	Description	See page ...
UTOP_getXmtAddr	F	Returns the Slave Transmit Queue Address.	23-12
UTOP_intClear	F	Clears the relevant interrupt pending queue bit of the UTOPIA queue interfaces.	23-12
UTOP_intDisable	F	Disables the relevant interrupt queue bit of the UTOPIA queue interfaces.	23-12
UTOP_intEnable	F	Enables the relevant interrupt queue event of the UTOPIA queue interfaces.	23-13
UTOP_intReset	F	Clears and disables the interrupt queue event of the UTOPIA queue interfaces.	23-13
UTOP_intTest	F	Tests a queue event interrupt	23-14
UTOP_read	F	Reads from the slave receive queue	23-14
UTOP_SUPPORT	C	A compile time constant whose value is 1 if the device supports the UTOPIA module	23-14
UTOP_write	F	Writes into the slave transmit queue	23-15

Note: F = Function; C = Constant

23.1.1 Using UTOPIA APIs

To use the UTOPIA interfaces, you must first configure the Control register and the Clock Detect register by using the configuration structure to `UTOP_config()` or by passing register values to the `UTOP_configArgs()` function. To assist in creating a register value, there is the `UTOP_<REG>_RMK` (make) macro that builds register value based on field values. In addition, the symbol constants may be used for the field setting.

23.2 Macros

There are two types of UTOP macros: those that access registers and fields, and those that construct register and field values.

Table 23–3 lists the UTOP macros that access registers and fields, and Table 23–4 lists the UTOP macros that construct register and field values. The macros themselves are found in Chapter 28, *Using the HAL Macros*.

The UTOPIA module includes handle-based macros.

Table 23–3. UTOP Macros that Access Registers and Fields

Macro	Description/Purpose	See page ...
UTOP_ADDR(<REG>)	Register address	28-12
UTOP_RGET(<REG>)	Returns the value in the peripheral register	28-18
UTOP_RSET(<REG>,x)	Register set	28-20
UTOP_FGET(<REG>,<FIELD>)	Returns the value of the specified field in the peripheral register	28-13
UTOP_FSET(<REG>,<FIELD>,fieldval)	Writes <i>fieldval</i> to the specified field in the peripheral register	28-15
UTOP_FSETS(<REG>,<FIELD>,<SYM>)	Writes the symbol value to the specified field in the peripheral	28-17
UTOP_RGETA(addr,<REG>)	Gets register for a given address	28-19
UTOP_RSETA(addr,<REG>,x)	Sets register for a given address	28-20
UTOP_FGETA(addr,<REG>,<FIELD>)	Gets field for a given address	28-13
UTOP_FSETA(addr,<REG>,<FIELD>,fieldval)	Sets field for a given address	28-16
UTOP_FSETSA(addr,<REG>,<FIELD>,<SYM>)	Sets field symbolically for a given address	28-17

Table 23–4. UTOP Macros that Construct Register and Field Values

Macro	Description/Purpose	See page ...
UTOP_<REG>_DEFAULT	Register default value	28-21
UTOP_<REG>_RMK()	Register make	28-23
UTOP_<REG>_OF()	Register value of ...	28-22
UTOP_<REG>_<FIELD>_DEFAULT	Field default value	28-24
UTOP_FMK()	Field make	28-14
UTOP_FMKS()	Field make symbolically	28-15
UTOP_<REG>_<FIELD>_OF()	Field value of ...	28-24
UTOP_<REG>_<FIELD>_<SYM>	Field symbolic value	28-24

UTOP_Config

23.3 Configuration Structure

UTOP_Config *UTOP configuration structure*

Structure	UTOP_Config
Members	UInt32 ucr UTOP control register value UInt32 cdr UTOP Clock Detect register value
Description	This is the UTOP configuration structure used to set up the UTOPIA registers. You create and initialize this structure then pass its address to the <code>UTOP_config()</code> function. You can use literal values or the <code>_RMK</code> macros to create the structure register value.
Example	<pre>UTOP_Config MyConfig = { 0x00010001, /* ucr */ 0x00FF00FF, /* cdr */ }; ... UTOP_config(MyConfig);</pre>

23.4 Functions

UTOP_config *Sets up UTOP modes using a configuration structure*

Function	void UTOP_config(UTOP_Config *config);
Arguments	config Pointer to an initialized configuration structure
Return Value	none
Description	Sets up the UTOPIA using the configuration structure. The values of the structure are written to the UTOP associated register. See also UTOP_configArgs() and UTOP_Config.
Example	<pre> UTOP_Config MyConfig = { 0x00010000, /* ucr */ 0x00FF00FF, /* cdr */ }; ... UTOP_config(&MyConfig); </pre>

UTOP_configArgs *Sets up UTOP mode using register value passed in*

Function	Void UTOP_configArgs(Uint32 ucr, Uint32 cdr);
Arguments	ucr Control register value cdr Clock Detect value
Return Value	none
Description	<p>Sets up the UTOP mode using the register value passed in. The register value is written to the associated registers. See also UTOP_config().</p> <p>You may use literal values for the arguments or for readability. You may use the <i>_RMK</i> macros to create the register values based on field values.</p>
Example	<pre> UTOP_configArgs(0x00010000, /* ucr */ 0x00FF00FF, /* cdr */); </pre>

UTOP_enableRcv

UTOP_enableRcv *Enables UTOPIA receiver interface*

Function void UTOP_enableRcv();

Arguments none

Return Value none

Description This function enables the UTOPIA receiver port.

Example

```
/* Configures UTOPIA */
UTOP_configArgs(
    0x00040004, /*ucr*/
    0x00FF00FF /*cdr*/
);
/* Enables Receiver port */
UTOP_enableRcv();
```

UTOP_enableXmt *Enables the UTOPIA transmitter interface*

Function void UTOP_enableXmt();

Arguments none

Return Value none

Description This function enables the UTOPIA transmitter port.

Example

```
/* Configures UTOPIA*/
UTOP_configArgs(
    0x00040004, /*ucr*/
    0x00FF00FF /*cdr*/
);
/* Enables Transmitter port */
UTOP_enableXmt();
```

UTOP_errClear *Clears error condition bit*

Function void UTOP_errClear(
 Uint32 errNum
);

Arguments errNum Error condition ID from the following constant list:

- UTOP_ERR_RQS
- UTOP_ERR_RCF
- UTOP_ERR_RCP
- UTOP_ERR_XQS
- UTOP_ERR_XCF
- UTOP_ERR_XCP

Return Value none

Description This function clears the bit of given error condition ID of EIPR.

Example

```
/* Clears bit error condition*/
UTOP_errClear(UTOP_ERR_RCF);
```

UTOP_errDisable *Disables the error interrupt bit*

Function

```
void UTOP_errDisable(
    Uint32 errNum
);
```

Arguments

errNum Error condition ID from the following constant list:

- UTOP_ERR_RQS
- UTOP_ERR_RCF
- UTOP_ERR_RCP
- UTOP_ERR_XQS
- UTOP_ERR_XCF
- UTOP_ERR_XCP

Return Value none

Description This function disables the error interrupt event

Example

```
/* Disables error condition interrupt*/
UTOP_errDisable(UTOP_ERR_RCF);
```

UTOP_errEnable *Enables the error interrupt bit*

Function

```
void UTOP_errEnable(
    Uint32 errNum
);
```

Arguments

errNum Error condition ID from the following constant list:

- UTOP_ERR_RQS
- UTOP_ERR_RCF
- UTOP_ERR_RCP
- UTOP_ERR_XQS
- UTOP_ERR_XCF
- UTOP_ERR_XCP

Return Value none

UTOP_errReset

Description This function enables the error interrupt event.

Example

```
/* Enables error condition interrupt */
UTOP_errEnable(UTOP_ERR_RCF);
```

UTOP_errReset *Resets the error interrupt event bit*

Function

```
void UTOP_errReset(
    Uint32 errNum
);
```

Arguments

errNum Error condition ID from the following constant list:

- UTOP_ERR_RQS
- UTOP_ERR_RCF
- UTOP_ERR_RCP
- UTOP_ERR_XQS
- UTOP_ERR_XCF
- UTOP_ERR_XCP

Return Value none

Description This function resets the error interrupt event by disabling and clearing the error interrupt bit associated to the error condition.

Example

```
/* Resets error condition interrupt */
UTOP_errReset(UTOP_ERR_RCF);
```

UTOP_errTest *Tests the error interrupt event bit*

Function

```
Uint32 UTOP_errTest(
    Uint32 errNum
);
```

Arguments

errNum Error condition ID from the following constant list:

- UTOP_ERR_RQS
- UTOP_ERR_RCF
- UTOP_ERR_RCP
- UTOP_ERR_XQS
- UTOP_ERR_XCF
- UTOP_ERR_XCP

Return Value val Equals to 1 if Error event has occurred and 0 otherwise

Description This function tests the error interrupt event by returning the bit status.

Example

```

/* Enables error condition interrupt */
Uint32 errDetect;
UTOP_errEnable(UTOP_ERR_RCF);
errDetect = UTOP_errTest(UTOP_ERR_RCF)

```

UTOP_getConfig *Reads the current UTOP configuration structure*

Function Uint32 UTOP_getConfig(UTOP_Config *Config);

Arguments Config Pointer to a configuration structure.

Return Value none

Description Get UTOP current configuration value. See also UTOP_config() and UTOP_configArgs() functions.

Example

```

UTOP_config UTOPCfg;

UTOP_getConfig(&UTOPCfg);

```

UTOP_getEventId *Returns the UTOPIA interrupt Event ID*

Function Uint32 UTOP_getEventId();

Arguments none

Return Value val UTOPIA Event ID

Description This function returns the event ID associated to the UTOPIA CPU-interrupt. See also IRQ_EVT_NNNN (IRQ Chapter 13)

Example

```

Uint32 UtopEventId;
UtopEventId = UTOP_getEventId();

```

UTOP_getRcvAddr *Returns the Receiver Queue address*

Function Uint32 UTOP_getRcvAddr();

Arguments none

Return Value val UTOPIA Event ID

UTOP_getXmtAddr

Description This function returns the address of the Receiver Queue. This address is needed when you read from the Receiver Port.

Example

```
Uint32 UtopRcvAddr;  
UtopRcvAddr = UTOP_getRcvAddr();
```

UTOP_getXmtAddr *Returns the Transmit Queue address*

Function Uint32 UTOP_getXmtAddr();

Arguments none

Return Value val UTOPIA Event ID

Description This function returns the address of the Transmit Queue. This address is needed when you write to the Transmit Port.

Example

```
Uint32 UtopXmtAddr;  
UtopXmtAddr = UTOP_getXmtAddr();
```

UTOP_intClear *Clears the interrupt bit related to Receive and Transmit Queues*

Function void UTOP_intClear(
Uint32 intNum
);

Arguments intNum The interrupt ID from the following list:
 UTOP_INT_XQ
 UTOP_INT_RQ

Return Value none

Description Clears the associated bit to the interrupt ID of the utopia interrupt pending register (UIPR) .

Example

```
/* Clears the flag of the receive event */  
UTOP_intClear(UTOP_INT_RQ);
```

UTOP_intDisable *Disables the interrupt to the CPU*

Function void UTOP_intDisable(
Uint32 intNum
);

Arguments intNum The interrupt ID from the following list:
 UTOP_INT_XQ
 UTOP_INT_RQ

Return Value	none
Description	Disables the interrupt bit to the CPU. No interrupts are sent if the corresponding event occurs.
Example	<pre>/* Disables the interrupt of the receive event */ UTOP_intDisable(UTOP_INT_RQ);</pre>

UTOP_intEnable *Enables the interrupt to the CPU*

Function	<pre>void UTOP_intEnable(Uint32 intNum);</pre>
Arguments	intNum The interrupt ID from the following list: <input type="checkbox"/> UTOP_INT_XQ <input type="checkbox"/> UTOP_INT_RQ
Return Value	none
Description	Enables the interrupt to the CPU by setting the bit to 1. The interrupt event is sent to the CPU selector. The CPU interrupt is generated only if the relevant bit is set under UIER register.
Example	<pre>/* Enables the interrupt of the receive event */ UTOP_intEnable(UTOP_INT_RQ); IRQ_enable(IRQ_EVT_UINT);</pre>

UTOP_intReset *Resets the interrupt to the CPU*

Function	<pre>void UTOP_intReset(Uint32 intNum);</pre>
Arguments	intNum The interrupt ID from the following list: <input type="checkbox"/> UTOP_INT_XQ <input type="checkbox"/> UTOP_INT_RQ
Return Value	none
Description	Resets the interrupt to the CPU by disabling the interrupt bit under UIER and clearing the pending bit of UIPR.
Example	<pre>/* Resets the interrupt of the receive event */ UTOP_intReset(UTOP_INT_RQ);</pre>

UTOP_intTest

UTOP_intTest *Tests the interrupt event*

Function	UInt32 UTOP_intReset(UInt32 intNum);
Arguments	intNum The interrupt ID from the following list: <input type="checkbox"/> UTOP_INT_XQ <input type="checkbox"/> UTOP_INT_RQ
Return Value	val Equal to 1 if the event has occurred and 0 otherwise
Description	Tests the interrupt to the CPU has occurred by reading the corresponding flag of UIPR register.
Example	<pre>UInt32 UtopEvent; /* Tests the interrupt of the receive event */ UtopEvent = UTOP_intTest(UTOP_INT_RQ);</pre>

UTOP_read *Reads the UTOPIA receive queue*

Function	UInt32 UTOP_read();
Arguments	none
Return Value	val Value from the receive queue
Description	Reads data from the receive queue.
Example	<pre>UInt32 UtopData; /* Reads data from the receive queue */ UtopData = UTOP_read();</pre>

UTOP_SUPPORT *Compile-time constant*

Constant	UTOP_SUPPORT
Description	Compile-time constant that has a value of 1 if the device supports the UTOP module and 0 otherwise. You are not required to use this constant. Note: The UTOP module is not supported on devices that do not have the UTOP peripheral.
Example	<pre>#if (UTOP_SUPPORT) /* user UTOP configuration */ #endif</pre>

UTOP_write *Writes to the UTOPIA transmit queue*

Function	<code>void UTOP_write(Uint32 val);</code>
Arguments	<code>val</code> Value to be written into transmit queue
Return Value	none
Description	Writes data into the transmit queue.
Example	<pre>Uint32 UtopData = 0x1111FFFF; /* Writes data into the transmit queue */ UTOP_write(UtopData);</pre>

VCP Module

This chapter describes the VCP module, lists the API functions and macros within the module, discusses how to use the VCP, and provides a VCP API reference section.

Topic	Page
24.1 Overview	24-2
24.2 Macros	24-5
24.3 Configuration Structures	24-7
24.4 Functions	24-11

24.1 Overview

The Viterbi co-processor is supported only on TMS320C6416. The VCP should be serviced using the EDMA for most accesses, but the CPU must first configure the VCP control values. There are also a number of functions available to the CPU to monitor the VCP status and access decision and output parameter data.

Table 24–1 lists the configuration structures for use with the VCP functions. Table 24–2 lists the functions and constants available in the CSL VCP module.

Table 24–1. VCP Configuration Structures

Syntax	Type	Description	See page ...
VCP_BaseParams	S	Structure used to set basic VCP Parameters	24-7
VCP_ConfigIc	S	Structure containing the IC register values	24-8
VCP_Params	S	Structure containing all channel characteristics	24-9

Table 24–2. VCP APIs

Syntax	Type	Description	See page ...
VCP_ceil	F	Ceiling function	24-11
VCP_DECISION_HARD	C	Value indicating hard decisions output	24-11
VCP_DECISION_SOFT	C	Value indicating soft decisions output	24-11
VCP_END_NATIVE	C	Value indicating native data format	24-11
VCP_END_PACKED32	C	Value indicating packed data format	24-12
VCP_errTest	F	Returns the error code	24-12
VCP_genIc	F	Generates the VCP_ConfigIc struct based on the VCP parameters provided by the VCP_Params struct	24-12
VCP_genParams	F	Function used to set basic VCP Parameters	24-13
VCP_getBmEndian	F	Returns branch metrics data endian configuration	24-14

Note: F = Function; C = Constant

Table 24–2. VCP APIs (Continued)

Syntax	Type	Description	See page ...
VCP_getIcConfig	F	Returns the IC values already programmed into the VCP	24-14
VCP_getMaxSm	F	Returns the final maximum state metric	24-15
VCP_getMinSm	F	Returns the final minimum state metric	24-15
VCP_getNumInFifo	F	Returns the number of symbols in the input FIFO	24-15
VCP_getNumOutFifo	F	Returns the number of symbols in the output FIFO	24-16
VCP_getSdEndian	F	Returns the soft decisions data configuration	24-16
VCP_getYamBit	F	Returns the Yamamoto bit result	24-16
VCP_icConfig	F	Stores the IC values into the VCP	24-17
VCP_icConfigArgs	F	Stores the IC values into the VCP using arguments	24-18
VCP_normalCeil	F	Normalized ceiling function	24-18
VCP_pause	F	Pauses the VCP	24-19
VCP_RATE_1_2	C	Value indicating a rate of 1/2	24-19
VCP_RATE_1_3	C	Value indicating a rate of 1/3	24-19
VCP_RATE_1_4	C	Value indicating a rate of 1/4	24-19
VCP_reset	F	Resets the VCP	24-19
VCP_setBmEndian	F	Sets the branch metrics data endian configuration	24-20
VCP_setNativeEndian	F	Sets all data formats to be native (not packed data)	24-20
VCP_setPacked32Endian	F	Sets all data formats to be packed data	24-21
VCP_setSdEndian	F	Sets the soft decisions data configuration	24-21
VCP_start	F	Starts the VCP	24-21
VCP_statError	F	Returns the error status	24-22
VCP_statInFifo	F	Returns the input FIFO status	24-22

Note: F = Function; C = Constant

Table 24–2. VCP APIs (Continued)

Syntax	Type	Description	See page ...
VCP_statOutFifo	F	Returns the output FIFO status	24-22
VCP_statPause	F	Returns the pause status	24-23
VCP_statRun	F	Returns the run status	24-23
VCP_statSymProc	F	Returns the Number of Symbols processed status bit	24-23
VCP_statWaitlc	F	Returns the input control status	24-24
VCP_stop	F	Stops the VCP	24-24
VCP_TRACEBACK_CONVERGENT	C	Value indicating convergent traceback mode	24-24
VCP_TRACEBACK_MIXED	C	Value indicating mixed traceback mode	24-24
VCP_TRACEBACK_TAILED	C	Value indicating tailed traceback mode	24-25
VCP_unpause	F	Unpauses the VCP	24-25

Note: F = Function; C = Constant

24.1.1 Using the VCP

To use the VCP, you must first configure the control values, or IC values, that will be sent via the EDMA to program its operation. To do this, the `VCP_Params` structure is passed to `VCP_icConfig()`. `VCP_Params` contains all of the channel characteristics required to configure the VCP. This configuration function returns a pointer to the IC values that are to be sent using the EDMA. If desired, the configuration function can be bypassed and the user can generate each IC value independently using several `VCP_RMK` (make) macros that construct register values based on field values. In addition, the symbol constants may be used for the field values.

When operating in big endian mode the CPU must configure the format of all the data to be transferred to and from the VCP. This is accomplished by programming the VCP Endian register (`VCP_END`). Typically, the data will all be of the same format, either following the native element size (either 8-bit or 16-bit) or packed into a 32-bit word. This being the case, the values can be set using a single function call to either `VCP_nativeEndianSet()` or `VCP_packed32EndianSet()`. Alternatively, the data format of individual data types can be programmed with independent functions.

The user can monitor the status of the VCP during operation and also monitor error flags if there is a problem.

24.2 Macros

There are two types of VCP macros: those that access registers and fields, and those that construct register and field values. These are not required as all VCP configuring and monitoring can be done through the provided functions. These VCP functions make use of a number of macros.

Table 24–3 lists the VCP macros that access registers and fields, and Table 24–4 lists the VCP macros that construct register and field values. The macros themselves are found in Chapter 28, *Using the HAL Macros*.

The VCP module includes handle-based macros.

Table 24–3. VCP Macros that Access Registers and Fields

Macro	Description/Purpose	See page ...
VCP_ADDR(<REG>)	Register address	28-12
VCP_RGET(<REG>)	Returns the value in the peripheral register	28-18
VCP_RSET(<REG>,x)	Register set	28-20
VCP_FGET(<REG>,<FIELD>)	Returns the value of the specified field in the peripheral register	28-13
VCP_FSET(<REG>,<FIELD>,fieldval)	Writes <i>fieldval</i> to the specified field in the peripheral register	28-15
VCP_FSETS(<REG>,<FIELD>,<SYM>)	Writes the symbol value to the specified field in the peripheral	28-17
VCP_RGETA(addr,<REG>)	Gets register for a given address	28-19
VCP_RSETA(addr,<REG>,x)	Sets register for a given address	28-20
VCP_FGETA(addr,<REG>,<FIELD>)	Gets field for a given address	28-13
VCP_FSETA(addr,<REG>,<FIELD>,fieldval)	Sets field for a given address	28-16
VCP_FSETSA(addr,<REG>,<FIELD>,<SYM>)	Sets field symbolically for a given address	28-17

Table 24–4. VCP Macros that Construct Register and Field Values

Macro	Description/Purpose	See page ...
VCP_<REG>_DEFAULT	Register default value	28-21
VCP_<REG>_RMK()	Register make	28-23
VCP_<REG>_OF()	Register value of ...	28-22
VCP_<REG>_<FIELD>_DEFAULT	Field default value	28-24
VCP_FMK()	Field make	28-14
VCP_FMKS()	Field make symbolically	28-15
VCP_<REG>_<FIELD>_OF()	Field value of ...	28-24
VCP_<REG>_<FIELD>_<SYM>	Field symbolic value	28-24

24.3 Configuration Structure

VCP_BaseParams *Structure used to set basic TCP parameters*

Structure VCP_BaseParams

Members

VCP_Rate	rate;	Code rate
Uint8	constLen;	Code rate
Uint16	frameLen;	Frame Length
Uint16	yamTh;	Yamamoto Threshold
Uint8	stateNum;	State Index
Uint8	decision;	Hard/soft Decision
Uint8	readFlag;	Output Parameter Read flag

Description This is the VCP base parameters structure used to set up the VCP programmable parameters. You create the object and pass it to the VCP_genParams() function which returns the VCP_Params structure. See the VCP_genParams() function.

Example

```
VCP_BaseParams vcpBaseParam0 = {
    3,      /* Rate */
    9,      /*Constraint Length (K=5,6,7,8, OR 9)*/
    81,     /*Frame Length (FL) */
    0,      /*Yamamoto Threshold (YAMT)*/
    0,      /*Stat Index to set to IMAXS (IMAXI) */
    0,      /*Output Hard Decision Type */
    0      /*Output Parameters Read Flag */
};
...
VCP_genParams (&vcpBaseParam0, &vcpParam0);
```

VCP_ConfigIc

VCP_ConfigIc

Structure containing the IC register values

Structure	<pre>typedef struct { Uint32 ic0; Uint32 ic1; Uint32 ic2; Uint32 ic3; Uint32 ic4; Uint32 ic5; } VCP_ConfigIc;</pre>
Members	<pre>ic0 Input Configuration word 0 value ic1 Input Configuration word 1 value ic2 Input Configuration word 2 value ic3 Input Configuration word 3 value ic4 Input Configuration word 4 value ic5 Input Configuration word 5 value</pre>
Description	<p>This is the VCP input configuration structure that holds all of the configuration values that are to be transferred to the VCP via the EDMA. Though using the EDMA is highly recommended, the values can be written to the VCP using the CPU with the <code>VCP_icConfig()</code> function.</p>
Example	<pre>extern VCP_Params *params; VCP_ConfigIc *config; ... VCP_genIc(params, config);</pre>

VCP_Params*Structure containing all channel characteristics***Structure**

```

typedef struct {
    VCP_Rate    rate;
    Uint32     constLen;
    Uint32     poly0;
    Uint32     poly1;
    Uint32     poly2;
    Uint32     poly3;
    Uint32     yamTh;
    Uint32     frameLen;
    Uint32     relLen;
    Uint32     convDist;
    Uint32     maxSm;
    Uint32     minSm;
    Uint32     stateNum;
    Uint32     bmBuffLen;
    Uint32     decBuffLen;
    Uint32     traceBack;
    Uint32     readFlag;
    Uint32     decision;
    Uint32     numBranchMetrics;
    Uint32     numDecisions;
} VCP_Params;

```

Members

rate	The rate: 1/2, 1/3, 1/4 The available constants are: <input type="checkbox"/> VCP_RATE_1_2 <input type="checkbox"/> VCP_RATE_1_3 <input type="checkbox"/> VCP_RATE_1_4
constLen	Constraint length
poly0	Polynomial 0
poly1	Polynomial 1
poly2	Polynomial 2
poly3	Polynomial 3
yamTh	Yamamoto Threshold value
frameLen	The number of symbols in a frame
relLen	Reliability length
convDist	Convergence distance
maxSm	Maximum initial state metric
minSm	Minimum initial state metric
stateNum	State index set to the maximum initial state metric

VCP_Params

bmBuffLen	Branch metrics buffer length in input FIFO
decBuffLen	Decisions buffer length in output FIFO
traceBack	Traceback mode The available constants are: <input type="checkbox"/> VCP_TRACEBACK_NONE <input type="checkbox"/> VCP_TRACEBACK_TAILED <input type="checkbox"/> VCP_TRACEBACK_MIXED <input type="checkbox"/> VCP_TRACEBACK_CONVERGENT
readFlag	Output parameters read flag
decision	Decision selection: hard or soft The following constants are available: <input type="checkbox"/> VCP_DECISION_HARD <input type="checkbox"/> VCP_DECISION_SOFT
numBranchMetrics	Number of branch metrics per event
numDecisions	Number of decisions words per event

Description

This is the VCP parameters structure that holds all of the information concerning the user channel. These values are used to generate the appropriate input configuration values for the VCP and to program the EDMA.

Example

```
extern VCP_Params *params;
VCP_ConfigIc *config;
...
VCP_genIc(params, config);
...
```

24.4 Functions

VCP_ceil *Ceiling function*

Function	Uint32 VCP_ceil(Uint32 val, Uint32 pwr2);	
Arguments	val	Value to be augmented
	pwr2	The power of two by which val must be divisible
Return Value	ceilVal	The smallest number which when multiplied by 2^{pwr2} is greater than val.
Description	This function calculates the ceiling for a given value and a power of 2. The arguments follow the formula: $\text{ceilVal} * 2^{\text{pwr2}} = \text{ceiling}(\text{val}, \text{pwr2})$.	
Example	<pre>numSysPar = VCP_ceil((frameLen * rate), 4);</pre>	

VCP_DECISION_HARD *Value indicating hard decisions output*

Constant	VCP_DECISION_HARD
Description	This constant allows selection of hard decisions output from the VCP.

VCP_DECISION_SOFT *Value indicating soft decisions output*

Constant	VCP_DECISION_SOFT
Description	This constant allows selection of soft decisions output from the VCP.

VCP_END_NATIVE *Value indicating native endian format*

Constant	VCP_END_NATIVE
Description	This constant allows selection of the native format for all data transferred to and from the VCP. That is to say that all data is contiguous in memory with incrementing addresses.

VCP_END_PACKED32

VCP_END_PACKED32 *Value indicating little endian format within packed 32-bit words*

Constant VCP_END_PACKED32

Description This constant allows selection of the packed 32-bit format for data transferred to and from the VCP. That is to say that all data is packed into 32-bit words in little endian format and these words are contiguous in memory.

VCP_errTest *Returns the error code*

Function Uint32 VCP_errTest();

Arguments None

Return Value Error code Code error value

Description This function returns an ERR bit indicating what VCP error has occurred.

Example

```
/* check whether an error has occurred */
if (VCP_errTest()){
} /* end if */
```

VCP_genIc *Generates the VCP_ConfigIc struct*

Function void VCP_genIc(
 VCP_Params *restrict configParms,
 VCP_ConfigIc *restrict configIc
)

Arguments configParms Pointer to Channel parameters structure
configIc Pointer to Input Configuration structure

Return Value None

Description This function generates the required input configuration values needed to program the VCP based on the parameters provided by configParms.

Example

```
extern VCP_Params *params;
VCP_ConfigIc *config;
...
VCP_genIc(params, config);

...
```

VCP_genParams *Sets basic VCP Parameters*

Function	<pre>void VCP_genParams(VCP_BaseParams *configBase, VCP_Params *configParams)</pre>
Arguments	configBase Pointer to VCP_BaseParams structure configParams Output VCP_Params structure pointer
Return Value	None
Description	This function calculates the TCP parameters based on the input VCP_BaseParams object values and set the values to the output VCP_Params parameters structure.

The calculated parameters are:

Polynomial constants:

- G0-G3 (POLY1-POLY3)
- Traceback (TB)
- Convergence Distance (CD)
- Reliability Length (R)
- Decision Buffer Length (SYMR +1)
- Branch Metric Buffer Length (SYMX +1)
- Max Initial Metric State (IMAXS)
- Min Initial Metric State (IMINS)

Example

```
VCP_Params vcpParam0;  
VCP_genParams (&vcpBaseParam0, &vcpParam0);
```

VCP_getBmEndian

VCP_getBmEndian *Returns branch metrics data endian configuration*

Function Uint32 VCP_getBmEndian();

Arguments None

Return Value Endian Endian setting for branch metrics data

Description This function returns the value programmed into the END register for the branch metrics data indicating whether the data is in its native 8-bit format ('1') or consists of values packed in little endian format into 32-bit words ('0'). This should always be '0' for little endian operation.

See also VCP_setBmEndian, VCP_setNativeEndian, VCP_setPacked32Endian, VCP_getSdEndian, VCP_setSdEndian.

Example

```
If (VCP_getBmEndian()){  
    ...  
} /* end if */
```

VCP_getIcConfig *Returns the IC values already programmed into the VCP*

Function void VCP_getIcConfig(VCP_ConfigIc *config)

Arguments config Pointer to Input Configuration structure

Return Value None

Description This function reads the input configuration values currently programmed into the VCP.

Example

```
VCP_ConfigIc *config;  
...  
VCP_getIcConfig(config);  
  
...
```

VCP_getMaxSm *Returns the final maximum state metric*

Function	Uint32 VCP_getMaxSm();
Arguments	None
Return Value	State Metric Final maximum state metric
Description	<p>This function returns the final maximum state metric after the VCP has completed its decoding.</p> <p>See also VCP_getMinSm.</p>
Example	<pre>Uint32 maxSm; MaxSm = VCP_getMaxSm();</pre>

VCP_getMinSm *Returns the final minimum state metric*

Function	Uint32 VCP_getMinSm();
Arguments	None
Return Value	State Metric Final minimum state metric
Description	<p>This function returns the final minimum state metric after the VCP has completed its decoding.</p> <p>See also VCP_getMaxSm.</p>
Example	<pre>Uint32 minSm; MinSm = VCP_getMinSm();</pre>

VCP_getNumInFifo *Returns the number of symbols in the input FIFO*

Function	Uint32 VCP_getNumInFifo();
Arguments	None
Return Value	count The number of symbols currently in the input FIFO
Description	this function returns the number of symbols currently in the input FIFO.
Example	<pre>numSym = VCP_getNumInFifo();</pre>

VCP_getNumOutFifo

VCP_getNumOutFifo *Returns the number of symbols in the output FIFO*

Function `Uint32 VCP_getNumOutFifo();`

Arguments None

Return Value `count` The number of symbols currently in the output FIFO

Description this function returns the number of symbols currently in the output FIFO.

Example `numSym = VCP_getNumOutFifo();`

VCP_getSdEndian *Returns soft decision data endian configuration*

Function `Uint32 VCP_getSdEndian();`

Arguments None

Return Value `Endian` Endian setting for soft decision data

Description This function returns the value programmed into the VCP_END register for the soft decision data indicating whether the data is in its native 16-bit format ('1') or consists of values packed in little endian format into 32-bit words ('0'). This should always be '0' for little endian operation.

See also `VCP_setSdEndian`, `VCP_setNativeEndian`, `VCP_setPacked32Endian`.

Example

```
If (VCP_getBmEndian()){
    ...
} /* end if */
```

VCP_getYamBit *Returns the Yamamoto bit result*

Function `Uint32 VCP_getYamBit();`

Arguments None

Return Value `bit` Yamamoto bit result

Description Returns the value of the Yamamoto bit after the VCP decoding.

Example

```
Uint32 yamBit;
YamBit = VCP_getYamBit();
```

VCP_icConfig *Stores the IC values into the VCP*

Function void VCP_icConfig(VCP_ConfigIc *config)

Arguments Config Pointer to Input Configuration structure

Return Value None

Description This function stores the input configuration values currently programmed into the VCP. This is not the recommended means by which to program the VCP, as it is more efficient to transfer the IC values using the EDMA, but can be used in test code.

Example

```
extern VCP_Params *params;
VCP_ConfigIc *config;
...
VCP_genIc(params, config);
VCP_icConfig(config);
...
```

VCP_icConfigArgs

VCP_icConfigArgs *Stores the IC values into the VCP using arguments*

Function	<pre>void VCP_icConfigArgs(Uint32 ic0, Uint32 ic1, Uint32 ic2, Uint32 ic3, Uint32 ic4, Uint32 ic5)</pre>
Arguments	<pre>ic0 Input Configuration word 0 value ic1 Input Configuration word 1 value ic2 Input Configuration word 2 value ic3 Input Configuration word 3 value ic4 Input Configuration word 4 value ic5 Input Configuration word 5 value</pre>
Return Value	None
Description	This function stores the input configuration values currently programmed into the VCP. This is not the recommended means by which to program the VCP, as it is more efficient to transfer the IC values using the EDMA, but can be used in test code.
Example	<pre>VCP_icConfigArgs (0x00283200 /* IC0 */ 0x00270000 /* IC1 */ 0x00080118 /* IC2 */ 0x001E0014 /* IC3 */ 0x00000000 /* IC4 */ 0x00000002 /* IC5 */);</pre>

VCP_normalCeil *Normalized ceiling function*

Function	<pre>Uint32 VCP_normalCeil(Uint32 val1, Uint32 val2) ;</pre>
Arguments	<pre>val1 Value to be augmented val2 Value by which val1 must be divisible</pre>
Return Value	<pre>ceilVal The smallest number greater than or equal to val1 that is divisible by val2.</pre>
Description	This function returns the smallest number greater than or equal to val1 that is divisible by val2.
Example	<pre>winSize = VCP_normalCeil(winSize, numSlidingWindow);</pre>

VCP_pause *Pauses VCP by writing a pause command in VCP_EXE*

Function	void VCP_pause();
Arguments	None
Return Value	None
Description	This function pauses the VCP by writing a pause command in the VCP_EXE register. See also VCP_start(), VCP_unpause(), and VCP_stop().
Example	VCP_pause();

VCP_RATE_1_2 *Value indicating a rate of 1/2*

Constant	VCP_RATE_1_2
Description	This constant allows selection of a rate of 1/2.

VCP_RATE_1_3 *Value indicating a rate of 1/3*

Constant	VCP_RATE_1_3
Description	This constant allows selection of a rate of 1/3.

VCP_RATE_1_4 *Value indicating a rate of 1/4*

Constant	VCP_RATE_1_4
Description	This constant allows selection of a rate of 1/4.

VCP_reset *Resets VCP registers to default values*

Function	Uint32 VCP_reset();
Arguments	None
Return Value	None
Description	This function sets all of the VCP control registers to their default values.
Example	VCP_reset();

VCP_setBmEndian

VCP_setBmEndian *Sets the branch metrics data endian configuration*

Function	Void VCP_setBmEndian(Uint32 bmEnd);
Arguments	bmEnd Endian setting for branch metrics data The following constants can be used: <input type="checkbox"/> VCP_END_NATIVE <input type="checkbox"/> VCP_END_PACKED32
Return Value	None
Description	This function programs the VCP to view the format of the branch metrics data as either native 8-bit format ('1') or values packed into 32-bit words in little endian format ('0'). This should always be '0' for little endian operation. See also VCP_getBmEndian, VCP_setNativeEndian, VCP_setPacked32Endian.
Example	<pre>VCP_setBmEndian(VCP_END_PACKED32);</pre>

VCP_setNativeEndian *Sets all data formats to native (not packed data)*

Function	void VCP_setNativeEndian();
Arguments	None
Return Value	None
Description	This function programs the VCP to view the format of all data as native 8-/16-bit format. This should only be used when running in big endian mode. See also VCP_setPacked32Endian, VCP_getBmEndian, VCP_getSdEndian, VCP_setBmEndian, VCP_setSdEndian.
Example	<pre>VCP_setNativeEndian();</pre>

VCP_setPacked32Endian *Sets all data formats to packed data*

Function	<code>void VCP_setPacked32Endian();</code>
Arguments	None
Return Value	None
Description	<p>This function programs the VCP to view the format of all data as packed data in 32-bit words. This should always be used when running in little endian mode and should be used in big endian mode only if the CPU is formatting the data.</p> <p>See also <code>VCP_setNativeEndian</code>, <code>VCP_getBmEndian</code>, <code>VCP_getSdEndian</code>, <code>VCP_setBmEndian</code>, <code>VCP_setSdEndian</code>.</p>
Example	<code>VCP_setPacked32Endian();</code>

VCP_setSdEndian *Sets soft decision data endian configuration*

Function	<code>Void VCP_setSdEndian (Uint32 sdEnd);</code>
Arguments	<p>SdEnd Endian setting for soft decision data The following constants can be used:</p> <ul style="list-style-type: none"><input type="checkbox"/> <code>VCP_END_NATIVE</code><input type="checkbox"/> <code>VCP_END_PACKED32</code>
Return Value	None
Description	<p>This function programs the VCP to view the format of the soft decision data as either native 8-bit format ('1') or values packed into 32-bit words in little endian format ('0'). This should always be '0' for little endian operation.</p> <p>See also <code>VCP_getSdEndian</code>, <code>VCP_setNativeEndian</code>, <code>VCP_setPacked32Endian</code>.</p>
Example	<code>VCP_setSdEndian(VCP_END_PACKED32);</code>

VCP_start *Starts VCP by writing a start command in VCP_EXE*

Function	<code>void VCP_start();</code>
Arguments	None
Return Value	None
Description	<p>This function starts the VCP by writing a start command to the VCP_EXE register. See also <code>VCP_pause()</code>, <code>VCP_unpause()</code>, and <code>VCP_stop()</code>.</p>
Example	<code>VCP_start();</code>

VCP_statError

VCP_statError *Returns the error status*

Function	Uint32 VCP_statError();
Arguments	None
Return Value	Error status Boolean indication of any error
Description	This function returns a Boolean value indicating whether any VCP error has occurred.
Example	<pre>/* check whether an error has occurred */ if (VCP_statError()){ error = VCP_errTest(); } /* end if */</pre>

VCP_statInFifo *Returns the input FIFO status*

Function	Uint32 VCP_statInFifo();
Arguments	None
Return Value	Empty Flag Flag indicating FIFO empty
Description	This function returns the input FIFO's empty status flag. A '1' indicates that the input FIFO is empty and a '0' indicates it is not empty.
Example	<pre>If (VCP_statInFifo()){ ... } /* end if */</pre>

VCP_statOutFifo *Returns the output FIFO status*

Function	Uint32 VCP_statOutFifo();
Arguments	None
Return Value	Empty Flag Flag indicating FIFO full
Description	This function returns the output FIFO's full status flag. A '1' indicates that the output FIFO is full and a '0' indicates it is not full.
Example	<pre>If (VCP_statOutFifo()){ ... } /* end if */</pre>

VCP_statPause *Returns pause status*

Function	Uint32 VCP_statPause();
Arguments	None
Return Value	Status Boolean status
Description	This function returns the PAUSE bit status indicating whether the VCP is paused or not.
Example	<pre>/* pause the VCP */ VCP_pause(); /* wait for pause to take place */ while (!VCP_statPause());</pre>

VCP_statRun *Returns the run status*

Function	Uint32 VCP_statRun();
Arguments	None
Return Value	Status Boolean status
Description	This function returns the RUN bit status indicating whether the VCP is running.
Example	<pre>/* start the VCP */ VCP_start(); /* check that the VCP is running */ while (!VCP_statRun());</pre>

VCP_statSymProc *Returns number of symbols processed*

Function	Uint32 VCP_statSymProc();
Arguments	None
Return Value	count The number of symbols processed
Description	This function returns the NSYMPROC status bit of the VCP.
Example	<pre>numSym = VCP_statSymProc();</pre>

VCP_statWaitIc

VCP_statWaitIc *Returns input control status*

Function	Uint32 VCP_statWaitIc();
Arguments	None
Return Value	Status Boolean status
Description	This function returns the WIC bit status indicating whether the VCP is waiting to receive new IC values.
Example	<pre>If (statWaitIc()){ ... } /* end if */</pre>

VCP_stop *Stops the VCP by writing a stop command in VCP_EXE*

Function	void VCP_stop();
Arguments	None
Return Value	None
Description	This function stops the VCP by writing a stop command to the VCP_EXE register. See also <code>VCP_pause()</code> , <code>VCP_unpause()</code> , and <code>VCP_start()</code> .
Example	<pre>VCP_stop();</pre>

VCP_TRACEBACK_CONVERGENT *Value indicating convergent traceback mode*

Constant	VCP_TRACEBACK_CONVERGENT
Description	This constant allows selection of convergent traceback mode.

VCP_TRACEBACK_MIXED *Value indicating mixed traceback mode*

Constant	VCP_TRACEBACK_MIXED
Description	This constant allows selection of mixed traceback mode.

VCP_TRACEBACK_TAILED *Value indicating tailed traceback mode*

Constant VCP_TRACEBACK_TAILED
Description This constant allows selection of tailed traceback mode.

VCP_unpause *Un-pauses the VCP by writing an unpause command in VCP_EXE*

Function void VCP_unpause();
Arguments None
Return Value None
Description This function un-pauses the VCP by writing an un-pause command to the VCP_EXE register. See also VCP_pause(), VCP_start(), and VCP_stop().
Example VCP_unpause();

VIC Module

Describes the VIC module, lists the API functions and macros within the module, and provides a VIC reference section.

Topic	Page
25.1 Overview	25-2
25.2 Macros	25-3
25.3 Functions	25-4

25.1 Overview

The VCXO interpolated control (VIC) port provides single-bit interpolated VCXO control with resolution from 9 bits to up to 16 bits. The frequency of interpolation is dependent on the resolution needed. The VIC module is currently supported only on the DM642, DM641, and DM640 devices.

Table 25–1 lists the functions and constants available in the CSL VIC module.

Table 25–1. VIC Functions and Constants

Syntax	Type	Description	See page
VIC_getPrecision	F	Gets the resolution of the interpolation	25-4
VIC_getGo	F	Gets the value of the GO bit of the VICCTL register	25-4
VIC_getInputBits	F	Gets the value written by the DSP	25-5
VIC_getClkDivider	F	Gets the clock divider for the interpolation frequency	25-5
VIC_setPrecision	F	Sets the resolution of the interpolation	25-6
VIC_setGo	F	Sets the value of the GO bit of the VICCTL register	25-6
VIC_setInputBits	F	Writes to the VICIN register	25-7
VIC_setClkDivider	F	Sets the clock divider for the interpolation frequency	25-7

25.2 Macros

There are two types of VIC macros: those that access registers and fields, and those that construct register and field values. Table 25–2 lists the VIC macros that access registers and fields, and Table 25–3 lists the VIC macros that construct register and field values. The macros themselves are found in Chapter 28, *Using the HAL Macros*.

Table 25–2. VIC Macros That Access Registers and Fields

Macro	Description/Purpose	See page
VIC_ADDR(<REG>)	Register address	28-12
VIC_RGET(<REG>)	Returns the value in the peripheral register	28-18
VIC_RSET(<REG>,x)	Returns the value of the specified field in the peripheral register	28-20
VIC_FGET(<REG>,<FIELD>)	Register set	28-13
VIC_FSET(<REG>,<FIELD>,fieldval)	Writes fieldval to the specified field in the peripheral register	28-15
VIC_FSETS(<REG>,<FIELD>,<SYM>)	Writes the symbol value to the specified field in the peripheral	28-17
VIC_RGETA(addr,<REG>)	Gets register for a given address	28-19
VIC_RSETA(addr,<REG>,x)	Sets register for a given address	28-20
VIC_FGETA(addr,<REG>,<FIELD>)	Gets field for a given address	28-13
VIC_FSETA(addr,<REG>,<FIELD>, fieldval)	Sets field for a given address	28-16
VIC_FSETSA(addr,<REG>,<FIELD>, <SYM>)	Sets field symbolically for a given address	28-17

Table 25–3. VIC Macros That Construct Register and Field Values

Macro	Description/Purpose	See page
VIC_<REG>_DEFAULT	Register default value	28-21
VIC_<REG>_RMK()	Register make	28-23
VIC_<REG>_OF()	Register value of ...	28-22
VIC_<REG>_<FIELD>_DEFAULT	Field default value	28-24
VIC_FMK()	Field make	28-14
VIC_FMKS()	Field make symbolically	28-15
VIC_<REG>_<FIELD>_OF()	Field value of ...	28-24
VIC_<REG>_<FIELD>_<SYM>	Field symbolic value	28-24

VIC_getPrecision

25.3 Functions

VIC_getPrecision *Gets the value of the precision bits*

Function	Uint32 VIC_getPrecision();
Arguments	None
Return Value	Uint32 Returns the precision of resolution of the interpolation
Description	Precision bits determine the resolution of the interpolation.
Example	<pre>Uint32 precision; ... precision = VIC_getPrecision();</pre>

VIC_getGo *Gets the value of the GO bit of the VICCTL register*

Function	Uint32 VIC_getGo();
Arguments	None
Return Value	Uint32 Returns precision of resolution of the interpolation
Description	Gets the status of the GO bit. If this is 0, writes to the VICCTL and VICDIV registers are permitted. A GO bit value of 1 disallows writes to these registers.
Example	<pre>Uint32 getGoStatus; ... getGoStatus = VIC_getGo();</pre>

VIC_getInputBits *Gets the value written by the DSP*

Function	Uint32 VIC_getInputBits
Arguments	None
Return Value	Uint32 Returns value written by DSP to the VICIN register
Description	<p>The DSP writes the input bits for VCXO interpolated control in the VIC input register (VICIN). The DSP can write to VICIN only when the GO bit in the VIC control register (VICCTL) is set to 1.</p> <p>This API returns the value written by the DSP to the VICINBITS field of the VICIN register.</p>

Example

```
Uint32 getInputBits;
...
getInputBits = VIC_getInputBits();
```

VIC_getClkDivider *Gets the clock divider for the interpolation frequency*

Function	Uint32 VIC_getClkDivider
Arguments	None
Return Value	Uint32 Returns value of the VICCLKDIV field of the VICDIV register
Description	<p>The VIC clock divider register (VICDIV) defines the clock divider for the VIC interpolation frequency. This API returns this value.</p>

Example

```
Uint32 getClkDivider;
...
getClkDivider = VIC_getClkDivider();
```

VIC_setPrecision

VIC_setPrecision *Sets the resolution of the interpolation*

Function	void VIC_setPrecision
Arguments	Uint32 Precision value
Return Value	None
Description	Precision bits determine the resolution of the interpolation. The PRECISION bits can only be written when the GO bit is cleared to 0. If the GO bit is set to 1, a write to the PRECISION bits does not change the bits.
Example	<pre>VIC_setPrecision(VIC_VICCTL_PRECISION_16BITS);</pre>

VIC_setGo *Sets the value of the GO bit of the VICCTL register*

Function	void VIC_setGo
Arguments	Uint32 Value
Return Value	None
Description	<p>The GO bit can be written to at any time. This bit controls whether writes to VICDIV and VICCTL registers are permitted or are invalid. If the GO bit is 0, these registers can be updated. A write to VICCTL programs the VICCTL register and sets the GO bit to 1, disallowing any further changes to the VICCTL and VICDIV registers.</p> <p>If the GO bit is 1, the VICDIV and VICCTL (except for the GO bit) registers cannot be written. If a write is performed to the VICDIV or VICCTL registers when the GO bit is set, the values of these registers remain unchanged. If a write is performed that clears the GO bit to 0 and changes the values of other VICCTL bits, it results in GO = 0 while keeping the rest of the VICCTL bits unchanged. The VIC port is in its normal working mode in this state.</p>
Example	<pre>VIC_setGo(VIC_VICCTL_GO_0);</pre>

VIC_setInputBits *Writes to the VICIN register*

Function	VIC_setInputBits
Arguments	Uint32 Value
Return Value	None
Description	Sets the given value to the VICINBITS of the VICIN register
Example	<code>VIC_setInputBits(0x00000001);</code>

VIC_setClkDivider *Sets the clock divider for the interpolation frequency*

Function	VIC_setClkDivider
Arguments	Uint32 Value
Return Value	None
Description	Sets the value of the clock divider for the interpolation frequency
Example	<code>VIC_setClkDivider(0x00000001);</code>

VP Module

This chapter describes the VP module, lists the API functions and macros within the module, and provides a VP reference section.

Topic	Page
26.1 Overview	26-2
26.2 Configuration Structures	26-4
26.3 Functions and Constants	26-9

26.1 Overview

The video port peripheral can operate as a video capture port, video display port, or transport stream interface (TSI) capture port. For more information about the peripheral, refer to the TMS320C64x DSP Video Port Reference Guide (SPRU629).

Table 26–1 lists the configuration structures available in the CSL VP module.

Table 26–2 lists the functions and constants available in the CSL VP module.

Table 26–1. Configuration Structures (Macros)

Syntax	Type	Description	See page
VP_Config	T	Structure used to configure video port peripherals	26-4
VP_ConfigCapture	T	Structure used to configure video capture mode	26-4
VP_ConfigCaptureChA	T	Structure used to configure the Channel A video capture mode	26-5
VP_ConfigCaptureChB#	T	Structure used to configure the Channel B video capture mode	26-5
VP_ConfigCaptureTSI	T	Structure used to configure the transport stream interface (TSI) capture mode	26-6
VP_ConfigDisplay	T	Structure used to configure video display mode	26-7
VP_ConfigGpio	T	Structure used to enable use of VP pins for GPIO	26-8
VP_ConfigPort	T	Structure used to configure video port control and interrupt registers	26-8

Defined only for DM642

Table 26–2. VP APIs and Constants

Syntax	Type	Description	See page
VP_OPEN_RESET	C	VP reset flag used while opening	26-9
VP_clearPins	F	Writes value to PDCLR	26-9
VP_close	F	Closes previously opened VP device	26-9
VP_config	F	Configure VP using configuration structure	26-10
VP_configCapture	F	Configures capture mode of video port	26-10
VP_configCaptureChA	F	Configures capture mode of Channel A of video port	26-11
VP_configCaptureChB#	F	Configures capture mode of Channel B of video port	26-11

Syntax	Type	Description	See page
VP_configCaptureTSI	F	Configures transfer stream interface (TSI) mode of video port	26-12
VP_configDisplay	F	Sets display characteristics for video port	26-12
VP_configGpio	F	Enables pins to be used as GPIO pins	26-13
VP_configPort	F	Configures port characteristics of VP	26-13
VP_getCbdstAddr	F	Gets the address of the Cb FIFO Destination Register	26-14
VP_getCbsrcaAddr	F	Gets the address of the Cb FIFO Source Register A	26-14
VP_getCbsrcbAddr#	F	Gets the address of the Cb FIFO Source Register B	26-14
VP_getConfig	F	Reads the VP configuration values	26-15
VP_getCrdstAddr	F	Gets the address of the Cr FIFO Destination Register	26-15
VP_getCrsrcaAddr	F	Gets the address of the Cr FIFO Source Register A	26-16
VP_getCrsrcbAddr#	F	Gets the address of the Cr FIFO Source Register B	26-16
VP_getEventId	F	Gets event id specified in device handle	26-17
VP_getPins	F	Returns value of PDIN. This reflects the state of the video port pins.	26-17
VP_getYdstaAddr	F	Gets the address of the Y FIFO Destination Register A	26-18
VP_getYdstbAddr	F	Gets the address of the Y FIFO Destination Register B	26-18
VP_getYsrcaAddr	F	Gets the address of the Y FIFO Source Register A	26-19
VP_getYsrcbAddr#	F	Gets the address of the Y FIFO Source Register B	26-19
VP_open	F	Opens VP device for use	26-20
VP_reset	F	Resets the VP device	26-20
VP_resetAll	F	Resets all video ports	26-21
VP_resetCaptureChA	F	Resets the Capture Channel A and disables all its interrupts	26-21
VP_resetCaptureChB#	F	Resets the Capture Channel B and disables all its interrupts	26-21
VP_resetDisplay	F	Resets the video display module and disables all its interrupts	26-22
VP_setPins	F	Writes value to PDSET	26-22

Defined only for DM642

VP_Config

26.2 Configuration Structures

VP_Config *Structure used to configure video port peripheral*

Members	VP_ConfigPort	*port Port Address
	VP_ConfigCapture	*capture Video Capture Mode Configuration
	VP_ConfigDisplay	*display Video Display Mode Configuration
	VP_ConfigGpio	*gpio Configures pins used for GPIO
Description	This is the VP configuration structure used to configure Video Port(s). You create and initialize this structure and then pass its address to the VP_config function.	

VP_ConfigCapture *Display code at selected address*

Members	Uint32 vcactl	Video Capture Channel A Control Register
	Uint32 vcastrt1	Video Capture Channel A Field 1 Start Register
	Uint32 vcastop1	Video Capture Channel A Field 1 Stop Register
	Uint32 vcastrt2	Video Capture Channel A Field 2 Start Register
	Uint32 vcastop2	Video Capture Channel A Field 2 Stop Register
	Uint32 vcavint	Video Capture Channel A Vertical Interrupt Register
	Uint32 vcathrld	Video Capture Channel A Threshold Register
	Uint32 vcaevtct	Video Capture Channel A Event Count Register
	Uint32 vcbctl#	Video Capture Channel B Control Register
	Uint32 vcbstr1#	Video Capture Channel B Field 1 Start Register
	Uint32 vcbstop1#	Video Capture Channel B Field 1 Stop Register
	Uint32 vcbstr2#	Video Capture Channel B Field 2 Start Register
	Uint32 vcbstop2#	Video Capture Channel B Field 2 Stop Register
	Uint32 vcbvint#	Video Capture Channel B Vertical Interrupt Register
	Uint32 vcbthrd#	Video Capture Channel B Threshold Register
	Uint32 vcbvtct#	Video Capture Channel B Event Count Register
	# Defined only for DM642	
	Uint32 tsictl	TSI Capture Control Register
	Uint32 tsiclkinl	TSI Clock Initialization LSB Register
	Uint32 tsiclkinlmsb	TSI Clock Initialization MSB Register
	Uint32 tsistcmpl	TSI System Time Clock Compare LSB Register
	Uint32 tsistcmplmsb	TSI System Time Clock Compare MSB Register
	Uint32 tsistmskl	TSI System Time Clock Compare Mask LSB Register
	Uint32 tsistmsklmsb	TSI System Time Clock Compare Mask MSB Register
	Uint32 tsiticks	TSI System Time Clock Ticks Interrupt Register

VP_ConfigCaptureChA

Description This structure is used to configure the Video Port Capture Mode. This is used as a parameter in VP_Config.

VP_ConfigCaptureChA *Structure used to configure the channel A video capture mode*

Members	Uint32 vcactl	Video Capture Channel A Control Register
	Uint32 vcastrt1	Video Capture Channel A Field 1 Start Register
	Uint32 vcastop1	Video Capture Channel A Field 1 Stop Register
	Uint32 vcastrt2	Video Capture Channel A Field 2 Start Register
	Uint32 vcastop2	Video Capture Channel A Field 2 Stop Register
	Uint32 vcavint	Video Capture Channel A Vertical Interrupt Register
	Uint32 vcathrld	Video Capture Channel A Threshold Register
	Uint32 vcaevtct	Video Capture Channel A Event Count Register

Description This structure is used to configure the Channel A Video Port Capture Mode.

VP_ConfigCaptureChB *Structure used to configure the channel B video capture mode#*

Members	Uint32 vcbctl	Video Capture Channel B Control Register
	Uint32 vcbstrt1	Video Capture Channel B Field 1 Start Register
	Uint32 vcbstop1	Video Capture Channel B Field 1 Stop Register
	Uint32 vcbstrt2	Video Capture Channel B Field 2 Start Register
	Uint32 vcbstop2	Video Capture Channel B Field 2 Stop Register
	Uint32 vcbvint	Video Capture Channel B Vertical Interrupt Register
	Uint32 vcbthrld	Video Capture Channel B Threshold Register
	Uint32 vcbevtct	Video Capture Channel B Event Count Register

Description This structure is used to configure the channel B video capture mode VP_ConfigCaptureChB#.

#Defined only for DM642

VP_ConfigCaptureTSI

VP_ConfigCaptureTSI *Structure used to configure the transport stream interface mode (TSI) capture mode*

Members	Uint32 vcactl	Video Capture Channel A Control Register
	Uint32 tsictl	TSI Capture Control Register
	Uint32 tsiclknitl	TSI Clock Initialization LSB Register
	Uint32 tsiclknitm	TSI Clock Initialization MSB Register
	Uint32 tsistcmpl	TSI System Time Clock Compare LSB Register
	Uint32 tsistcmpm	TSI System Time Clock Compare MSB Register
	Uint32 tsistmskl	TSI System Time Clock Compare Mask LSB Register
	Uint32 tsistmskm	TSI System Time Clock Compare Mask MSB Register
	Uint32 tsiticks	TSI System Time Clock Ticks Interrupt Register
Description	This structure is used to configure the transport stream interface mode (TSI) port capture mode.	

VP_ConfigDisplay *Structure used to configure video display mode*

Members	Uint32 vdctl	Video Display Control Register
	Uint32 vdfmsz	Video Display Frame Size Register
	Uint32 vdhblk	Video Display Horizontal Blanking Register
	Uint32 vdvblks1	Video Display Field 1 Vertical Blanking Start Register
	Uint32 vdvblke1	Video Display Field 1 Vertical Blanking End Register
	Uint32 vdvblks2	Video Display Field 2 Vertical Blanking Start Register
	Uint32 vdvblke2	Video Display Field 2 Vertical Blanking End Register
	Uint32 vdimoff1	Video Display Field 1 Image Offset Register
	Uint32 vdimgsz1	Video Display Field 1 Image Size Register
	Uint32 vdimoff2	Video Display Field 2 Image Offset Register
	Uint32 vdimgsz2	Video Display Field 2 Image Size Register
	Uint32 vdfldt1	Video Display Field 1 Timing Register
	Uint32 vdfldt2	Video Display Field 2 Timing Register
	Uint32 vdthrd	Video Display Threshold Register
	Uint32 vdhsync	Video Display Horizontal Sync Register
	Uint32 vdvsyns1	Video Display Field 1 Vertical Sync Start Register
	Uint32 vdvsyne1	Video Display Field 1 Vertical Sync End Register
	Uint32 vdvsyns2	Video Display Field 2 Vertical Sync Start Register
	Uint32 vdvsyne2	Video Display Field 2 Vertical Sync End Register
	Uint32 vdreload	Video Display Counter Reload Register
	Uint32 vddispevt	Video Display Display Event Register
	Uint32 vdclip	Video Display Clipping Register
	Uint32 vddefval	Video Display Default Display Value Register
	Uint32 vdvint	Video Display Vertical Interrupt Register
	Uint32 vdfbit	Video Display Field Bit Register
	Uint32 vdvbit1	Video Display Field 1 Vertical Blanking Bit Register
	Uint32 vdvbit2	Video Display Field 2 Vertical Blanking Bit Register

Description This structure is used to configure the Video Display Mode. This is used as a parameter in VP_Config.

VP_ConfigGpio

VP_ConfigGpio

Structure used to enable use of VP pins for GPIO

Members

Uint32 pfunc	Video Port Pin Function Register
Uint32 pdir	Video Port GPIO Direction Control Register
Uint32 pdout	Video Port GPIO Data Output Register
Uint32 pdset	Video Port GPIO Data Set Register
Uint32 pdclr	Video Port GPIO Data Clear Register
Uint32 pien	Video Port GPIO Interrupt Enable Register
Uint32 pipol	Video Port GPIO Interrupt Polarity Register
Uint32 piclr	Video Port GPIO Interrupt Clear Register

Description

Signals not used for Video display and capture can be used as GPIO pins. The GPIO register set includes registers to set for using pins in GPIO mode. This structure is used as a parameter in VP_Config.

VP_ConfigPort

Structure used to configure video port control and interrupt registers

Members

Uint32 vpctl	Video Port Control Register
Uint32 vpie	Video Port Interrupt Enable Register
Uint32 vpis	Video Port Interrupt Status Register

Description

This structure is used to configure the video port control and interrupt registers. This is used as a parameter in VP_Config.

26.3 Functions and Constants

VP_OPEN_RESET *VP reset flag, used while opening*

Description This flag is used while opening VP device To open with reset; use VP_OPEN_RESET; otherwise use 0

Example See VP_open

VP_clearPins *Writes value to PDCLR*

Function void VP_clearPins(
VP_Handle hVP,
Uint32 val
)

Arguments hVP Device Handle; see VP_open
val Value to be written to PDCLR

Return Value None

Description Writes value to PDCLR. Writing a 1 to a bit of PDCLR clears the corresponding bit in PDOUT. Writing a 0 has no effect.

Example

```
VP_Handle hVP;  
Uint32 val;  
...  
VP_clearPins(hVP, val);
```

VP_close *Closes previously opened VP device*

Function void VP_close(
VP_Handle hVP
)

Arguments hVP Device handle; see VP_open

Return Value None

Description Closes a previously opened VP device (see VP_open).
The following tasks are performed:
The VP event is disabled and cleared
The VP registers are set to their default values

Example

```
VP_close(hVP);
```

VP_config

VP_config *Configure VP using configuration structure*

Function	<pre>void VP_config(VP_Handle hVP, VP_Config *myConfig)</pre>
Arguments	hVP Device Handle; see VP_open myConfig; see VP_Config
Return Value	None
Description	Configure the Video Port
Example	<pre>VP_Config myConfig; VP_Handle hVP; VP_config(hVP, &myConfig);</pre>

VP_configCapture *Configures capture mode of video port*

Function	<pre>void VP_configCapture(VP_Handle hVP, VP_ConfigCapture *myPort)</pre>
Arguments	hVP Device Handle; see VP_open myPort; see VP_ConfigCapture
Return Value	None
Description	Used to configure the Capture mode of Video Port.
Example	<pre>VP_ConfigCapture myCapture; VP_Handle hVP; VP_configCapture(hVP, &myCapture);</pre>

VP_configCaptureChA *Configures capture mode of channel A of video port*

Function	<pre>void VP_configCaptureChA(VP_Handle hVP, VP_ConfigCaptureChA *myCaptureChA)</pre>
Arguments	hVP Device Handle; see VP_open myCaptureChA; see VP_ConfigCaptureChA
Return Value	None
Description	Used to configure the capture mode of Channel A of video port
Example	<pre>VP_ConfigCaptureChA myCaptureChA; VP_Handle hVP; VP_configCaptureChA(hVP, &myCaptureChA);</pre>

VP_configCaptureChB *Configures capture mode of channel B of video port#*

Function	<pre>void VP_configCaptureChB(VP_Handle hVP, VP_ConfigCaptureChB *myCaptureChB)</pre>
Arguments	hVP Device Handle; see VP_open myCaptureChB; see VP_ConfigCaptureChB
Return Value	None
Description	Used to configure the capture mode of Channel B of video port
Example	<pre>VP_ConfigCaptureChB myCaptureChB; VP_Handle hVP; VP_configCaptureChB(hVP, &myCaptureChB);</pre>

Defined only for DM642

VP_configCaptureTSI

VP_configCaptureTSI *Configures Transfer stream interface (TSI) mode of video port*

Function	<code>void VP_configCaptureTSI(VP_Handle hVP, VP_ConfigCaptureTSI *myCaptureTSI)</code>
Arguments	hVP Device Handle; see VP_open myCaptureTSI; see VP_ConfigCaptureTSI
Return Value	None
Description	Used to configure the transfer stream interface (TSI) mode of video port
Example	<pre>VP_ConfigCaptureTSI myCaptureTSI; VP_Handle hVP; VP_configCaptureTSI(hVP, &myCaptureTSI);</pre>

VP_configDisplay *Sets display characteristics for video port*

Function	<code>void VP_configDisplay(VP_Handle hVP, VP_ConfigDisplay *myDisplay)</code>
Arguments	hVP Device Handle; see VP_open myDisplay; see VP_ConfigDisplay
Return Value	None
Description	Used to configure the display settings of video port
Example	<pre>VP_ConfigDisplay myDisplay; VP_Handle hVP; VP_configDisplay(hVP, &myDisplay);</pre>

VP_configGpio *Enables pins to be Used as GPIO pins*

Function	<pre>void VP_configGpio(VP_Handle hVP, VP_ConfigGpio *myGpio)</pre>
Arguments	hVP Device Handle; see VP_open myGpio; see VP_ConfigGpio
Return Value	None
Description	Enables pins to be used as GPIO pins
Example	<pre>VP_ConfigGpio myGpio; VP_Handle hVP; VP_configGpio(hVP, &myGpio);</pre>

VP_configPort *Configures port characteristics of VP*

Function	<pre>void VP_configPort(VP_Handle hVP, VP_ConfigPort *myPort)</pre>
Arguments	hVP Device Handle; see VP_open myPort; see VP_ConfigPort
Return Value	None
Description	Used to configure the port characteristics of video port
Example	<pre>VP_ConfigPort myPort; VP_Handle hVP; VP_configPort(hVP, &myPort);</pre>

VP_getCbdstAddr

VP_getCbdstAddr *Gets the address of the Cb FIFO destination register*

Function `UInt32 VP_getCbdstAddr(
 VP_Handle hVP
)`

Arguments `hVP Device Handle; see VP_open`

Return Value `UInt32`

Description `Gets the address of the Cb FIFO destination register`

Example `VP_Handle hVP;
 UInt32 getVal;
 getVal = VP_getCbdstAddr(hVP);`

VP_getCbsrcaAddr *Gets the address of the Cb FIFO source register A*

Function `UInt32 VP_getCbsrcaAddr(
 VP_Handle hVP
)`

Arguments `hVP Device Handle; see VP_open`

Return Value `UInt32`

Description `Gets the address of the Cb FIFO source Register A`

Example `VP_Handle hVP;
 UInt32 getVal;
 getVal = VP_getCbsrcaAddr(hVP);`

VP_getCbsrcbAddr *Gets the address of the Cb FIFO source register B#*

Function `UInt32 VP_getCbsrcbAddr(
 VP_Handle hVP
)`

Arguments `hVP Device Handle; see VP_open`

Return Value `UInt32`

Description `Gets the address of the Cb FIFO source Register B`

Example `VP_Handle hVP;
 UInt32 getVal;
 getVal = VP_getCbsrcbAddr(hVP);`

Defined only for DM642

VP_getConfig *Reads the VP configuration values*

Function	<pre>void VP_getConfig(VP_Handle hVP, VP_Config *myConfig)</pre>
Arguments	hVP Device Handle; see VP_open myConfig; see VP_Config
Return Value	None
Description	Gets the current VP configuration values
Example	<pre>VP_Config vpCfg; VP_getConfig(hVP, &vpCfg);</pre>

VP_getCrdstAddr *Gets the address of the Cr FIFO destination register*

Function	<pre>UInt32 VP_getCrdstAddr(VP_Handle hVP)</pre>
Arguments	hVP Device Handle; see VP_open
Return Value	UInt32
Description	Gets the address of the Cr FIFO destination register
Example	<pre>VP_Handle hVP; UInt32 getVal; getVal = VP_getCrdstAddr(hVP);</pre>

VP_getCrsrcaAddr

VP_getCrsrcaAddr *Gets the address of the Cr FIFO source register A*

Function `UInt32 VP_getCrsrcaAddr(
 VP_Handle hVP
)`

Arguments `hVP Device Handle; see VP_open`

Return Value `UInt32`

Description `Gets the address of the Cr FIFO source Register A`

Example `VP_Handle hVP;
 UInt32 getVal;
 getVal = VP_getCrsrcaAddr(hVP);`

VP_getCrsrcaAddr *Gets the address of the Cr FIFO source register A*

Function `UInt32 VP_getCrsrcaAddr(
 VP_Handle hVP
)`

Arguments `hVP Device Handle; see VP_open`

Return Value `UInt32`

Description `Gets the address of the Cr FIFO source Register B`

Example `VP_Handle hVP;
 UInt32 getVal;
 getVal = VP_getCrsrcaAddr(hVP);`

`# Defined only for DM642`

VP_getEventID *Gets event id specified in device handle*

Function `Uint32 VP_getEventId(
 VP_Handle hVP
)`

Arguments `hVP Device Handle; see VP_open`

Return Value `Uint32`

Description `Gets event id specified in device handle`

Example `VP_Handle hVP;
 Uint32 evtId;
 evtId = VP_getEventId(hVP);`

VP_getPins *Returns value of PDIN. This reflects the state of the video port pins*

Function `Uint32 VP_getPins(
 VP_Handle hVP
)`

Arguments `hVP Device Handle; see VP_open`

Return Value `Uint32`

Description `Returns value of PDIN. This reflects the state of the video port pins.`

Example `VP_Handle hVP;
 Uint32 getVal;
 getVal = VP_getPins(hVP);`

VP_getYdstaAddr

VP_getYdstaAddr *Gets the address of the Y FIFO destination register A*

Function `UInt32 VP_getYdstaAddr(
 VP_Handle hVP
)`

Arguments `hVP Device Handle; see VP_open`

Return Value `UInt32`

Description `Gets the address of the Y FIFO destination Register A`

Example `VP_Handle hVP;
 UInt32 getVal;
 getVal = VP_getYdstaAddr(hVP);`

VP_getYdstbAddr *Gets the address of the Y FIFO destination register B#*

Function `UInt32 VP_getYdstbAddr(
 VP_Handle hVP
)`

Arguments `hVP Device Handle; see VP_open`

Return Value `UInt32`

Description `Gets the address of the Y FIFO destination Register B`

Example `VP_Handle hVP;
 UInt32 getVal;
 getVal = VP_getYdstbAddr(hVP);`

`#Defined only for DM642`

VP_getYsrcaAddr *Gets the address of the Y FIFO source register A*

Function	Uint32 VP_getYsrcaAddr(VP_Handle hVP)
Arguments	hVP Device Handle; see VP_open
Return Value	Uint32
Description	Gets the address of the Y FIFO source Register A
Example	<pre>VP_Handle hVP; Uint32 getVal; getVal = VP_getYsrcaAddr(hVP);</pre>

VP_getYsrcbAddr *Gets the address of the Y FIFO source register B#*

Function	Uint32 VP_getYsrcbAddr(VP_Handle hVP)
Arguments	hVP Device Handle; see VP_open
Return Value	Uint32
Description	Gets the address of the Y FIFO source Register B
Example	<pre>VP_Handle hVP; Uint32 getVal; getVal = VP_getYsrcbAddr(hVP);</pre> <p>#Defined only for DM642</p>

VP_open

VP_open

Opens VP device for use

Function	VP_Handle VP_open(Uint16 devNum, Uint16 flags))
Arguments	devNum specifies the device to be opened flags Open flags OPEN_RESET : resets the VP
Return Value	VP_Handle Device Handle INV : open failed
Description	Before the VP device can be used, it must be 'opened' using this function. Once opened it cannot be opened again until it is 'closed' (see VP_close). The return value is a unique device handle that is used in subsequent VP API calls. If the open fails, 'INV' is returned. If the OPEN_RESET flag is specified, the VP module registers are set to their power-on defaults and any associated interrupts are disabled and cleared.
Example	<pre>Handle hVP; ... hVP = VP_open(OPEN_RESET);</pre>

VP_reset

Resets the VP device

Function	void VP_reset(VP_Handle hVP))
Arguments	hVP Device Handle; see VP_open
Return Value	None
Description	Sets the VP registers to their default values
Example	<pre>VP_Handle hVP; ... VP_reset(hVP);</pre>

VP_resetAll *Resets all video ports*

Function	void VP_resetAll()
Return Value	None
Description	Resets all video ports
Example	VP_resetAll();

VP_resetCaptureChA *Resets the capture channel A and disables all its interrupts*

Function	void VP_resetCaptureChA(VP_Handle hVP)
Arguments	hVP Device Handle; see VP_open
Return Value	None
Description	Resets the channel bit in VCACTL, disables interrupts for this channel and clears status bits in VPIS set for this channel. All further DMA event generation is blocked and the FIFO is flushed upon completion of pending DMA events.
Example	VP_Handle hVP; VP_resetCaptureChA(hVP);

VP_resetCaptureChB *Resets the capture channel B and disables all its interrupts#*

Function	void VP_resetCaptureChB(VP_Handle hVP)
Arguments	hVP Device Handle; see VP_open
Return Value	None
Description	Resets the channel bit in VCBCTL, disables interrupts for this channel and clears status bits in VPIS set for this channel. All further DMA event generation is blocked and the FIFO is flushed upon completion of pending DMA events.
Example	VP_Handle hVP; VP_resetCaptureChB(hVP); #Defined only for DM642

VP_resetDisplay

VP_resetDisplay *Resets the video display module and disables all its interrupts*

Function	<code>void VP_resetDisplay(VP_Handle hVP)</code>
Arguments	hVP Device Handle; see VP_open
Return Value	None
Description	Resets the video display module and sets its registers to their initial values. All related interrupts are disabled and the status bits set in VPIS are cleared
Example	<pre>VP_Handle hVP; VP_resetDisplay(hVP);</pre>

VP_setPins *Writes value to PDSET*

Function	<code>void VP_setPins(VP_Handle hVP, Uint32 val)</code>
Arguments	hVP Device Handle; see VP_open val Value to be written to PDSET
Return Value	None
Description	Writes value to PDSET. Writing a 1 to a bit of PDSET sets the corresponding bit in PDOUT. Writing a 0 has no effect.
Example	<pre>VP_Handle hVP; Uint32 val; ... VP_setPins(hVP, val);</pre>

XBUS Module

This chapter describes the XBUS module, lists the API functions and macros within the module, discusses how to use the XBUS device, and provides an XBUS API reference section.

Topic	Page
27.1 Overview	27-2
27.2 Macros	27-2
27.3 Configuration Structure	27-4
27.4 Functions	27-5

27.1 Overview

This module has a simple API for configuring the XBUS registers. The XBUS may be configured by passing an `XBUS_CONFIG` structure to `XBUS_Config()` or by passing register values to the `XBUS_ConfigArgs()` function.

Table 27–1 lists the configuration structure for use with the XBUS functions. Table 27–2 lists the functions and constants available in the CSL DMA module.

Table 27–1. XBUS Configuration Structure

Syntax	Type	Description	See page ...
<code>XBUS_Config</code>	S	XBUS configuration structure	27-4

Table 27–2. XBUS APIs

Syntax	Type	Description	See page ...
<code>XBUS_config</code>	F	Configures entry for XBUS configuration structure	27-5
<code>XBUS_configArgs</code>	F	Configures entry for XBUS registers	27-5
<code>XBUS_getConfig</code>	F	Returns the current XBUS configuration structure	27-6
<code>XBUS_SUPPORT</code>	C	Compile time constant	27-7

Note: F = Function; C = Constant

27.2 Macros

There are two types of XBUS macros: those that access registers and fields, and those that construct register and field values.

Table 27–3 lists the XBUS macros that access registers and fields, and Table 27–4 lists the XBUS macros that construct register and field values. The macros themselves are found in Chapter 28, *Using the HAL Macros*.

XBUS macros are not handle-based.

Table 27–3. XBUS Macros that Access Registers and Fields

Macro	Description/Purpose	See page ...
XBUS_ADDR(<REG>)	Register address	28-12
XBUS_RGET(<REG>)	Returns the value in the peripheral register	28-18
XBUS_RSET(<REG>,x)	Register set	28-20
XBUS_FGET(<REG>,<FIELD>)	Returns the value of the specified field in the peripheral register	28-13
XBUS_FSET(<REG>,<FIELD>,fieldval)	Writes <i>fieldval</i> to the specified field in the peripheral register	28-15
XBUS_FSETS(<REG>,<FIELD>,<SYM>)	Writes the symbol value to the specified field in the peripheral	28-17
XBUS_RGETA(addr,<REG>)	Gets register for a given address	28-19
XBUS_RSETA(addr,<REG>,x)	Sets register for a given address	28-20
XBUS_FGETA(addr,<REG>,<FIELD>)	Gets field for a given address	28-13
XBUS_FSETA(addr,<REG>,<FIELD>,fieldval)	Sets field for a given address	28-16
XBUS_FSETSA(addr,<REG>,<FIELD>,<SYM>)	Sets field symbolically for a given address	28-17

Table 27–4. XBUS Macros that Construct Register and Field Values

Macro	Description/Purpose	See page ...
XBUS_<REG>_DEFAULT	Register default value	28-21
XBUS_<REG>_RMK()	Register make	28-23
XBUS_<REG>_OF()	Register value of ...	28-22
XBUS_<REG>_<FIELD>_DEFAULT	Field default value	28-24
XBUS_FMK()	Field make	28-14
XBUS_FMKS()	Field make symbolically	28-15
XBUS_<REG>_<FIELD>_OF()	Field value of ...	28-24
XBUS_<REG>_<FIELD>_<SYM>	Field symbolic value	28-24

27.3 Configuration Structure

XBUS_Config *XBUS configuration structure*

Structure	XBUS_Config	
Members	UInt32 xbgc	Expansion Bus global control register value
	UInt32 xce0ctl	XCE0 space control register value
	UInt32 xce1ctl	XCE1 space control register value
	UInt32 xce2ctl	XCE2 space control register value
	UInt32 xce3ctl	XCE3 space control register value
	UInt32 xbhcn	Expansion Bus host port interface control register value
	UInt32 xanima	Expansion Bus internal master address register value
	UInt32 xbea	Expansion Bus external address register value

Description This is the XBUS configuration structure used to set up an XBUS configuration. You create and initialize this structure then pass its address to the `XBUS_config()` function.

Example

```
XBUS_Config xbusCfg = {
    0x00000000, /* Global Control Register(XBGC) */
    0xFFFF3F23, /* XCE0 Space Control Register(XCE0CTL) */
    0xFFFF3F23, /* XCE1 Space Control Register(XCE1CTL) */
    0xFFFF3F23, /* XCE2 Space Control Register(XCE2CTL) */
    0xFFFF3F23, /* XCE3 Space Control Register(XCE3CTL) */
    0x00000000, /* XBUS HPI Control Register(XBHC) */
    0x00000000, /* XBUS Internal Master Address
                Register(XBIMA) */
    0x00000000 /* XBUS External Address Register(XBEA) */
};
.
.
XBUS_config(&xbusCfg);
```

27.4 Functions

XBUS_config *Establishes XBUS configuration structure*

Function	void XBUS_config(XBUS_Config *config);
Arguments	config Pointer to an initialized configuration structure
Return Value	none
Description	Sets up the XBUS using the configuration structure. The values of the structure are written to the XBUS registers.
Example	<pre> XBUS_Config xbusCfg = { 0x00000000, /* Global Control Register(XBGC) */ 0xFFFF3F23, /* XCE0 Space Control Register(XCE0CTL) */ 0xFFFF3F23, /* XCE1 Space Control Register(XCE1CTL) */ 0xFFFF3F23, /* XCE2 Space Control Register(XCE2CTL) */ 0xFFFF3F23, /* XCE3 Space Control Register(XCE3CTL) */ 0x00000000, /* XBUS HPI Control Register(XBHC) */ 0x00000000, /* XBUS Internal Master Address Register(XBIMA) */ 0x00000000 /* XBUS External Address Register(XBEA) */ }; XBUS_config(&xbusCfg); </pre>

XBUS_configArgs *Establishes XBUS register value*

Function	void XBUS_configArgs(Uint32 xbgc, Uint32 xce0ctl, Uint32 xce1ctl, Uint32 xce2ctl, Uint32 xce3ctl, Uint32 xbhc, Uint32 xbima, Uint32 xbea);
-----------------	---

XBUS_getConfig

Arguments	<code>xbgc</code>	Expansion Bus global control register value
	<code>xce0ctl</code>	XCE0 space control register value
	<code>xce1ctl</code>	XCE1 space control register value
	<code>xce2ctl</code>	XCE2 space control register value
	<code>xce3ctl</code>	XCE3 space control register value
	<code>xbhc</code>	Expansion Bus host port interface control register value
	<code>xbima</code>	Expansion Bus internal master address register value
	<code>xbea</code>	Expansion Bus external address register value

Return Value none

Description Sets up the XBUS using the register values passed in. The register values are written to the XBUS registers.

Example

```
xbgc = 0x00000000;
xce0ctl = 0xFFFF3F23;
xce1ctl = 0xFFFF3F23;
xce2ctl = 0xFFFF3F23;
xce3ctl = 0xFFFF3F23;
xbhc = 0x00000000;
xbima = 0x00000000;
xbea = 0x00000000;
XBUS_configArgs (
    xbgc,
    xce0ctl,
    xce1ctl,
    xce2ctl,
    xce3ctl,
    xbhc,
    xbima,
    xbea
);
```

XBUS_getConfig *Gets XBUS current configuration value*

Function void XBUS_getConfig(
 XBUS_Config *config
);

Arguments config Pointer to a configuration structure

Return Value none

Description Get XBUS current configuration value.

Example

```
XBUS_config xbusCfg;
XBUS_getConfig(&xbusCfg);
```

XBUS_SUPPORT *Compile time constant*

Constant XBUS_SUPPORT

Description The compile time constant has a value of 1 if the device supports the XBUS module, and 0 otherwise. You are not required to use this constant.

Example

```
#if (XBUS_SUPPORT)
    /* user XBUS configuration */
#endif
```

Using the HAL Macros

This chapter describes the hardware abstraction layer (HAL), gives a summary of the HAL macros, discusses RMK macros and macro token pasting, and provides a HAL macro reference section.

Topic	Page
28.1 Introduction	28-2
28.2 Generic Macro Notation and Table of Macros	28-4
28.3 General Comments Regarding HAL Macros	28-6
28.4 HAL Macro Reference	28-12

28.1 Introduction

The chip support library (CSL) has two layers: the service layer and the hardware abstraction layer (HAL). The service layer contains the API functions, data types, and constants as defined in the various chapters of this reference guide. The HAL is made up of a set of header files that define an orthogonal set of C macros and constants which abstract registers and bit-fields into symbols.

28.1.1 HAL Macro Symbols

These HAL macro symbols define memory-mapped register addresses, register bit-field mask and shift values, symbolic names for bit-field values, and access macros for reading/writing registers and individual bit-fields. In other high-level OS environments, HAL usually refers to a set of functions that completely abstract hardware. In the context of the CSL, the abstraction is limited to processor-dependent changes of register/bit-field definitions. For example, if a bit-field changes width from one chip to another, this is reflected in the HAL macros. If a memory-mapped register is specific to a chip, the register is described in the HAL file with a condition. For example, the memory-mapped register SDEXT (EMIF register) is supported only by 6211 and 6711 devices, and the register description is set for these devices with a condition access. Devices other than 6211/6711 cannot access the abstract macros related to the SDEXT register.

Prior to the HAL definition, almost all application programmers found themselves defining a HAL in one form or another. Users would go through and add many symbols (*#defines*) to map registers, and they would define bit-field positions and values. Consequently, that process generated a large development time for programmers, all with their own HAL macros and no standardization. With the development of the CSL, TI has generated a set of HAL macros and made it available to all users in order to make peripheral configuration easy. The HAL macros add a level of compatibility and standardization and, more importantly, reduce development time.

28.1.2 HAL Header Files

The HAL macros are defined in the HAL header file (e.g., `csl_dmahal.h`, `csl_mcbssphal.h`, etc.) The user does not directly include these files; instead, the service layer header file is included, which indirectly includes the HAL file. For example, if the DMA HAL file is needed (`csl_dmahal.h`), include `csl_dma.h`, which will indirectly include `csl_dmahal.h`.

The HAL is nothing more than a large set of C macros; there is no compiled C code involved. In an application where only the HAL gets used, the result will be that zero CSL library code gets linked in.

28.1.3 HAL Macro Summary

TMS320C6000™ CSL macros can be divided into two functionality groups:

- **Macros that access registers and fields** (set, get). These macros are implemented at the beginning of the HAL files and include:
 - Macro for reading a register
 - Macro for writing to a register
 - Macro that returns the address of a memory-mapped register
 - Macro for inserting a field value into a register
 - Macro for extracting a field value from a register
 - Macro for inserting a field value into a register using a symbolic name
 - Variations of the above for handle-based registers
 - Variations of the above for given register addresses
- **Macros that construct register and field values.** These macros are register-specific and implemented for each value. They include:
 - Macro constant for the default value of a register
 - Macro that constructs register values based on field values
 - Macro constant for the default value of a register field
 - Macro that constructs a field value
 - Macro that constructs a field value given a symbolic constant

28.2 Generic Macro Notation and Table of Macros

Table 28–1 lists the macros defined in the HAL using the following generic notation:

- ❑ <PER> = placeholder for peripheral (module) name: DMA, MCBSP, IRQ, etc.
- ❑ <REG> = placeholder for a register name: PRICTL, SPCR, AUXCTL, etc.
- ❑ <FIELD> = placeholder for a field name: PRI, STATUS, XEMPTY, etc.
- ❑ <SYM> = placeholder for a value name: ENABLE, YES, HIGH, etc.

<PER> represents a placeholder for the peripheral (module) name; i.e., DMA, MCBSP, etc. When the table lists something like <PER>_ADDR, it actually represents a whole set of macros defined in the different modules: DMA_ADDR(...), MCBSP_ADDR(...), etc. Likewise, whenever <REG> is used, it is a placeholder for a register name. For example, <PER>_<REG>_DEFAULT represents a set of macros including DMA_AUXCTL_DEFAULT, MCBSP_SPCR_DEFAULT, TIMER_CTL_DEFAULT, etc. There are also field name place holders such as in the macro <PER>_<REG>_<FIELD>_DEFAULT. In this case it represents a set of macros including: DMA_PRICTL_PRI_DEFAULT, MCBSP_SPCR_GRST_DEFAULT, etc.

Table 28–1. CSL HAL Macros

HAL Macro Type	Purpose	See page ...
<PER>_ADDR	Register Address	28-12
<PER>_ADDRH	Register Address For Given Handle	28-12
<PER>_CRGET	Gets the Value of CPU Register	28-12
<PER>_CRSET	Sets the Value of CPU Register	28-13
<PER>_FGET	Field Get	28-13
<PER>_FGETA	Field Get Given Address	28-13
<PER>_FGETH	Field Get For Given Handle	28-14
<PER>_FMK	Field Make	28-14
<PER>_FMKS	Field Make Symbolically	28-15
<PER>_FSET	Field Set	28-15
<PER>_FSETA	Field Set Given Address	28-16
<PER>_FSETH	Field Set For Given Handle	28-16
<PER>_FSETS	Field Set Symbolically	28-17
<PER>_FSETSA	Field Set Symbolically For Given Address	28-17
<PER>_FSETSH	Field Set Symbolically For Given Handle	28-18
<PER>_RGET	Register Get	28-18
<PER>_RGETA	Register Get Given Address	28-19
<PER>_RGETH	Register Get For Given Handle	28-19
<PER>_RSET	Register Set	28-20
<PER>_RSETA	Register Set Given Address	28-20
<PER>_RSETH	Register Set For Given Handle	28-21
<PER>_<REG>_DEFAULT	Register Default Value	28-21
<PER>_<REG>_OF	Register Value Of ...	28-22
<PER>_<REG>_RMK	Register Make	28-23
<PER>_<REG>_<FIELD>_DEFAULT	Field Default Value	28-24
<PER>_<REG>_<FIELD>_OF	Field Value Of ...	28-24
<PER>_<REG>_<FIELD>_<SYM>	Field Symbolic Value	28-24

28.3 General Comments Regarding HAL Macros

This section contains some general comments of interest regarding the HAL macros.

28.3.1 Right-Justified Fields

Whenever field values are referenced, they are always right-justified. This makes it easier to deal with them and it also adds some processor independence. To illustrate, consider the following:

Assume that you have a register (MYREG) in a peripheral named MYPER with a field that spans bits 17 to 21 – a 5-bit field named (MYFIELD). Also assume that this field can take on three valid values, 00000b = V1, 01011b = V2, and 11111b = V3. It will look like this:

MYREG:



If you wanted to extract this field, you would first mask the register value with 0x003E0000 then right-shift it by 17 bits. This would give the right-justified field value.

If you start with the right justified field value and want to create the in-place field value, you would first left-shift it by 17 bits then mask it with 0x003E0000.

If we had HAL macros for this hypothetical register, then we would have a MYPER_FGET(MYREG, MYFIELD) macro that would return the MYFIELD value right-justified. We would also have the MYPER_FSET(MYREG, MYFIELD, x) macro that accepts a right-justified field value and inserts it into the register.

All of the FGET type of macros return the right-justified field value and all of the FSET type of macros take a right-justified field value as an argument. The FMK and RMK macros also deal with right-justified field values.

28.3.2 `_OF` Macros

The HAL defines a set of **value-of** macros for registers and fields:

```
<PER>_<REG>_OF(x)
<PER>_<REG>_<FIELD>_OF(x)
```

These macros serve the following two purposes:

- They typecast the argument
- They make code readable

Typecasting the Argument

The macros do nothing more than return the original argument but with a typecast.

```
#define <PER>_<REG>_OF(x)    ((Uint32)(x))
```

So, you could pass just about anything as an argument and it will get typecasted into a Uint32.

Making Code More Readable

The second purpose of these macros is to make code more readable. When you are assigning a value to a register or field, it may not be clear what you are assigning to. However, if you enclose the value with an `_OF()` macro, then it becomes perfectly clear what the value is.

Consider the following example where a DMA configuration structure is being statically initialized with hard-coded values. You can see from the example that it is not very clear what the values mean.

```
/* create a config structure using hard coded values */
DMA_Config cfg = {
    0x10002050,
    0x00000080,
    (Uint32)buffa,
    (Uint32)buffb,
    0x00010008
};
```

However, using the `_OF()` macros, the code now becomes clear. The above code and the below code both do the same thing. Also notice that the `_OF()` macros help out by eliminating the need to do manual typecasts.

```
/* create a config structure using the _OF() macros */
DMA_Config cfg = {
    DMA_PRICTL_OF(0x10002050),
    DMA_SECCTL_OF(0x00000080),
    DMA_SRC_OF(buffa),
    DMA_DST_OF(buffb),
    DMA_XFRCNT_OF(0x00010008)
};
```

Every register has an _OF() macro:

- DMA_PRICTL_OF(x)
- DMA_AUXCTL_OF(x)
- MCBSP_SPCR_OF(x)
- TIMER_PRD_OF(x)
- etc...

The same principle applies for field values. Every field has an _OF() macro defined for it:

- DMA_PRICTL_ESIZE_OF(x)
- DMA_PRICTL_PRI_OF(x)
- DMA_AUXCTL_CHPRI_OF(x)
- MCBSP_SPCR_DLB_OF(x)
- etc...

The field _OF() macros are generally used with the RMK macros. However, they are also useful when a field is very wide and it is not practical to #define a symbol for every value the field could take on.

28.3.3 RMK Macros

This set of macros allows you to create or make a value suitable for a particular register by specifying its individual field values. It basically shifts and masks all of the field values then ORs them together bit-wise to form a value. No writes are actually performed, only a value is returned.

The RMK macros take an argument for each writable field and they are passed in the order of most significant field first down to the least-significant field.

```
<PER>_<REG>_RMK(field_ms,...,field_ls)
```

For illustrative purposes, we will pick a register that does not have too many fields, such as the MCBSP multichannel control register, or MCR. Here is the MCR register comment header pulled directly from the MCBSP HAL file:

```

/*****\
*
* _____
* |           |
* |   M C R   |
* |_____   |
*
*
* MCR0 - serial port 0 multichannel control register
* MCR1 - serial port 1 multichannel control register
* MCR2 - serial port 2 multichannel control register (1)
*
* (1) only supported on devices with three serial ports
*
* FIELDS (msb -> lsb)
* (rw) XPBBLK
* (rw) XPABLK
* (r)  XCBLK
* (rw) XMCM
* (rw) RPBBLK
* (rw) RPABLK
* (r)  RCBLK
* (rw) RMCM
*
\*****/

```

Out of the eight fields, only six are writable; hence, the RMK macro takes six arguments.

```
MCBSP_MCR_RMK(xpbblk, xpablk, xmcm, rpbblk, rpablk, rmcm)
```

This macro will take each of the field values `xpbblk` to `rmcm` and form a 32-bit value. There are several ways you could use this macro each with a differing level of readability.

You could just hardcode the field values

```
x = MCBSP_MCR_RMK(1, 0, 0, 1, 0, 1);
```

Or you could use the field value symbols

```
x = MCBSP_MCR_RMK(
    MCBSP_MCR_XPBBLK_SF1,
    MCBSP_MCR_XPABLK_SF0,
    MCBSP_MCR_XMCM_DISXP,
    MCBSP_MCR_RPBBLK_SF3,
    MCBSP_MCR_RPABLK_SF0,
    MCBSP_MCR_RMCM_CHENABLE
);
```

As you can see, the second method is much easier to understand and, in the long run, will be much easier to maintain.

Another consideration is when you use a variable for one of the field value arguments. Let's say that the `XMCM` argument is based on a variable in your program.

Just like before, but with the variable

```
x = MCBSP_MCR_RMK(
    MCBSP_MCR_XPBBLK_SF1,
    MCBSP_MCR_XPABLK_SF0,
    myVar,
    MCBSP_MCR_RPBBLK_SF3,
    MCBSP_MCR_RPABLK_SF0,
    MCBSP_MCR_RMCM_CHENABLE
);
```

Now use the field `_OF()` macro

```
x = MCBSP_MCR_RMK(
    MCBSP_MCR_XPBBLK_SF1,
    MCBSP_MCR_XPABLK_SF0,
    MCBSP_MCR_XMCM_OF(myVar),
    MCBSP_MCR_RPBBLK_SF3,
    MCBSP_MCR_RPABLK_SF0,
    MCBSP_MCR_RMCM_CHENABLE
);
```

In the first method, it's a little unclear what `myVar` is; however, in the second method, it's very clear because of the `_OF()` macro.

One thing that needs to be re-emphasized is the fact that the RMK macros do not write to anything; they simply return a value. As a matter of fact, if you used all symbolic constants for the field values, then the whole macro resolves down to a single integer from the compilers standpoint. The RMK macros may be used anywhere in your code, in static initializers, function arguments, arguments to other macros, etc.

28.3.4 Macro Token Pasting

The HAL macros rely heavily on token pasting, a feature of the C language. Basically, the argument of a macro is used to form identifiers.

For example, consider:

```
#define MYMAC(ARG) MYMAC##ARG##()
```

If you call MYMAC(0), then it resolves into MYMAC0() which can be a totally different macro definition.

The HAL uses this in many instances.

```
#define DMA_RGET(REG) _PER_RGET(_DMA_##REG##_ADDR, DMA,  
REG)
```

Where,

```
#define _PER_RGET(addr, PER, REG) (*(volatileUint32*)(addr))
```

Because of this token pasting, there is the possibility of side effects if you define macros that match the token names.

28.3.5 Peripheral Register Data Sheet

It is beyond the scope of this document to list every register name and every bit-field name. Instead, it is anticipated that you will have all applicable supplemental documentation available when working with this user's guide.

One option is to look inside the HAL header files where it is fairly easy to determine the register names, field names, and field values.

<PER>_ADDR

28.4 HAL Macro Reference

<PER>_ADDR	<i>Register Address</i>
Macro	<PER>_ADDR(<REG>)
Arguments	<REG> Register name
Return Value	Uint32 Address
Description	Returns the address of a memory mapped register. <PER> is a placeholder for the peripheral name: DMA, MCBSP, TIMER, etc.
Example	<pre>Uint32 regAddr; regAddr = DMA_ADDR(PRICTL0); regAddr = DMA_ADDR(AUXCTL); regAddr = MCBSP_ADDR(SPCR0);</pre>

<PER>_ADDRH	<i>Register Address for a Given Handle</i>
Macro	<PER>_ADDRH(h,<REG>)
Arguments	h Peripheral handle <REG> Register name
Return Value	Uint32 Address
Description	Returns the address of the memory-mapped register given a handle. Only registers covered by the handle structure are valid, if any. <PER> is a placeholder for the peripheral name: DMA, MCBSP, TIMER, etc.
Example	<pre>DMA_Handle hDma; Uint32 regAddr; hDma = DMA_open(DMA_CHA2, 0); regAddr = DMA_ADDRH(hDma, PRICTL); regAddr = DMA_ADDRH(hDma, SRC);</pre>

<PER>_CRGET	<i>Gets the Value of CPU Register</i>
Macro	<PER>_CRGET(<REG>)
Arguments	<REG> CPU register name (i.e. CSL, IER, ISR...)
Return Value	Uint32 Register value
Description	Returns the current value of a CPU register. The value returned is right-justified. <PER> is a placeholder for the peripheral name (applies to CHIP module only).
Example	<pre>Uint32 valReg; valReg = CHIP_CRGET(CSR);</pre>

<PER>_CRSET *Sets the Value of CPU Register*

Macro	<code><PER>_CRSET(<REG>)</code>
Arguments	<code><REG></code> CPU register name (i.e. CSL, IER, ISR...) <code>x</code> Uint 32 value to set the register
Return Value	none
Description	Writes the value <code>x</code> into the CPU <code><REG></code> register. <code>x</code> may be any valid C expression. <code><PER></code> is a placeholder for the peripheral name (applies to CHIP module only).
Example	<pre>/* set the IER register */ CHIP_CRSET(IER, 0x00010001);</pre>

<PER>_FGET *Gets a Field Value From a Register*

Macro	<code><PER>_FGET(<REG>,<FIELD>)</code>
Arguments	<code><REG></code> Register name <code><FIELD></code> Field name
Return Value	Uint32 Field value, right-justified
Description	Returns a field value from a register. The value returned is right-justified. <code><PER></code> is a placeholder for the peripheral name: DMA, MCBSP, TIMER, etc.
Example	<pre>Uint32 fieldVal; fieldVal = DMA_FGET(PRICTL0, INDEX); fieldVal = DMA_FGET(AUXCTL, CHPRI); fieldVal = MCBSP_FGET(SPCR0, XRDY);</pre>

<PER>_FGETA *Gets Field for a Given Address*

Macro	<code><PER>_FGETA(addr,<REG>,<FIELD>)</code>
Arguments	<code>addr</code> Uint32 address <code><REG></code> Register name <code><FIELD></code> Field name
Return Value	Uint32 Field value, right-justified
Description	Returns the value of the field given the address of the memory mapped register. The return value is right-justified. This macro is useful in those situations where an arbitrary memory location is treated like a register such as in a configuration structure. <code><PER></code> is a placeholder for the peripheral name: DMA, MCBSP, TIMER, etc.

<PER>_FGETH

Example

```
Uint32 fieldVal;
    Uint32 regAddr = 0x01840000;
    DMA_Config cfg;
    fieldVal = DMA_FGETA(0x01840000, PRICTL, INDEX);
    fieldVal = DMA_FGETA(regAddr, PRICTL, PRI);
    fieldVal = DMA_FGETA(0x01840070, AUXCTL, CHPRI);
    fieldVal = DMA_FGETA(&(cfg.prictl), PRICTL, EMOD);
```

<PER>_FGETH

Gets Field for a Given Handle

Macro

<PER>_FGETH(h,<REG>,<FIELD>)

Arguments

h Peripheral handle
<REG> Register name
<FIELD> Field name

Return Value

Uint32 Field value, right-justified

Description

Returns the value of the field given a handle. Only registers covered by handles per peripheral are valid, if any. <PER> is a placeholder for the peripheral name: DMA, MCBSP, TIMER, etc.

Example

```
DMA_Handle hDma;
    Uint32 fieldVal;
    hDma = DMA_open(DMA_CHA1, 0);
    fieldVal = DMA_FGETH(hDma, PRICTL , ESIZE);
```

<PER>_FMK

Field Make

Macro

<PER>_FMK(<REG>,<FIELD>,x)

Arguments

<REG> Register name
<FIELD> Field name
x Field value, right-justified

Return Value

Uint32 In-place and masked-field value

Description

This macro takes the right-justified field value then shifts it over and masks it to form the in-place field value. It can be bit-wise OR'ed with other FMK or FMKS macros to form a register value as an alternative to the RMK macro.

Example

```
Uint32 x;
    x = DMA_FMK(AUXCTL, CHPRI, 0)
      | DMA_FMK(AUXCTL, AUXPRI, 0);
```

<PER>_FMKS *Field Make Symbolically*

Macro	<PER>_FMKS(<REG>,<FIELD>,<SYM>)
Arguments	<REG> Register name <FIELD> Field name <SYM> Symbolic field value
Return Value	UInt32 In-place and masked-field value
Description	This macro takes the symbolic field value then shifts it over and masks it to form the in-place field value. It can be bit-wise OR'ed with other FMK or FMKS macros to form a register value as an alternative to the RMK macro.
Example	<pre>UInt32 x; x = DMA_FMKS(AUXCTL, CHPRI, HIGHEST) DMA_FMKS(AUXCTL, AUXPRI, CPU);</pre>

<PER>_FSET *Field Set*

Macro	<PER>_FSET(<REG>,<FIELD>,x)
Arguments	<REG> Register name <FIELD> Field name x UInt32 right-justified field value
Return Value	none
Description	Sets a field of a register to the specified value. The value is right-justified. <PER> is a placeholder for the peripheral name: DMA, MCBSP, TIMER, etc.
Example	<pre>UInt32 fieldVal = 0; DMA_FSET(PRCTL0, INDEX, 0); DMA_FSET(PRCTL0, INDEX, fieldVal); DMA_FSET(AUXCTL, CHPRI, 1); TIMER_FSET(CTL0, GO, 0);</pre>

<PER>_FSETA

<PER>_FSETA *Sets Field for a Given Address*

Macro	<PER>_FSETA(addr,<REG>,<FIELD>,x)
Arguments	addr Uint32 address <REG> Register name <FIELD> Field name x Uint32 field value, right-justified
Return Value	none
Description	Sets the field value to <i>x</i> where <i>x</i> is right-justified. This macro is useful in those situations where an arbitrary memory location is treated like a register such as in a configuration structure. <PER> is a placeholder for the peripheral name: DMA, MCBSP, TIMER, etc.

Example

```
Uint32 fieldVal = 0;
    Uint32 regAddr = 0x01840000;
    DMA_FSETA(0x01840000, PRICTL ,INDEX, 0);
    DMA_FSETA(regAddr, PRICTL, INDEX, fieldVal);
    DMA_FSETA(0x01840000, PRICTL, INDEX, fieldVal);
    MCBSP_FSETA(0x018C0008, SPCR, DLB, 0);
    Uint32 dummyReg = DMA_PRICTL_DEFAULT;
    DMA_FSETA(&dummyReg, PRICTL, EMOD, 1);
```

<PER>_FSETH *Sets Field for a Given Handle*

Macro	<PER>_FSETH(h,<REG>,<FIELD>,x)
Arguments	h Peripheral handle <REG> Register name <FIELD> Field name x Uint32 field value, right-justified
Return Value	none
Description	Sets the field value to <i>x</i> given a handle. Only registers covered by handles per peripheral are valid, if any. <PER> is a placeholder for the peripheral name: DMA, MCBSP, TIMER, etc.

Example

```
DMA_Handle hDma;
    hDma = DMA_open(DMA_CHA2, DMA_OPEN_RESET);
    DMA_FSETH(hDma, PRICTL, ESIZE, 3);
```

<PER>_FSETS *Sets a Field Symbolically*

Macro	<code><PER>_FSETS(<REG>,<FIELD>,<SYM>)</code>
Arguments	<code><REG></code> Register name <code><FIELD></code> Field name <code><SYM></code> Symbolic value name
Return Value	none
Description	Sets a register field to the specified symbol value. The value <i>MUST</i> be one of the predefined symbolic names for that field for that register. <code><PER></code> is a placeholder for the peripheral name: DMA, MCBSP, TIMER, etc.
Example	<pre>DMA_FSETS(PRICTL0, INDEX, A); DMA_FSETS(AUXCTL, CHPRI, HIGHEST); MCBSP_FSETS(SPCR0, DLB, OFF); MCBSP_FSETS(SPCR1, DLB, DEFAULT);</pre>

<PER>_FSETSA *Sets Field Symbolically for a Given Address*

Macro	<code><PER>_FSETSA(addr,<REG>,<FIELD>,<SYM>)</code>
Arguments	<code>addr</code> Uint32 address <code><REG></code> Register name <code><FIELD></code> Field name <code><SYM></code> Field value name
Return Value	none
Description	Sets a register field to the specified value. The value <i>MUST</i> be one of the predefined symbolic names for that field in that register. This macro is useful in those situations where an arbitrary memory location is treated like a register such as in a configuration structure. <code><PER></code> is a placeholder for the peripheral name: DMA, MCBSP, TIMER, etc.
Example	<pre>Uint32 regAddr = 0x01840000; DMA_FSETSA(0x01840000, PRICTL, INDEX, A); DMA_FSETSA(regAddr, PRICTL, INDEX, B); DMA_FSETSA(0x01840000, PRICTL, INDEX, A); MCBSP_FSETSA(0x018C0008, SPCR, DLB, OFF); Uint32 dummyReg = DMA_PRICTL_DEFAULT; DMA_FSETSA(&dummyReg, PRICTL, EMOD, HALT);</pre>

<PER>_FSETSH

<PER>_FSETSH *Sets Field Symbolically for a Given Handle*

Macro	<PER>_FSETSH(h,<REG>,<FIELD>,<SYM>)
Arguments	h Peripheral handle <REG> Register name <FIELD> Field name <SYM> Symbolic field value
Return Value	none
Description	Sets a register field to the specified value given a handle. The value <i>MUST</i> be one of the predefined symbolic names for that field in that register. Only registers covered by handles per peripheral are valid, if any. <PER> is a placeholder for the peripheral name: DMA, MCBSP, TIMER, etc.

Example

```
DMA_Handle hDma;  
    hDma = DMA_open(DMA_CHA0, DMA_OPEN_RESET);  
    DMA_FSETSH(hDma, PRICTL, ESIZE, 32BIT);
```

<PER>_RGET *Gets Register Current Value*

Macro	<PER>_RGET(<REG>)
Arguments	<REG> Register name
Return Value	UInt32 Register value
Description	Returns the current value of a register. <PER> is a placeholder for the peripheral name: DMA, MCBSP, TIMER, etc.

Example

```
UInt32 regVal;  
    regVal = DMA_RGET(PRICTL0);  
    regVal = MCBSP_RGET(SPCR0);  
    regVal = DMA_RGET(AUXCTL);  
    regVal = TIMER_RGET(CTL0);
```

<PER>_RGETA *Gets Register Address*

Macro	<code><PER>_RGETA(addr,<REG>)</code>	
Arguments	<code>addr</code>	Uint32 address
	<code><REG></code>	Register name
Return Value	Uint32	Register value
Description	Returns the current value of a register given the address of the register. This macro is useful in those situations where an arbitrary memory location is treated like a register such as in a configuration structure. <PER> is a placeholder for the peripheral name: DMA, MCBSP, TIMER, etc.	

Example

```
Uint32 regVal;
DMA_Config cfg;
regVal = DMA_RGETA(0x01840000, PRICTL);
regVal = DMA_RGETA(0x01840070, AUXCTL);
regVal = DMA_RGETA(&(cfg.prictl), PRICTL);
```

<PER>_RGETH *Gets Register for a Given Handle*

Macro	<code><PER>_RGETH(h,<REG>)</code>	
Arguments	<code>h</code>	Peripheral handle
	<code><REG></code>	Register name
Return Value	Uint32	Uint32 register value
Description	Returns the value of a register given a handle. Only registers covered by the handle structure are valid, if any. <PER> is a placeholder for the peripheral name: DMA, MCBSP, TIMER, etc.	

Example

```
DMA_Handle hDma;
Uint32 regVal;
hDma = DMA_open(DMA_CHA2, DMA_OPEN_RESET);
regVal = DMA_RGETH(hDma, PRICTL);
```

<PER>_RSET

<PER>_RSET

Register Set

Macro	<PER>_RSET(<REG>,x)
Arguments	<REG> Register name x Uint32 value to set register to
Return Value	none
Description	Write the value <i>x</i> to the register. <i>x</i> may be any valid C expression. <PER> is a placeholder for the peripheral name: DMA, MCBSP, TIMER, etc.
Example	<pre>Uint32 regVal = 0x09000101; DMA_RSET(PRICTL0, 0x09000101); DMA_RSET(PRICTL0, regVal); DMA_RSET(AUXCTL, DMA_AUXCTL_DEFAULT); MCBSP_RSET(SPCR0, 0x00000000); DMA_RSET(PRICTL0, DMA_RGET(PRICTL0)&0xFFFFFFFFC);</pre>

<PER>_RSETA

Sets Register for a Given Address

Macro	<PER>_RSETA(addr,<REG>,x)
Arguments	addr Uint32 address <REG> Register name x Uint32 register value
Return Value	none
Description	Sets the value of a register given its address. This macro is useful in those situations where an arbitrary memory location is treated like a register such as in a configuration structure. <PER> is a placeholder for the peripheral name: DMA, MCBSP, TIMER, etc.
Example	<pre>Uint32 regVal = 0x09000101; DMA_Config cfg; DMA_RSETA(0x01840000, PRICTL, 0x09000101); DMA_RSETA(0x01840000, PRICTL, regVal); DMA_RSETA(0x01840070, AUXCTL, 0); DMA_RSETA(&(cfg.secctl), SECCTL, 0);</pre>

<PER>_RSETH *Sets Register for a Given Handle*

Macro	<code><PER>_RSETH(h,<REG>,x)</code>	
Arguments	<code>h</code>	Peripheral handle
	<code><REG></code>	Register name
	<code>x</code>	Uint32 register value
Return Value	none	
Description	Sets the register value to <code>x</code> given a handle. Only registers covered by handles per peripheral are valid, if any. <code><PER></code> is a placeholder for the peripheral name: DMA, MCBSP, TIMER, etc.	
Example	<pre>DMA_Handle hDma; hDma = DMA_open(DMA_CHA0, DMA_OPEN_RESET); DMA_RSETH(hDma, PRICTL, 0x09000101); DMA_RSETH(hDma, SECCTL, 0x00000080);</pre>	

<PER>_<REG>_DEFAULT *Register Default Value*

Macro	<code><PER>_<REG>_DEFAULT</code>	
Arguments	none	
Return Value	Uint32	Register default value
Description	Returns the default (power-on) value for the specified register.	
Example	<pre>Uint32 defRegVal;; defRegVal = DMA_AUXCTL_DEFAULT; defRegVal = DMA_PRICTL_DEFAULT; defRegVal = EMIF_GBLCTL_DEFAULT;</pre>	

<PER>_<REG>_OF

<PER>_<REG>_OF *Returns Value Of*

Macro	<PER>_<REG>_OF(x)
Arguments	x Register value
Return Value	Uint32 Returns x casted into a Uint32

Description This macro simply takes the argument *x* and returns it. It is type-casted into a Uint32. The intent is to make code more readable. The examples illustrate this: Example 1 does not use these macros and Example 2 does. Notice how Example 2 is easier to follow. You are not required to use these macros; however, they can be helpful.

Example 1

```
/* create a config structure using hard coded values */
DMA_Config cfg = {
    0x10002050,
    0x00000080,
    (Uint32)buffa,
    (Uint32)buffb,
    0x00010008
};
```

Example 2

```
/* create a config structure using the OF macros */
DMA_Config cfg = {
    DMA_PRICTL_OF(0x10002050),
    DMA_SECCTL_OF(0x00000080),
    DMA_SRC_OF(buffa),
    DMA_DST_OF(buffb),
    DMA_XFRCNT_OF(0x00010008)
};
```

<PER>_<REG>_RMK *Register Make*

Macro	<PER>_<REG>_RMK(field_ms,...,field_ls)
Arguments	field_ms Most-significant field value, right-justified ... Intermediate-field values, right-justified field_ls Least-significant field value, right-justified
Return Value	UInt32 Value suitable for this register
Description	<p>This macro constructs (makes) a register value based on individual field values. It does not do any writes; it just returns a value suitable for this register. Use this macro to make your code readable.</p> <p>Only writable fields are specified and they are ordered from most significant to least significant. Also, note that this macro may vary from one device to another for the same register.</p>

Example

```
UInt32 prictl;  
prictl = DMA_PRICTL_RMK(  
    DMA_PRICTL_DSTRLD_NONE,  
    DMA_PRICTL_SRCRLD_NONE,  
    DMA_PRICTL_EMOD_HALT,  
    DMA_PRICTL_FS_DISABLE,  
    DMA_PRICTL_TCINT_DISABLE,  
    DMA_PRICTL_PRI_CPU,  
    DMA_PRICTL_WSYNC_NONE,  
    DMA_PRICTL_RSYNC_NONE,  
    DMA_PRICTL_INDEX_DEFAULT,  
    DMA_PRICTL_CNTRLD_DEFAULT,  
    DMA_PRICTL_SPLIT_DISABLE,  
    DMA_PRICTL_ESIZE_32BIT,  
    DMA_PRICTL_DSTDIR_INC,  
    DMA_PRICTL_SRCDIR_INC,  
    DMA_PRICTL_START_NORMAL  
);
```

<PER>_<REG>_<FIELD>_DEFAULT

<PER>_<REG>_<FIELD>_DEFAULT *Field Default Value*

Macro	<code><PER>_<REG>_<FIELD>_DEFAULT</code>
Arguments	none
Return Value	UInt32 Register default value
Description	Returns the default (power-on) value for the specified field.
Example	<pre>UInt32 defFieldVal;; defRegVal = DMA_AUXCTLCHPRI_DEFAULT; defRegVal = DMA_PRICTLESIZE_DEFAULT;</pre>

<PER>_<REG>_<FIELD>_OF *Field Value Of*

Macro	<code><PER>_<REG>_<FIELD>_OF(x)</code>
Arguments	x Field value, right-justified
Return Value	UInt32 Returns x casted into a UInt32
Description	This macro simply takes the argument x and returns it. It is type-casted into a UInt32. The intent is to make code more readable. It serves a similar purpose to the <code><PER>_<REG>_OF()</code> macros. Generally, these macros are used in conjunction with the <code><PER>_RMK(...)</code> macros. You are not required to use these macros; however, they can be helpful.
Example	<pre>UInt32 idx; idx = DMA_PRICTL_INDEX_OF(1);</pre>

<PER>_<REG>_<FIELD>_<SYM> *Field Symbolic Value*

Macro	<code><PER>_<REG>_<FIELD>_<SYM></code>
Arguments	none
Return Value	UInt32 field value
Description	Sets the specified value to the bit field
Example	<pre>MCBSP_SRGR_RMK (MCBSP_SRGR_GSYNC_FREE, MCBSP_SRGR_CLKSP_RISING, MCBSP_SRGR_CLKSM_INTERNAL, MCBSP_SRGR_FSGM_DXR2XSR, MCBSP_SRGR_FPER_OF(63), MCBSP_SRGR_FWID_OF(31), MCBSP_SRGR_CLKGDV_OF(15)),</pre>

Using CSL APIs Without DSP/BIOS ConfigTool

You are not required to use the DSP/BIOS Configuration Tool when working with the CSL library. As GUI-based configuration of the CSL is getting deprecated, it is recommended to avoid its usage.

Note:
You can continue to use the CDB file in your application but only for configuring CSL peripherals; you can choose not to use CSL GUI in the CDB file.

For 6713 and DA610 CSL, the GUI configuration supports only the peripherals already supported in GUI for 6711.

This appendix provides an example of using CSL independently of the DSP/BIOS kernel.

Topic	Page
A.1 Using CSL APIs	A-2
A.2 Compiling/Linking With CSL Using Code Composer Studio IDE ..	A-7

A.1 Using CSL APIs

Example A-1 illustrates the use of CSL to initialize DMA channel 0 and copy table BuffA to another table BuffB of 1024 bytes (1024/4 elements).

A.1.1 Using DMA_config()

Example A-1 uses the DMA_config() function to initialize the registers.

Example A-1. Initializing a DMA Channel with DMA_config()

```
// Step 1:  Include the generic csl.h include file and
//          the header file of the module/peripheral you
//          will use. The different header files are shown
//          in Table 1-1, CSL Modules and Include Files, on page 1-3.
//          The order of inclusion does not matter.

#include <csl.h>
#include <csl_dma.h>

// Example-specific initialization
#define BUFFSZ 1024

#define Uint32 BuffA[BUFFSZ/sizeof(Uint32)]
#define Uint32 BuffB[BUFFSZ/sizeof(Uint32)]

//Step 2:  Define and initialize the DMA channel
//          configuration structure.
```

```

DMA_Config myconfig = {
    /* DMA_PRICTL */
    DMA_PRICTL_RMK(
        DMA_PRICTL_DSTRLD_NONE,
        DMA_PRICTL_SRCRLD_NONE,
        DMA_PRICTL_EMOD_NOHALT,
        DMA_PRICTL_FS_DISABLE,
        DMA_PRICTL_TCINT_DISABLE,
        DMA_PRICTL_PRI_DMA,
        DMA_PRICTL_WSYNC_NONE,
        DMA_PRICTL_RSYNC_NONE,
        DMA_PRICTL_INDEX_NA,
        DMA_PRICTL_CNTRLD_NA,
        DMA_PRICTL_SPLIT_DISABLE,
        DMA_PRICTL_ESIZE_32BIT,
        DMA_PRICTL_DSTDIR_INC,
        DMA_PRICTL_SRCDIR_INC,
        DMA_PRICTL_STATUS_STOPPED,
        DMA_PRICTL_START_NORMAL,
    ),

    /* DMA_SECCTL */
    DMA_SECCTL_RMK(
        DMA_SECCTL_WSPOL_NA,
        DMA_SECCTL_RSPOL_NA,
        DMA_SECCTL_FSIG_NA,
        DMA_SECCTL_DMACEN_LOW,
        DMA_SECCTL_WSYNCCLR_NOTHING,
        DMA_SECCTL_WSYNCSTAT_CLEAR,
        DMA_SECCTL_RSYNCCLR_NOTHING,
        DMA_SECCTL_RSYNCSTAT_CLEAR,
        DMA_SECCTL_WDROPIE_DISABLE,
        DMA_SECCTL_WDROPCOND_CLEAR,
        DMA_SECCTL_RDROPIE_DISABLE,
        DMA_SECCTL_RDROPCOND_CLEAR,
        DMA_SECCTL_BLOCKIE_ENABLE,
        DMA_SECCTL_BLOCKCOND_CLEAR,
        DMA_SECCTL_LASTIE_DISABLE,
        DMA_SECCTL_LASTCOND_CLEAR,
        DMA_SECCTL_FRAMEIE_DISABLE,
        DMA_SECCTL_FRAMECOND_CLEAR,
        DMA_SECCTL_SXIE_DISABLE,
        DMA_SECCTL_SXCOND_CLEAR,
    ),

    /* src */
    (Uint32) BuffA,

    /* dst */
    (Uint32) BuffB,

    /* xfrcnt */
    BUFSIZE/sizeof(Uint32)
};

```

Example A-1. Initializing a DMA Channel with DMA_config() (Continued)

```

//Step 3:   Define a DMA_Handle pointer. DMA_open returns
//          a pointer to a DMA_Handle when a DMA channel is
//          opened.

DMA_Handle myhDma;

void main(void) {
// Initialize Buffer tables
    for (x=0;x<BUFFSZ/sizeof(Uint32);x++) {
        BuffA[x]=x;
        BuffB[x]=0;
    }

//Step 4:   One-time only initialization of the CSL library
//          and of the CSL module to be used. Must be done
//          before calling any CSL module API.

    CSL_init();                /* Init CSL      */

//Step 5:   Open, configure and start the DMA channel.
//          To configure the channel you can use the
//          DMA_config or DMA_configArgs functions.

    myhDma = DMA_open(DMA_CHA0,0); /*Open Channel(Optional) */
    DMA_config(myhDma, &myconfig); /* Configure Channel */
    DMA_start(myhDma);           /* Begin Transfer   */

//Step 6:   (Optional)
//          Use CSL DMA APIs to track DMA channel status.

    while(DMA_getStatus(myhDma)); /* Wait for complete */

//Step 7:   Close DMA channel after using.

    DMA_close(myhDma);         /* Close channel (Optional) */
}

```

Note:

The usage of the RMK macro for configuring registers is recommended as shown above in Step 2. This is because it is using symbolic constants provided by CSL for setting fields of the register.

Refer to Table 1-5 for further help on the RMK macro. Also refer to Appendix B for the symbolic constants provided by CSL for registers and bit-fields of any peripherals.

A.1.2 Using DMA_configArgs()

Example A-2 performs the same task as Example A-1 but uses DMA_configArgs() to initialize the registers.

Example A-2. Initializing a DMA Channel with DMA_configArgs()

```

// Step 1:   Include the generic cs1.h include file and
//           the header file of the module/peripheral you
//           will use. The different header files are shown
//           in Table 1-1, CSL Modules and Include Files, on page 1-3.
//           The order of inclusion does not matter.

#include <cs1.h>
#include <cs1_dma.h>

// Example-specific initialization
#define BUFFSZ 1024

#define Uint32 BuffA[BUFFSZ/sizeof(Uint32)]
#define Uint32 BuffB[BUFFSZ/sizeof(Uint32)]

//Step 2:   Define a DMA_Handle pointer. DMA_open returns
//           a pointer to a DMA_Handle when a DMA channel is
//           opened.

DMA_Handle myhDma;
void main(void) {
// Initialize Buffer tables
    for (x=0;x<BUFFSZ/sizeof(Uint32);x++) {
        BuffA[x]=x;
        BuffB[x]=0;
    }

//Step 3:   One-time only initialization of the CSL library
//           and of the CSL module to be used. Must be done
//           before calling any CSL module API.

    CSL_init();                               /* Init CSL      */

//Step 4:   Open, configure, and start the DMA channel.
//           To configure the channel you can use the
//           DMA_config() or DMA_configArgs() functions.

```

Example A-2. Initializing a DMA Channel with DMA_configArgs() (Continued)

```
myhDma = DMA_open(DMA_CHA0,0); /*Open Channel(Optional) */
DMA_configArgs(myhDma,
    0x01000051,                /* prictl */
    0x00000080,                /* secctl */
    (Uint32) BuffA,            /* src    */
    (Uint32) BuffB,            /* dst    */
    BUFFSZ/sizeof(Uint32)      /* xfrcnt */
);
);
DMA_start(myhDma);           /* Begin Transfer */

//Step 6: (Optional)
//      Use CSL DMA APIs to track DMA channel status.

while(DMA_getStatus(myhDma)); /* Wait for complete */

//Step 7: Close DMA channel after using.

DMA_close(myhDma);          /* Close channel (Optional) */
}
```

A.2 Compiling and Linking With CSL Using Code Composer Studio IDE

A.2.1 CSL Directory Structure

Table A–1 lists the locations of the CSL components. Use this information when you set up the compiler and linker search paths.

Table A–1. CSL Directory Structure

This CSL component...	is located in this directory...
Libraries	c:\ti\c6000\bios\lib
Source library	c:\ti\c6000\bios\src
Include files	c:\ti\c6000\bios\include
Examples	c:\ti\examples\dsk6211\cs1 c:\ti\examples\levm6201\cs1
Documentation	c:\ti\docs

A.2.2 Using the Code Composer Studio Project Environment

To configure the CCS project environment to work with CSL, follow these steps to specify the target device you are using:

- 1) Select Project→Options... from the menu bar.
- 2) Select the Compiler tab in the Build Options dialog box (Figure A–1), and highlight Symbols in the category list box.
- 3) In the Define Symbols field, enter one and only one of the compiler symbols in Table 1–10, *CSL Device Support Library Name and Symbol Conventions*, on page 1-17.

For example, if you are using the 6201™ device, enter CHIP_6201.

- 4) Click OK.

Figure A-1. Defining the Target Device in the Build Options Dialog Box

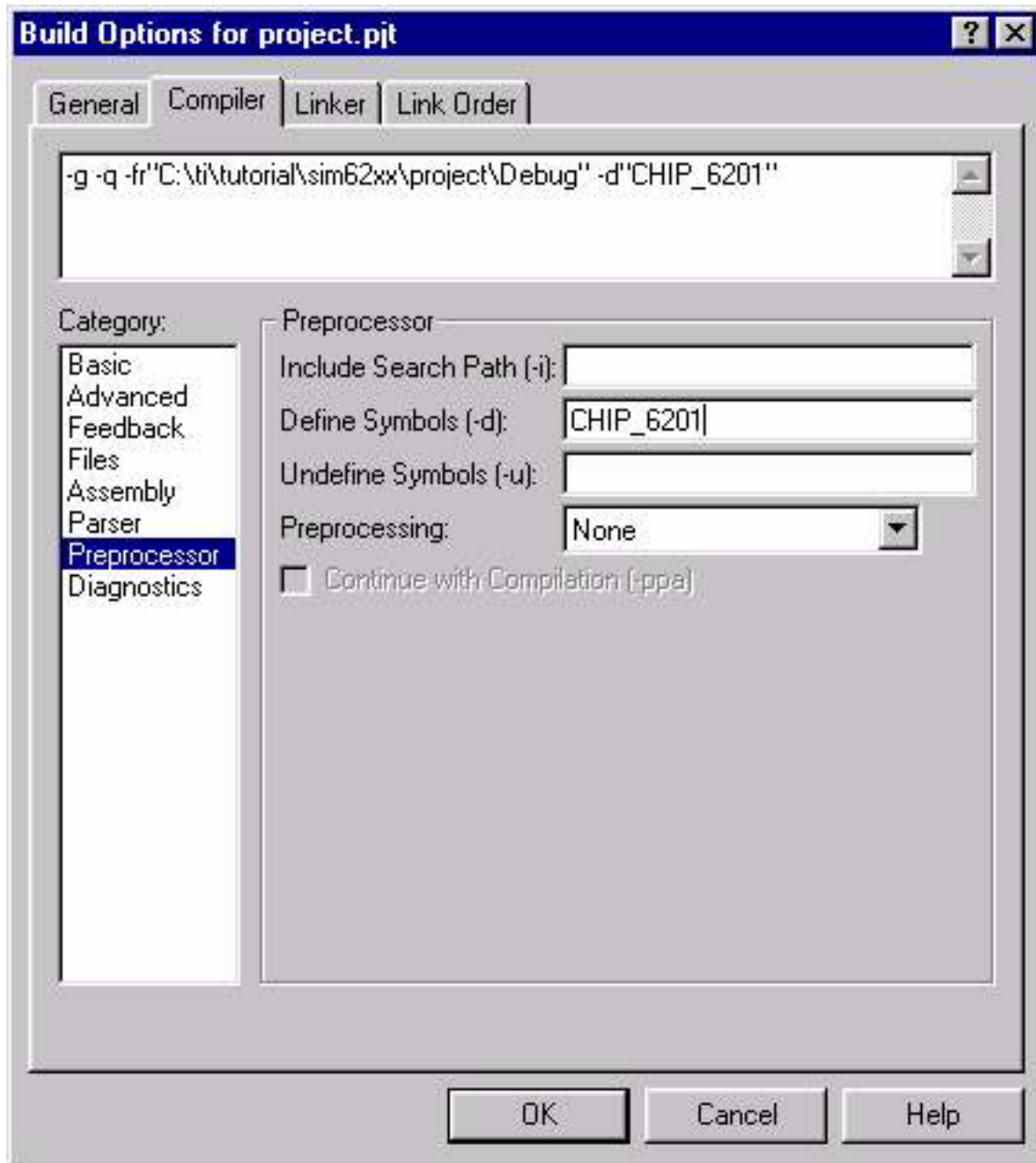

TMS320C6000 CSL Registers

This appendix shows the registers associated with current TMS320C6000 digital signal processor (DSP) devices. The individual peripheral reference guides also include the registers and may also have a list of symbolic constants. The symbolic constants and registers in the peripheral reference guides are to be used as the latest updates. For a list of peripheral reference guides for your device, see *TMS320C6000 DSP Peripherals Overview Reference Guide* (SPRU190).

Topic	Page
B.1 Cache Registers	B-2
B.2 Direct Memory Access (DMA) Registers	B-17
B.3 Enhanced DMA (EDMA) Registers	B-31
B.4 EMAC Control Module Registers	B-60
B.5 EMAC Module Registers	B-64
B.6 External Memory Interface (EMIF) Registers	B-122
B.7 General-Purpose Input/Output (GPIO) Registers	B-149
B.8 Host Port Interface (HPI) Register	B-159
B.9 Inter-Integrated Circuit (I2C) Registers	B-168
B.10 Interrupt Request (IRQ) Registers	B-203
B.11 Multichannel Audio Serial Port (McASP) Registers	B-207
B.12 Multichannel Buffered Serial Port (McBSP) Registers	B-284
B.13 MDIO Module Registers	B-311
B.14 Peripheral Component Interconnect (PCI) Registers	B-328
B.15 Phase-Locked Loop (PLL) Registers	B-353
B.16 Power-Down Control Register	B-359
B.17 TCP Registers	B-360
B.18 Timer Registers	B-382
B.19 UTOPIA Registers	B-386
B.20 VCP Registers	B-396
B.21 VIC Port Registers	B-409
B.22 Video Port Control Registers	B-413
B.23 Video Capture Registers	B-427
B.24 Video Display Registers	B-462
B.25 Video Port GPIO Registers	B-504
B.26 Expansion Bus (XBUS) Registers	B-529

B.1 Cache Registers

Table B–1. Cache Registers

Acronym	Register Name	Section
CCFG	Cache configuration register	B.1.1
EDMAWEIGHT [†]	L2 EDMA access control register	B.1.2
L2WBAR	L2 writeback base address register	B.1.3
L2WWC	L2 writeback word count	B.1.4
L2WIBAR	L2 writeback– invalidate base address register	B.1.5
L2WIWC	L2 writeback– invalidate word count	B.1.6
L2IBAR [†]	L2 invalidate base address register	B.1.7
L2IWC [†]	L2 invalidate word count	B.1.8
L2ALLOC0– L2ALLOC3 [‡]	L2 allocation priority queue registers	B.1.9
L1PIBAR	L1P invalidate base address register	B.1.10
L1PIWC	L1P invalidate word count	B.1.11
L1DWIBAR	L1D writeback– invalidate base address register	B.1.12
L1DWIWC	L1D writeback– invalidate word count	B.1.13
L1DIBAR [†]	L1D invalidate base address register	B.1.14
L1DIWC [†]	L1D invalidate word count	B.1.15
L2WB	L2 writeback all	B.1.16
L2WBINV	L2 writeback– invalidate all	B.1.17
MAR0–15 [†]	L2 memory attribute registers	B.1.18
MAR96–111 [†]	L2 memory attribute registers for EMIFB only	B.1.19
MAR128–191 [†]	L2 memory attribute registers for EMIFA only	B.1.20

Notes: 1) The names of the registers have been changed, Appendix D contains a comparison table of old versus new names.

[†] For C621x/C671x only.

[‡] For C64x only.

B.1.1 Cache Configuration Register (CCFG)

Figure B–1. Cache Configuration Register (CCFG)

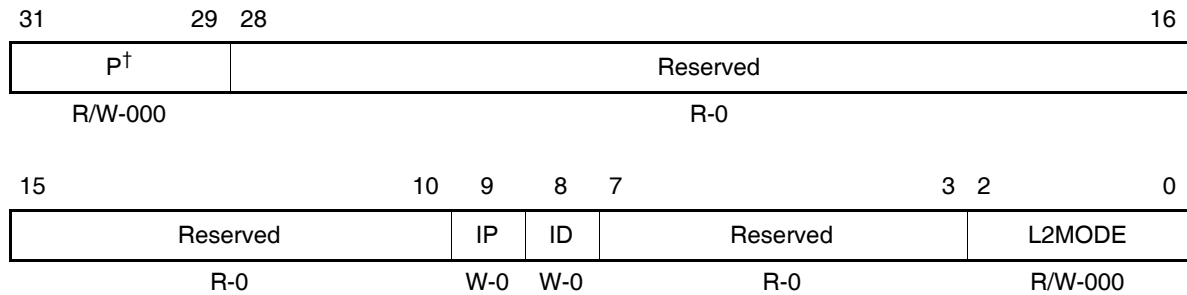

[†] Applicable on C64 only. On C621x/C671x, bit field P is Reserved, R-000b.

Legend: R/W-x = Read/Write-Reset value

Table B–2. Cache Configuration Register (CCFG) Field Values

Bit	field [†]	symval [†]	Value	Description
31–29	P			L2 Requestor Priority (for C64x only, reserved for C621x/C671x)
		URGENT	0	L2 controller requests are placed on urgent priority level
		HIGH	1h	L2 controller requests are placed on high priority level
		MEDIUM	2h	L2 controller requests are placed on medium priority level
		LOW	3h	L2 controller requests are placed on low priority level
28–10	Reserved	–	0	Reserved. The reserved bit location is always read as zero. A value written to this field has no effect.
9	IP			L1P operation
		NORMAL	0	Normal L1P operation
		INVALIDATE	1	All L1P lines invalidated
8	ID			Invalidate L1D
		NORMAL	0	Normal L1D operation
		INVALIDATE	1	All L1D lines invalidated Invalidate LIP
7–3	Reserved	–	0	Reserved. The reserved bit location is always read as zero. A value written to this field has no effect.

[†] For CSL implementation, use the notation `CACHE_CCFG_field_symval`

Table B–2. Cache Configuration Register (CCFG) Field Values (Continued)

Bit	field [†]	symval [†]	Value	Description
2–0	L2MODE			L2 Operation Mode
		0KC	0	No L2 Cache (All SRAM mode)
		16KC	1h	1-way cache (16K L2 cache) C621x/C671x only
		32KC	1h	4-way cache (32K L2 cache) C64x only
		32KC	2h	2-way cache (32K L2 cache) C621x/C671x only
		64KC	2h	4-way cache (64K L2 cache) C64x only
		48KC	3h	3-way cache (48K L2 cache) C621x/C671x only
		128KC	3h	4-way cache (128K L2 cache) C64x only
		–	4h–6h	Reserved
		64KC	7h	4-way cache (64K L2 cache) C621x/C671x only
		256KC	7h	4-way cache (256K L2 cache) C64x only

[†] For CSL implementation, use the notation `CACHE_CCFG_field_symval`

B.1.2 L2 EDMA Access Control Register (C64x)

Figure B–2. L2 EDMA Access Control Register (EDMAWEIGHT)

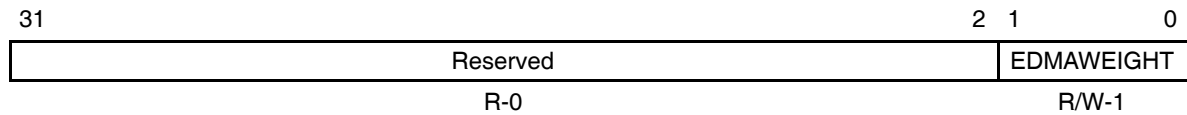

Legend: R = Read only; R/W = Read/Write; -n = value after reset

Table B–3. L2 EDMA Access Control Register (EDMAWEIGHT) Field Values

Bit	Field	Value	Description
31–2	Reserved	0	Reserved. The reserved bit location is always read as zero. A value written to this field has no effect.
1–0	EDMAWEIGHT	0	L1D access always a higher priority than EDMA access to L2. EDMA never receives priority.
		1h	EDMA receives priority after 16 L1D priority cycles.
		2h	EDMA receives priority after 4 L1D priority cycles.
		3h	EDMA receives priority after 1 L1D priority cycle.

B.1.3 L2 Writeback Base Address Register (L2WBAR)

Figure B–3. L2 Writeback Base Address Register (L2WBAR)

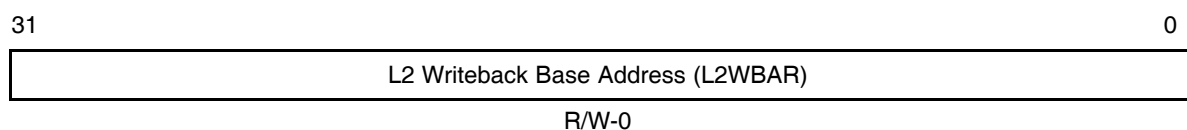

Legend: R/W-x = Read/Write-Reset value

Table B–4. L2 Writeback Base Address Register (L2WBAR) Field Values

Bit	field [†]	symval [†]	Value	Description
31–0	LWFBAR	OF(value)	0–FFFF FFFFh	L2 Writeback Base Address.

[†] For CSL implementation, use the notation `CACHE_L2WBAR_field_symval`

B.1.4 L2 Writeback Word Count Register (L2WWC)

Figure B–4. L2 Writeback Word Count Register (L2WWC)

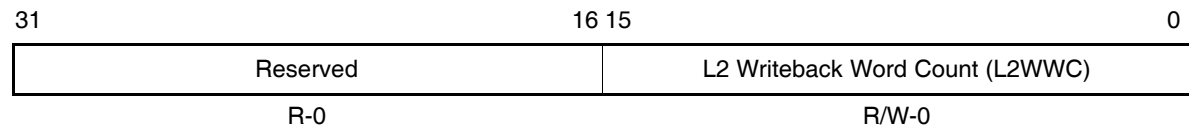

Legend: R/W-x = Read/Write-Reset value

Table B–5. L2 Writeback Word Count Register (L2WWC) Field Values

Bit	field [†]	symval [†]	Value	Description
31–16	Reserved	–	0	Reserved. The reserved bit location is always read as zero. A value written to this field has no effect.
15–0	L2WWC	OF(value)	0–FFFFh	L2 Writeback Word Count.

[†] For CSL implementation, use the notation `CACHE_L2WWC_field_symval`

B.1.5 L2 Writeback–Invalidate Base Address Register (L2WIBAR)

Figure B–5. L2 Writeback–Invalidate Base Address Register (L2WIBAR)

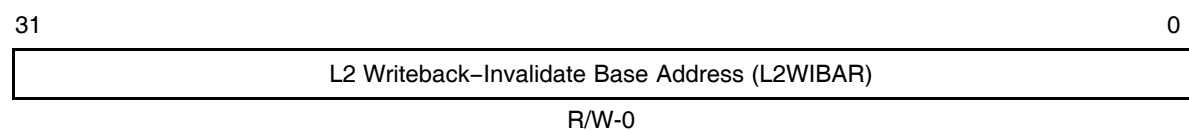

Legend: R/W-x = Read/Write-Reset value

Table B–6. L2 Writeback–Invalidate Base Address Register (L2WIBAR) Field Values

Bit	field [†]	symval [†]	Value	Description
31–0	L2WIBAR	OF(value)	0–FFFF FFFFh	L2 Writeback–Invalidate Base Address.

[†] For CSL implementation, use the notation `CACHE_L2WIBAR_field_symval`

B.1.6 L2 Writeback–Invalidate Count Register (L2WIWC)

Figure B–6. L2 Writeback–Invalidate Word Count Register (L2WIWC)

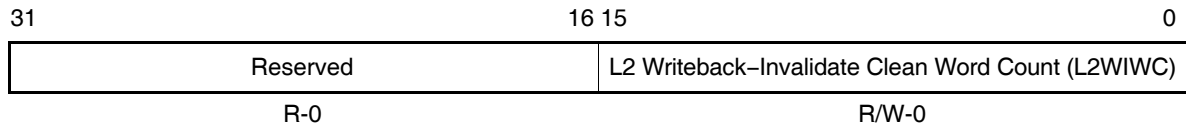

Legend: R/W-x = Read/Write-Reset value

Table B–7. L2 Writeback–Invalidate Word Count Register (L2WIWC) Field Values

Bit	field [†]	symval [†]	Value	Description
31–16	Reserved	–	0	Reserved. The reserved bit location is always read as zero. A value written to this field has no effect.
15–0	L2WIWC	OF(<i>value</i>)	0–FFFFh	L2 Writeback–Invalidate Clean Word Count.

[†] For CSL implementation, use the notation `CACHE_L2WIWC_field_symval`

B.1.7 L2 Invalidate Base Address Register (L2IBAR) (C64x only)

Figure B–7. L2 Invalidate Base Address Register (L2IBAR)

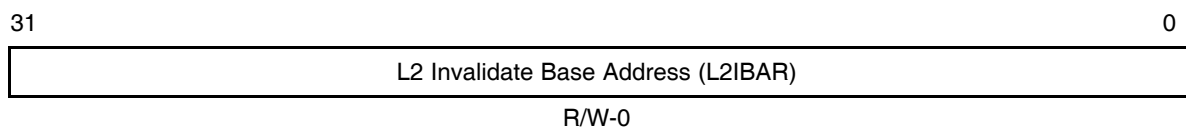

Legend: R/W-x = Read/Write-Reset value

Table B–8. L2 Invalidate Base Address Register (L2IBAR) Field Values

Bit	field [†]	symval [†]	Value	Description
31–0	L2IBAR	OF(<i>value</i>)	0–FFFF FFFFh	L2 Invalidate Base Address.

[†] For CSL implementation, use the notation `CACHE_L2IBAR_field_symval`

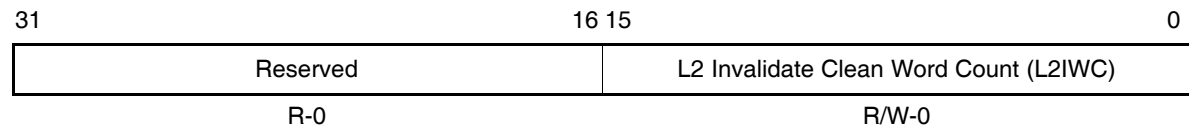
B.1.8 L2 Invalidate Count Register (L2IWC) (C64x only)*Figure B–8. L2 Writeback–Invalidate Word Count Register (L2IWC)*

Legend: R/W-x = Read/Write-Reset value

Table B–9. L2 Invalidate Word Count Register (L2IWC) Field Values

Bit	field [†]	symval [†]	Value	Description
31–16	Reserved	–	0	Reserved. The reserved bit location is always read as zero. A value written to this field has no effect.
15–0	L2IWC	OF(value)	0–FFFFh	L2 Invalidate Clean Word Count.

[†] For CSL implementation, use the notation `CACHE_L2IWC_field_symval`

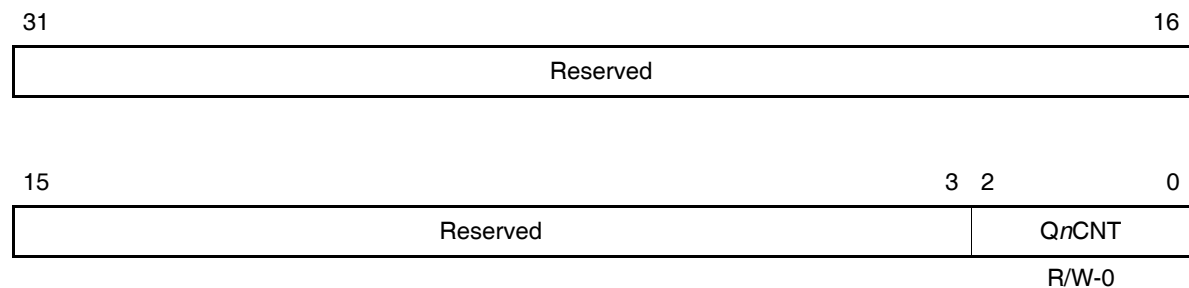
B.1.9 L2 Allocation Priority Queue Registers (L2ALLOC0–L2ALLOC3) (C64x)*Figure B–9. L2 Allocation Registers (L2ALLOC0–L2ALLOC3)*

Legend: R/W-x = Read/Write-Reset value

Table B–10. L2 Allocation Registers (L2ALLOC0–L2ALLOC3) Field Values

Bit	field [†]	symval [†]	Value	Description
31–3	Reserved	–	0	Reserved. The reserved bit location is always read as zero. A value written to this field has no effect.
2–0	QnCNT	OF(value)	0–7h	

[†] For CSL implementation, use the notation `CACHE_L2ALLOCn_field_symval`

B.1.10 L1P Invalidate Base Address Register (L1PIBAR)

Figure B–10. L1P Invalidate Base Address Register (L1PIBAR)

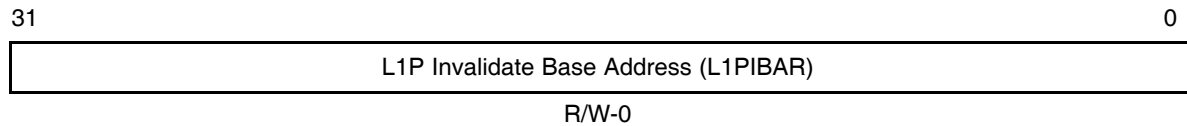

Legend: R/W-x = Read/Write-Reset value

Table B–11. L1P Invalidate Base Address Register (L1PIBAR) Field Values

Bit	field [†]	symval [†]	Value	Description
31–0	L1PIBAR	OF(value)	0–FFFF FFFFh	L1P Invalidate Base Address.

[†] For CSL implementation, use the notation `CACHE_L1PIBAR_field_symval`

B.1.11 L1P Invalidate Word Count Register (L1PIWC)

Figure B–11. L1P Invalidate Word Count Register (L1PIWC)

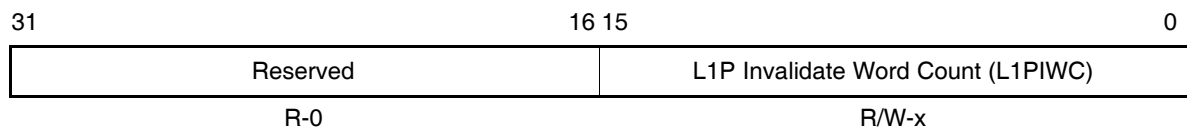

Legend: R/W-x = Read/Write-Reset value

Table B–12. L1P Invalidate Word Count Register (L1PIWC) Field Values

Bit	field [†]	symval [†]	Value	Description
31–16	Reserved	–	0	Reserved. The reserved bit location is always read as zero. A value written to this field has no effect.
15–0	L1PIWC	OF(value)	0–FFFFh	L1P Invalidate Word Count.

[†] For CSL implementation, use the notation `CACHE_L1PIWC_field_symval`

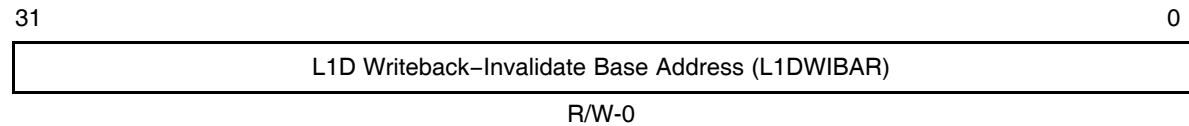
B.1.12 L1D Writeback–Invalidate Base Address Register (L1DWIBAR)*Figure B–12. L1D Writeback–Invalidate Base Address Register (L1DWIBAR)*

Legend: R/W-x = Read/Write-Reset value

Table B–13. L1D Writeback–Invalidate Base Address Register (L1DWIBAR) Field Values

Bit	field [†]	symval [†]	Value	Description
31–0	L1DWIBAR	OF(<i>value</i>)	0–FFFF FFFFh	L1D Writeback–Invalidate Base Address.

[†] For CSL implementation, use the notation `CACHE_L1DWIBAR_field_symval`

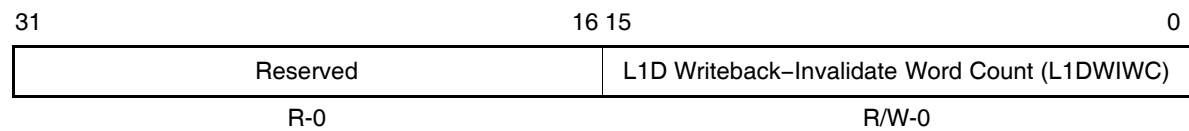
B.1.13 L1D Writeback–Invalidate Word Count Register (L1DWIWC)*Figure B–13. L1D Writeback–Invalidate Word Count Register (L1DWIWC)*

Legend: R/W-x = Read/Write-Reset value

Table B–14. L1D Writeback–Invalidate Word Count Register (L1DWIWC) Field Values

Bit	field [†]	symval [†]	Value	Description
31–16	Reserved	–	0	Reserved. The reserved bit location is always read as zero. A value written to this field has no effect.
15–0	L1DWIWC	OF(<i>value</i>)	0–FFFFh	L1D Writeback–Invalidate Word Count.

[†] For CSL implementation, use the notation `CACHE_L1DWIWC_field_symval`

B.1.14 L1D Invalidate Base Address Register (L1DIBAR) (C64x only)

Figure B–14. L1P Invalidate Base Address Register (L1PIBAR)

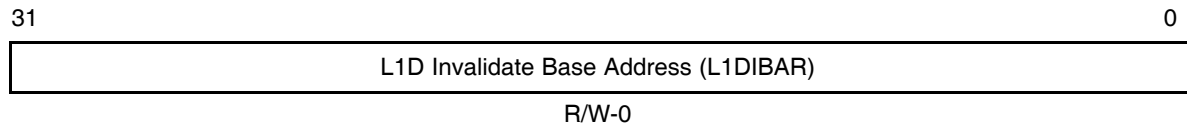

Legend: R/W-x = Read/Write-Reset value

Table B–15. L1D Invalidate Base Address Register (L1DIBAR) Field Values

Bit	field [†]	symval [†]	Value	Description
31–0	L1DIBAR	OF(value)	0–FFFF FFFFh	L1D Invalidate Base Address.

[†] For CSL implementation, use the notation `CACHE_L1DIBAR_field_symval`

B.1.15 L1D Invalidate Word Count Register (L1DIWC) (C64x only)

Figure B–15. L1D Invalidate Word Count Register (L1DIWC)

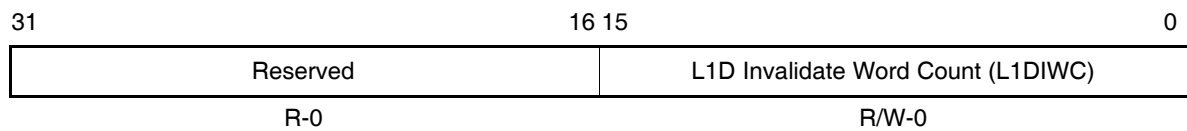

Legend: R/W-x = Read/Write-Reset value

Table B–16. L1D Invalidate Word Count Register (L1DIWC) Field Values

Bit	field [†]	symval [†]	Value	Description
31–16	Reserved	–	0	Reserved. The reserved bit location is always read as zero. A value written to this field has no effect.
15–0	L1DIWC	OF(value)	0–FFFFh	L1D Invalidate Word Count.

[†] For CSL implementation, use the notation `CACHE_L1DIWC_field_symval`

B.1.16 L2 Writeback All Register (L2WB)

The L2 offers both global writeback and global writeback-invalidate operations. Global cache operations in L2 are initiated by writing a 1 to the C bit in L2WB (Figure B–16). Writing a 1 to the C bit of L2WB initiates a global writeback of L2. The C bit continues to read as 1 until the cache operation is complete. Programs can poll to determine when a cache operation is complete.

Figure B–16. L2 Writeback All Register (L2WB)

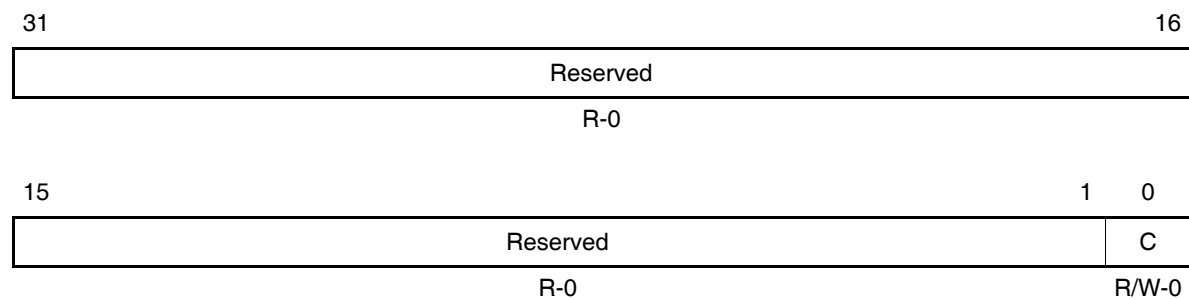

Legend: R/W-x = Read/Write-Reset value

Table B–17. L2 Writeback All Register (L2WB) Field Values

Bit	field [†]	symval [†]	Value	Description
31–1	Reserved	–	0	Reserved. The reserved bit location is always read as zero. A value written to this field has no effect.
0	C			Writeback All L2
		NORMAL	0	Normal L2 operation
		FLUSH	1	All L2 lines writeback all

[†] For CSL implementation, use the notation `CACHE_L2WB_field_symval`

B.1.17 L2 Writeback–Invalidate All Register (L2WBINV)

The L2 offers both global writeback and global writeback-invalidate operations. Global cache operations in L2 are initiated by writing a 1 to the C bit in L2WBINV (Figure B–17). Writing a 1 to the C bit of L2WBINV initiates a global writeback-invalidate of L2. The C bit continues to read as 1 until the cache operation is complete. Programs can poll to determine when a cache operation is complete.

Figure B–17. L2 Writeback–Invalidate All Register (L2WBINV)

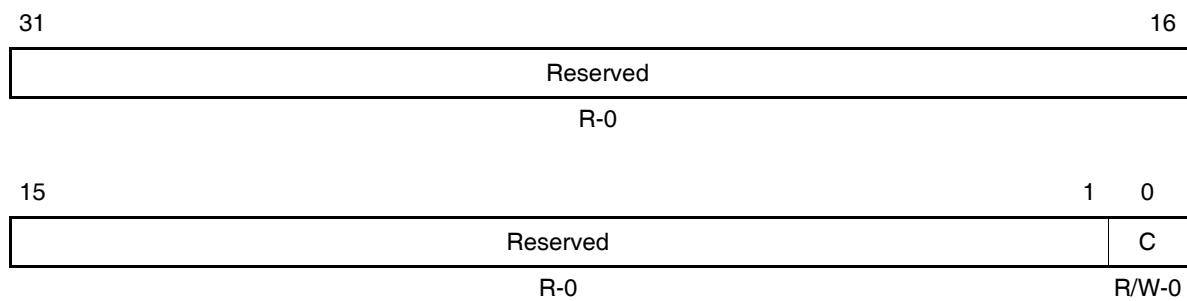

Legend: R/W-x = Read/Write-Reset value

Table B–18. L2 Writeback–Invalidate All Register (L2WBINV) Field Values

Bit	field [†]	symval [†]	Value	Description
31–1	Reserved	–	0	Reserved. The reserved bit location is always read as zero. A value written to this field has no effect.
0	C			Clean L2
		NORMAL	0	Normal L2 operation
		CLEAN	1	All L2 lines writeback–invalidate all

[†] For CSL implementation, use the notation `CACHE_L2WBINV_field_symval`

B.1.18 L2 Memory Attribute Registers (MAR0–MAR15)

The cache enable (CE) bit in each MAR determines whether the L1D, L1P, and L2 are allowed to cache the corresponding address range. After reset, the CE bit in each MAR is cleared to 0, thereby disabling caching of external memory by default. This is in contrast to L2 SRAM, which is always considered cacheable.

To enable caching on a particular external address range, an application should set the CE bit in the appropriate MAR to 1. No special procedure is necessary. Subsequent accesses to the affected address range are cached by the two-level memory system.

Figure B–18. L2 Memory Attribute Registers (MAR0–MAR15)

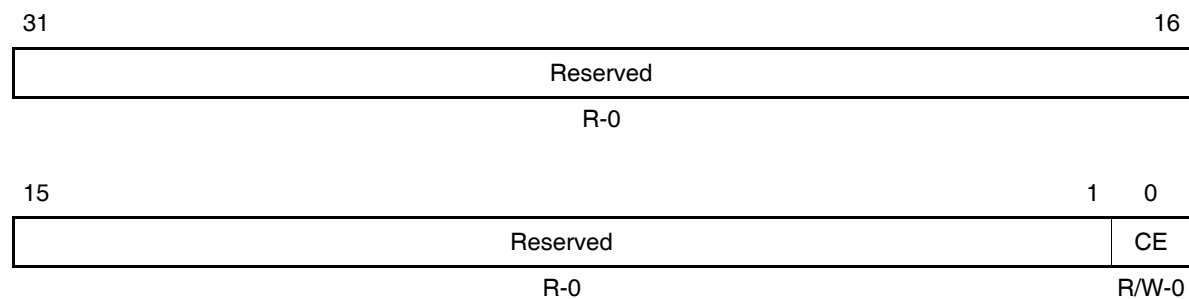

Legend: R/W-x = Read/Write-Reset value

Table B–19. L2 Memory Attribute Registers (MAR0–MAR15) Field Values

Bit	field [†]	symval [†]	Value	Description
31–1	Reserved	–	0	Reserved. The reserved bit location is always read as zero. A value written to this field has no effect.
0	CE			Cache enable bit.
		DISABLE	0	Memory range is not cacheable.
		ENABLE	1	Memory range is cacheable.

[†] For CSL implementation, use the notation `CACHE_MAR_field_symval`

B.1.19 L2 Memory Attribute Registers for EMIFB Only (MAR96–MAR111)

The cache enable (CE) bit in each MAR determines whether the L1D, L1P, and L2 are allowed to cache the corresponding address range. After reset, the CE bit in each MAR is cleared to 0, thereby disabling caching of external memory by default. This is in contrast to L2 SRAM, which is always considered cacheable.

To enable caching on a particular external address range, an application should set the CE bit in the appropriate MAR to 1. No special procedure is necessary. Subsequent accesses to the affected address range are cached by the two-level memory system.

Figure B–19. L2 Memory Attribute Registers (MAR96–MAR111)

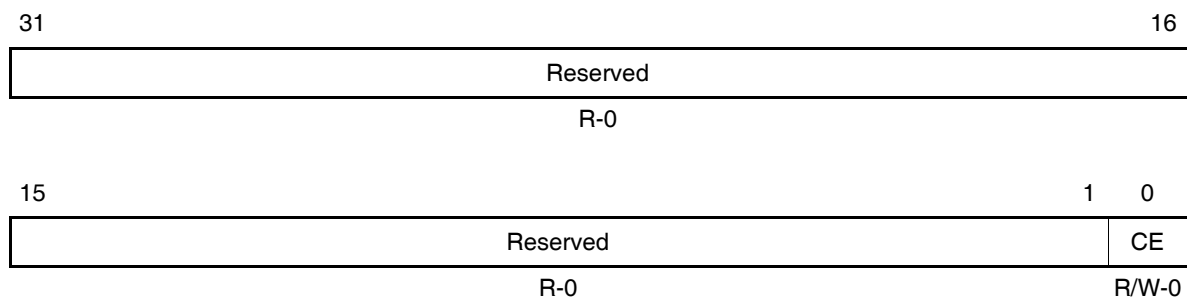

Legend: R/W-x = Read/Write-Reset value

Table B–20. L2 Memory Attribute Registers (MAR96–MAR111) Field Values

Bit	field [†]	symval [†]	Value	Description
31–1	Reserved	–	0	Reserved. The reserved bit location is always read as zero. A value written to this field has no effect.
0	CE			Cache enable bit.
		DISABLE	0	Memory range is not cacheable.
		ENABLE	1	Memory range is cacheable.

[†] For CSL implementation, use the notation `CACHE_MAR_field_symval`

B.1.20 L2 Memory Attribute Registers for EMIFA Only (MAR128–MAR191)

The cache enable (CE) bit in each MAR determines whether the L1D, L1P, and L2 are allowed to cache the corresponding address range. After reset, the CE bit in each MAR is cleared to 0, thereby disabling caching of external memory by default. This is in contrast to L2 SRAM, which is always considered cacheable.

To enable caching on a particular external address range, an application should set the CE bit in the appropriate MAR to 1. No special procedure is necessary. Subsequent accesses to the affected address range are cached by the two-level memory system.

Figure B–20. L2 Memory Attribute Registers (MAR128–MAR191)

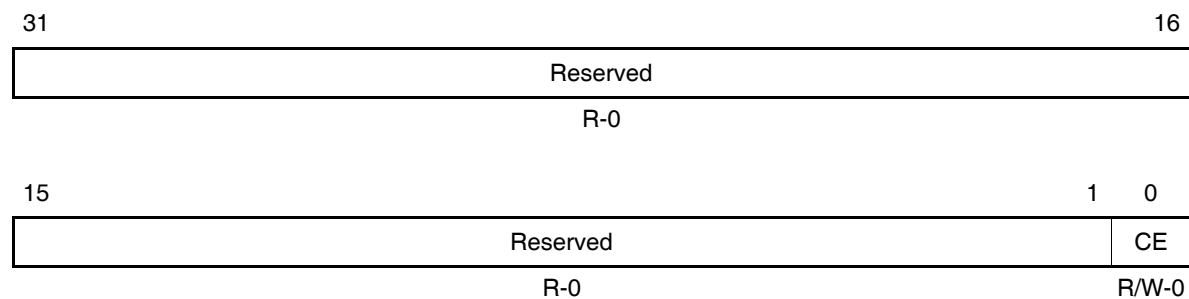

Legend: R/W-x = Read/Write-Reset value

Table B–21. L2 Memory Attribute Registers (MAR128–MAR191) Field Values

Bit	field [†]	symval [†]	Value	Description
31–1	Reserved	–	0	Reserved. The reserved bit location is always read as zero. A value written to this field has no effect.
0	CE			Cache enable bit.
		DISABLE	0	Memory range is not cacheable.
		ENABLE	1	Memory range is cacheable.

[†] For CSL implementation, use the notation `CACHE_MAR_field_symval`

B.2 Direct Memory Access (DMA) Registers

Table B–22. DMA Registers

Acronym	Register Name	Section
AUXCTL	DMA auxiliary control register	B.2.1
PRICTL	DMA channel primary control register	B.2.2
SECCTL	DMA channel secondary control register	B.2.3
SRC	DMA channel source address register	B.2.4
DST	DMA channel destination address register	B.2.5
XFRCNT	DMA channel transfer counter register	B.2.6
GBLCNT	DMA global count reload register	B.2.7
GBLIDX	DMA global index register	B.2.8
GBLADDR	DMA global address reload register	B.2.9

B.2.1 DMA Auxiliary Control Register (AUXCTL)

Figure B–21. DMA Auxiliary Control Register (AUXCTL)

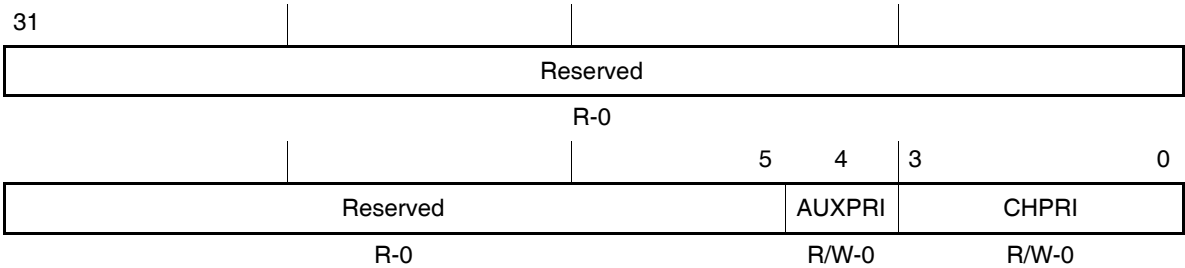

Legend: R/W-x = Read/Write-Reset value

Table B–23. DMA Auxiliary Control Register (AUXCTL) Field Values

Bit	field [†]	symval [†]	Value	Description
31–5	Reserved	–	0	Reserved. The reserved bit location is always read as zero. A value written to this field has no effect.
4	AUXPRI			Auxiliary channel priority mode
		CPU	0	CPU priority
		DMA	1	DMA priority
3–0	CHPRI			DMA channel priority. In the case when the auxiliary channel is used to service the expansion bus host port operation, CHPRI must be 0000b (auxiliary channel highest priority).
		HIGHEST	0	Fixed channel priority mode auxiliary channel highest priority
		2ND	1h	Fixed channel priority mode auxiliary channel 2nd-highest priority
		3RD	2h	Fixed channel priority mode auxiliary channel 3rd-highest priority
		4TH	3h	Fixed channel priority mode auxiliary channel 4th-highest priority
		LOWEST	4h	Fixed channel priority mode auxiliary channel lowest priority
		–	5h–Fh	Reserved

[†] For CSL implementation, use the notation DMA_AUXCTL_field_symval

B.2.2 DMA Channel Primary Control Register (PRICTL)

Figure B–22. DMA Channel Primary Control Register (PRICTL)

31	30	29	28	27	26	25	24
DSTRLD		SRCRLD		EMOD	FS	TCINT	PRI
R/W-0		R/W-0		R/W-0	R/W-0	R/W-0	R/W-0
23	WSYNC			19	18	RSYNC	
R/W-0				R/W-0			
14	13	12	11	10	9	8	
RSYNC		INDEX	CNTRLD	SPLIT		ESIZE	
R/W-0		R/W-0	R/W-0	R/W-0		R/W-0	
7	6	5	4	3	2	1	0
DSTDIR		SRCDIR		STATUS		START	
R/W-0		R/W-0		R-0		R/W-0	

Legend: R/W-x = Read/Write-Reset value

Table B–24. DMA Channel Primary Control Register (PRICTL) Field Values

Bit	field [†]	symval [†]	Value	Description
31–30	DSTRLD	NONE	0	Do not reload during autoinitialization
		B	1h	Use DMA global address register B as reload
		C	2h	Use DMA global address register C as reload
		D	3h	Use DMA global address register D as reload
29–28	SRCRLD	NONE	0	Do not reload during autoinitialization
		B	1h	Use DMA global address register B as reload
		C	2h	Use DMA global address register C as reload
		D	3h	Use DMA global address register D as reload

[†] For CSL implementation, use the notation DMA_PRICTL_field_symval

Table B–24. DMA Channel Primary Control Register (PRICTL) Field Values (Continued)

Bit	field [†]	symval [†]	Value	Description
27	EMOD			Emulation mode
		NOHALT	0	DMA channel keeps running during an emulation halt
		HALT	1	DMA channel pauses during an emulation halt
26	FS			Frame synchronization
		DISABLE	0	Disable
		RSYNC	1	RSYNC event used to synchronize entire frame
25	TCINT			Transfer controller interrupt
		DISABLE	0	Interrupt disabled
		ENABLE	1	Interrupt enabled
24	PRI			Priority mode: DMA versus CPU
		CPU	0	CPU priority
		DMA	1	DMA priority
23–19	WSYNC			Write transfer synchronization
		NONE	0	No synchronization
		TINT0	1h	Timer interrupt event 0
		TINT1	2h	Timer interrupt event 1
		SDINT	3h	
		EXTINT4	4h	External interrupt event 4
		EXTINT5	5h	External interrupt event 5
		EXTINT6	6h	External interrupt event 6
		EXTINT7	7h	External interrupt event 7
		DMAINT0	8h	DMA interrupt event 0
		DMAINT1	9h	DMA interrupt event 1
DMAINT2	Ah	DMA interrupt event 2		

[†] For CSL implementation, use the notation DMA_PRICTL_field_symval

Table B–24. DMA Channel Primary Control Register (PRICTL) Field Values (Continued)

Bit	field [†]	symval [†]	Value	Description
		DMAINT3	Bh	DMA interrupt event 3
		XEVT0	Ch	McBSP 0 transmit event 0
		REVT0	Dh	McBSP 0 receive event
		XEVT1	Eh	McBSP 1 transmit event
		REVT1	Fh	McBSP 1 receive event
		DSPINT	10h	DSP interrupt event
		XEVT2	11h	McBSP 2 transmit event
		REVT2	12h	McBSP 2 receive event
		–	13h–1Fh	Reserved
18–14	RSYNC			Read synchronization
		NONE	0	No synchronization
		TINT0	1h	Timer interrupt event 0
		TINT1	2h	Timer interrupt event 1
		SDINT	3h	
		EXTINT4	4h	External interrupt event 4
		EXTINT5	5h	External interrupt event 5
		EXTINT6	6h	External interrupt event 6
		EXTINT7	7h	External interrupt event 7
		DMAINT0	8h	DMA interrupt event 0
		DMAINT1	9h	DMA interrupt event 1
		DMAINT2	Ah	DMA interrupt event 2
		DMAINT3	Bh	DMA interrupt event 3
		XEVT0	Ch	McBSP 0 transmit event 0
		REVT0	Dh	McBSP 0 receive event
		XEVT1	Eh	McBSP 1 transmit event

[†] For CSL implementation, use the notation DMA_PRICTL_field_symval

Table B–24. DMA Channel Primary Control Register (PRICTL) Field Values (Continued)

Bit	field [†]	symval [†]	Value	Description
		REVT1	Fh	McBSP 1 receive event
		DSPINT	10h	DSP interrupt event
		XEVT2	11h	McBSP 2 transmit event
		REVT2	12h	McBSP 2 receive event
		1–18	13–1Fh	Reserved
13	INDEX			Selects the DMA global data register to use as a programmable index
		A	0	Use DMA global index register A
		B	1	Use DMA global index register B
12	CNTRLD			Transfer counter reload for autoinitialization and multiframe transfers
		A	0	Reload with DMA global count reload register A
		B	1	Reload with DMA global count reload register B
11–10	SPLIT			Split channel mode
		DISABLE	0	Split-channel mode disabled
		A	1h	Split-channel mode enabled; use DMA global address register A as split address
		B	2h	Split-channel mode enabled; use DMA global address register B as split address
		C	3h	Split-channel mode enabled; use DMA global address register C as split address
9–8	ESIZE			Element size
		32 BIT	0	32-bit
		16 BIT	1h	16-bit
		8 BIT	2h	8-bit
		–	3h	Reserved

[†] For CSL implementation, use the notation DMA_PRICTL_field_symval

Table B–24. DMA Channel Primary Control Register (PRICTL) Field Values (Continued)

Bit	field [†]	symval [†]	Value	Description
7–6	DSTDIR			Destination address modification after element transfers
		NONE	0	No modification
		INC	1h	Increment by element size in bytes
		DEC	2h	Decrement by element size in bytes
		IDX	3h	Adjust using DMA global index register selected by INDEX
5–4	SRCDIR			Source address modification after element transfers
		NONE	0	No modification
		INC	1h	Increment by element size in bytes
		DEC	2h	Decrement by element size in bytes
		IDX	3h	Adjust using DMA global index register selected by INDEX
3–2	STATUS			
		STOPPED	0	Stopped
		RUNNING	1h	Running without autoinitialization
		PAUSED	2h	Paused
		AUTORUNNING	3h	Running with autoinitialization
1–0	START			
		STOP	0	Stopped
		NORMAL	1h	Running without autoinitialization
		PAUSE	2h	Paused
		AUTOINIT	3h	Running with autoinitialization

[†] For CSL implementation, use the notation DMA_PRICTL_field_symval

B.2.3 DMA Channel Secondary Control Register (SECCTL)

Figure B–23. DMA Channel Secondary Control Register (SECCTL)

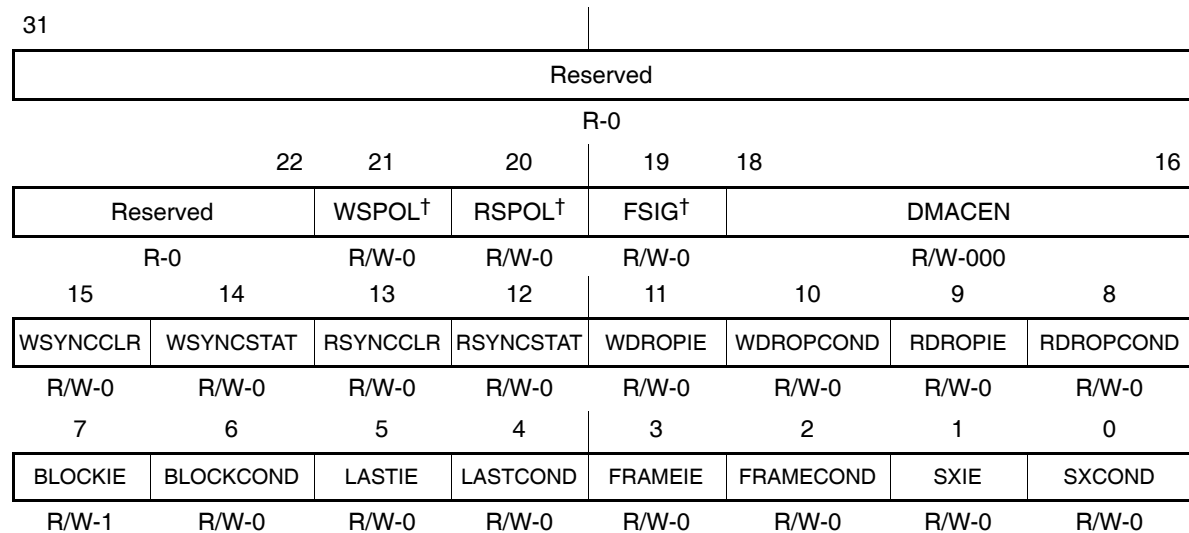

[†] These bits are not available on the C6201 and C6701 devices. These bits are R+0 on the C6201 and C6701 devices.

Legend: R/W-x = Read/Write-Reset value

Table B–25. DMA Channel Secondary Control Register (SECCTL) Field Values

Bit	field [†]	symval [†]	Value	Description
31–22	Reserved	–	0	Reserved. The reserved bit location is always read as zero. A value written to this field has no effect.
21	WSPOL			Write synchronization event polarity (not applicable for C6201 and C6701 devices). This field is valid only if EXT_INTx is selected.
		ACTIVEHIGH	0	Active high
		ACTIVELOW	1	Active low
20	RSPOL			Read and frame synchronization event polarity (not applicable for C6201 and C6701 devices). This field is valid only if EXT_INTx is selected.
		ACTIVEHIGH	0	Active high
		ACTIVELOW	1	Active low

[†] For CSL implementation, use the notation DMA_SECCTL_field_symval

Table B–25. DMA Channel Secondary Control Register (SECCTL) Field Values (Continued)

Bit	field [†]	symval [†]	Value	Description
19	FSIG			Level/edge detect mode selection. FSIG must be cleared to 0 for non-frame-synchronized transfers (not applicable for C6201 and C6701 devices).
		NORMAL	0	Edge detect mode (FS = 1 or FS = 0).
		IGNORE	1	Level detect mode (valid only when FS = 1). In level detect mode, synchronization inputs received during a frame transfer are ignored unless still set after the frame transfer completes.
18–16	DMACEN			DMA action complete pins reflect status and condition.
		LOW	0	DMAC pin is held low.
		HIGH	1h	DMAC pin is held high.
		RSYNCSTAT	2h	DMAC reflects RSYNCSTAT.
		WSYNCSTAT	3h	DMAC reflects WSYNCSTAT.
		FRAMECOND	4h	DMAC reflects FRAMECOND.
		BLOCKCOND	5h	DMAC reflects BLOCKCOND.
	–	6h–7h	Reserved	
15	WSYNCCLR			Write synchronization status clear bit.
		NOTHING	0	No effect.
		CLEAR	1	Clear write synchronization status.
14	WSYNCSTAT			Write synchronization status.
		CLEAR	0	Synchronization is not received.
		SET	1	Synchronization is received.
13	RSYNCCLR			Read synchronization status clear bit.
		NOTHING	0	No effect.
		CLEAR	1	Clear read synchronization status.

[†] For CSL implementation, use the notation DMA_SECCTL_field_symval

Table B–25. DMA Channel Secondary Control Register (SECCTL) Field Values (Continued)

Bit	field [†]	symval [†]	Value	Description
12	RSYNCSTAT			Read synchronization status.
		CLEAR	0	Synchronization is not received.
		SET	1	Synchronization is received.
11	WDROPIE			Write synchronization dropped interrupt enable.
		DISABLE	0	WDROP condition does not enable DMA channel interrupt.
		ENABLE	1	WDROP condition enables DMA channel interrupt.
10	WDROPCOND			Write drop condition.
		CLEAR	0	WDROP condition is not detected.
		SET	1	WDROP condition is detected.
9	RDROPIE			Read synchronization dropped interrupt enable.
		DISABLE	0	RDROP condition does not enable DMA channel interrupt.
		ENABLE	1	RDROP condition enables DMA channel interrupt.
8	RDROPCOND			Read drop condition.
		CLEAR	0	RDROP condition is not detected.
		SET	1	RDROP condition is detected.
7	BLOCKIE			Block transfer finished interrupt enable.
		DISABLE	0	BLOCK condition does not enable DMA channel interrupt.
		ENABLE	1	BLOCK condition enables DMA channel interrupt.
6	BLOCKCOND			Block transfer finished condition.
		CLEAR	0	BLOCK condition is not detected.
		SET	1	BLOCK condition is detected.

[†] For CSL implementation, use the notation DMA_SECCTL_field_symval

Table B–25. DMA Channel Secondary Control Register (SECCTL) Field Values (Continued)

Bit	field [†]	symval [†]	Value	Description
5	LASTIE			Last frame finished interrupt enable.
		DISABLE	0	LAST condition does not enable DMA channel interrupt.
		ENABLE	1	LAST condition enables DMA channel interrupt.
4	LASTCOND			Last frame finished condition.
		CLEAR	0	LAST condition is not detected.
		SET	1	LAST condition is detected.
3	FRAMEIE			Frame complete interrupt enable.
		DISABLE	0	FRAME condition does not enable DMA channel interrupt.
		ENABLE	1	FRAME condition enables DMA channel interrupt.
2	FRAMECOND			Frame complete condition.
		CLEAR	0	FRAME condition is not detected.
		SET	1	FRAME condition is detected.
1	SXIE			Split transmit overrun receive interrupt enable.
		DISABLE	0	SX condition does not enable DMA channel interrupt.
		ENABLE	1	SX condition enables DMA channel interrupt.
0	SXCOND			Split transmit condition.
		CLEAR	0	SX condition is not detected.
		SET	1	SX condition is detected.

[†] For CSL implementation, use the notation DMA_SECCTL_field_symval

B.2.4 DMA Channel Source Address Register (SRC)

Figure B–24. DMA Channel Source Address Register (SRC)

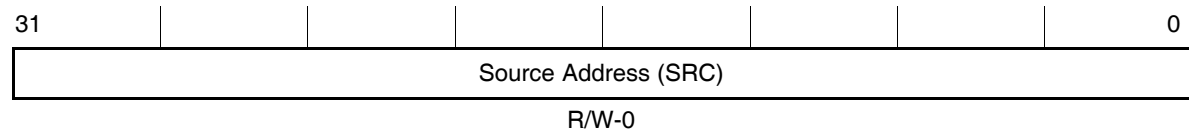

Legend: R/W-x = Read/Write-Reset value

Table B–26. DMA Channel Source Address Register (SRC) Field Values

Bit	Field	<i>symval</i> [†]	Value	Description
31–0	SRC	OF(<i>value</i>)	0–FFFF FFFFh	Source Address

[†] For CSL implementation, use the notation DMA_SRC_SRC_*symval*

B.2.5 DMA Channel Destination Address Register (DST)

Figure B–25. DMA Channel Destination Address Register (DST)

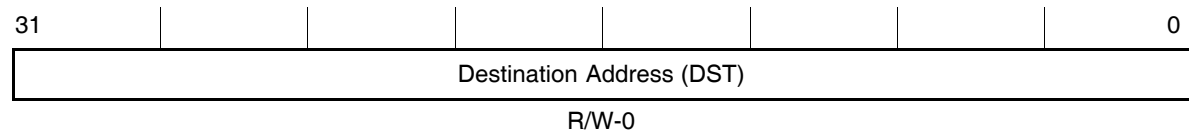

Legend: R/W-x = Read/Write-Reset value

Table B–27. DMA Channel Destination Address Register (DST) Field Values

Bit	Field	<i>symval</i> [†]	Value	Description
31–0	DST	OF(<i>value</i>)	0–FFFF FFFFh	Destination Address

[†] For CSL implementation, use the notation DMA_DST_DST_*symval*

B.2.6 DMA Channel Transfer Counter Register (XFRCNT)

Figure B–26. DMA Channel Transfer Counter Register (XFRCNT)

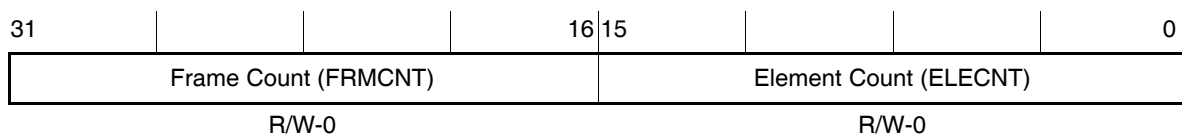

Legend: R/W-x = Read/Write-Reset value

Table B–28. DMA Channel Transfer Counter Register (XFRCNT) Field Values

Bit	field [†]	symval [†]	Value	Description
31–16	FRMCNT	OF(value)	0–FFFFh	Frame Count
15–0	ELECNT	OF(value)	0–FFFFh	Element Count

[†] For CSL implementation, use the notation DMA_XFRCNT_field_symval

B.2.7 DMA Global Count Reload Register (GBLCNT)

Figure B–27. DMA Global Count Reload Register (GBLCNT)

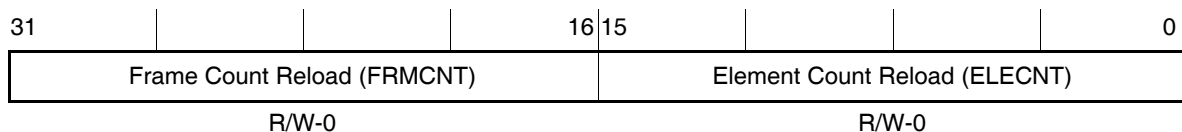

Legend: R/W-x = Read/Write-Reset value

Table B–29. DMA Global Count Reload Register (GBLCNT) Field Values

Bit	field [†]	symval [†]	Value	Description
31–16	FRMCNT	OF(value)	0–FFFFh	This 16-bit value reloads FRMCNT bits in XFRCNT.
15–0	ELECNT	OF(value)	0–FFFFh	This 16-bit value reloads ELECNT bits in XFRCNT.

[†] For CSL implementation, use the notation DMA_GBLCNT_field_symval

B.2.8 DMA Global Index Register (GBLIDX)

Figure B–28. DMA Global Index Register (GBLIDX)

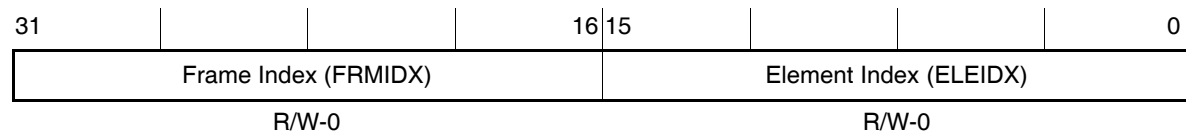

Legend: R/W-x = Read/Write-Reset value

Table B–30. DMA Global Index Register (GBLIDX) Field Values

Bit	field†	symval†	Value	Description
31–16	FRMIDX	OF(value)	0–FFFFh	Frame Index
15–0	ELEIDX	OF(value)	0–FFFFh	Element Index

† For CSL implementation, use the notation DMA_GBLIDX_field_symval

B.2.9 DMA Global Address Reload Register (GBLADDR)

Figure B–29. DMA Global Address Reload Register (GBLADDR)

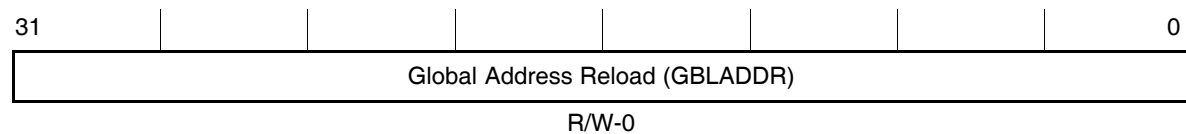

Legend: R/W-x = Read/Write-Reset value

Table B–31. DMA Global Address Reload Register (GBLADDR) Field Values

Bit	Field	symval†	Value	Description
31–0	GBLADDR	OF(value)	0–FFFF FFFFh	Global Address Reload

† For CSL implementation, use the notation DMA_GBLADDR_GBLADDR_symval

B.3 Enhanced DMA (EDMA) Registers

Table B–32. EDMA Registers

Acronym	Register Name	Section
OPT	EDMA channel options register	B.3.1
SRC	EDMA channel source address register	B.3.2
CNT	EDMA channel transfer count register	B.3.3
DST	EDMA channel destination address register	B.3.4
IDX	EDMA channel index register	B.3.5
RLD	EDMA channel count reload/link register	B.3.6
ESEL	EDMA event selector registers (C621x/C671x)	B.3.7
PQAR	EDMA priority queue allocation registers (C64x)	B.3.8
PQSR	EDMA priority queue status register (C621x/C671x)	B.3.9
PQSR	EDMA priority queue status register (C64x)	B.3.10
CIPR	EDMA channel interrupt pending register (C621x/C671x)	B.3.11
CIPRL	EDMA channel interrupt pending low register (C64x)	B.3.12
CIPRH	EDMA channel interrupt pending high register (C64x)	B.3.13
CIER	EDMA channel interrupt enable register (C621x/C671x)	B.3.14
CIERL	EDMA channel interrupt enable low register (C64x)	B.3.15
CIERH	EDMA channel interrupt enable high register (C64x)	B.3.16
CCER	EDMA channel chain enable register (C621x/C671x)	B.3.17
CCERL	EDMA channel chain enable low register (C64x)	B.3.18
CCERH	EDMA channel chain enable high register (C64x)	B.3.19
ER	EDMA event register (C621x/C671x)	B.3.20
ERL	EDMA event low register (C64x)	B.3.21
ERH	EDMA event high register (C64x)	B.3.22
EER	EDMA event enable register (C621x/C671x)	B.3.23
EERL	EDMA event enable low register (C64x)	B.3.24
EERH	EDMA event enable high register (C64x)	B.3.25

Table B–32. EDMA Registers (Continued)

Acronym	Register Name	Section
ECR	EDMA event clear register (C621x/C671x)	B.3.26
ECRL	EDMA event clear low register (C64x)	B.3.27
ECRH	EDMA event clear high register (C64x)	B.3.28
ESR	EDMA event set register (C621x/C671x)	B.3.29
ESRL	EDMA event set low register (C64x)	B.3.30
ESRH	EDMA event set high register (C64x)	B.3.31
EPRL	EDMA event polarity low register (C64x)	B.3.32
EPRH	EDMA event set polarity register (C64x)	B.3.33

B.3.1 EDMA Channel Options Register (OPT)

Figure B–30. EDMA Channel Options Register (OPT)

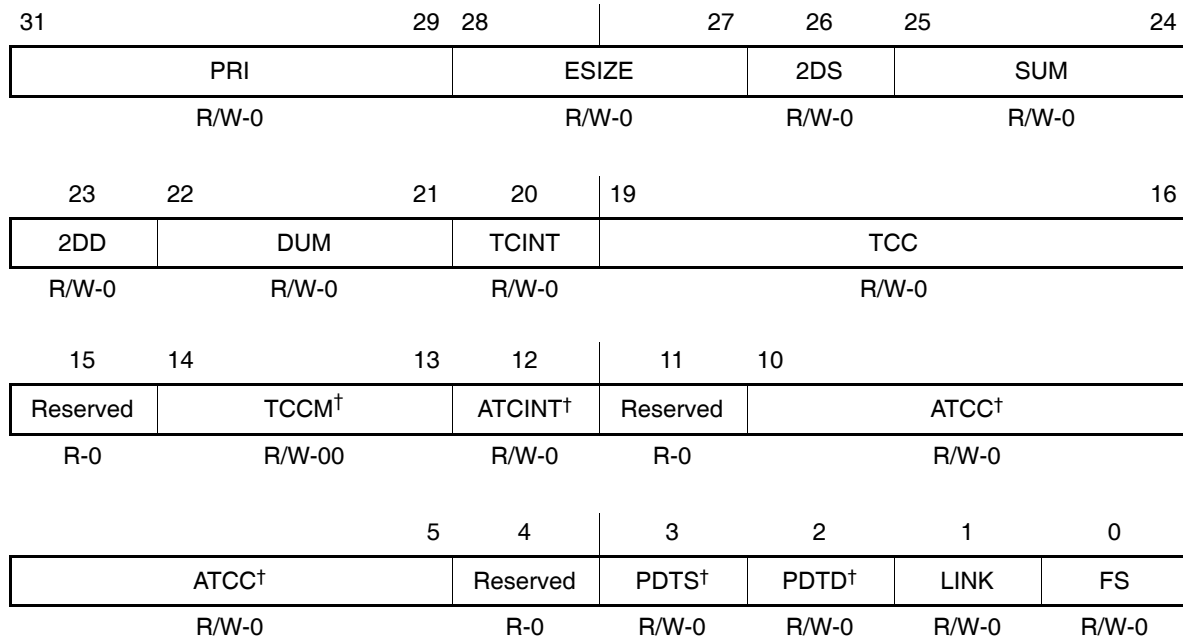

[†] Applies to C64x only. On C621x/C671x, these bits are Reserved, R+0.

Legend: R/W-x = Read/Write-Reset value

Table B–33. EDMA Channel Options Register (OPT) Field Values

Bit	field [†]	symval [†]	Value	Description
31–29	PRI			Priority levels for EDMA events
				For C64x:
		URGENT	0	Urgent priority.
		HIGH	1h	This level is available for CPU and EDMA transfer requests.
		MEDIUM	2h	Medium priority EDMA transfer
		LOW	3h	Low priority EDMA transfer
				For C62x, C67x:
		HIGH	1h	This level is reserved only for L2 requests and not valid for EDMA transfer requests.
		LOW	2h	Low priority EDMA transfer requests.
28–27	ESIZE			Element size
		32 BIT	0	32-bit word
		16 BIT	1h	16-bit half-word
		8 BIT	2h	8-bit byte
		–	3h	Reserved
26	2DS			Source dimension
		NO	0	1-dimensional source.
		YES	1	2-dimensional source.
25–24	SUM			Source address update mode
		NONE	0	Fixed address mode. No source address modification
		INC	1h	Source address increment depends on 2DS and FS bits
		DEC	2h	Source address decrement depends on 2DS and FS bits
		IDX	3h	Source address modified by the element index/frame index depending on 2DS and FS bits.

[†] For CSL implementation, use the notation EDMA_OPT_field_symval.

Table B–33. EDMA Channel Options Register (OPT) Field Values (Continued)

Bit	field [†]	symval [†]	Value	Description
23	2DD			Destination dimension
		NO	0	1-dimensional destination
		YES	1	2-dimensional destination
22–21	DUM			Destination address update mode
		NONE	0	Fixed address mode. No destination address modification
		INC	1h	Destination address increment depends on 2DD and FS bits
		DEC	2h	Destination address decrement depends on 2DD and FS bits
		IDX	3h	Destination address modified by the element index/frame index depending on 2DD and FS bits.
20	TCINT			Transfer complete interrupt
		NO	0	Transfer complete indication disabled. CIPR bits are not set upon completion of a transfer.
		YES	1	The relevant CIPR bit is set on channel transfer completion. The bit (position) set in the CIPR is the TCC value specified.
19–16	TCC	OF(value)	0–Fh	Transfer complete code 4-bit code is used to set the relevant bit in CIPR (i.e. CIPR[TCC] bit) provided. For C64x, the 4-bit TCC code is used in conjunction with bit field TCCM for a 6-bit transfer complete code.
15	Reserved	–	0	Reserved. The reserved bit location is always read as zero. A value written to this field has no effect.
14–13	TCCM	OF(value)	0–3h	Transfer complete code most-significant bits. This 2-bit value works in conjunction with the TCC bits to provide a 6-bit transfer complete code. The 6-bit code is used to set the relevant bit in the EDMA channel interrupt pending register (CIPRL or CIPRH) provided TCINT = 1, when the current set is exhausted.

[†] For CSL implementation, use the notation EDMA_OPT_field_symval.

Table B–33. EDMA Channel Options Register (OPT) Field Values (Continued)

Bit	field [†]	symval [†]	Value	Description
12	ATCINT			Alternate transfer complete interrupt.
		NO	0	Alternate transfer complete indication is disabled. The EDMA channel interrupt pending register (CIPRL or CIPRH) bits are not set upon completion of intermediate transfers in a block.
		YES	1	Alternate transfer complete indication is enabled. The EDMA channel interrupt pending register (CIPRL or CIPRH) bit is set upon completion of intermediate transfers in a block. The bit (position) set in CIPRL or CIPRH is the ATCC value specified.
11	Reserved	–	0	Reserved. The reserved bit location is always read as zero. A value written to this field has no effect.
10–5	ATCC	OF(<i>value</i>)	0–3Fh	Alternate transfer complete code. This 6-bit value is used to set the bit in the EDMA channel interrupt pending register (CIPRL or CIPRH) (CIP[ATCC] bit) provided ATCINT = 1, upon completion of an intermediate transfer in a block. This bit can be used for chaining and interrupt generation.
4	Reserved	–	0	Reserved. The reserved bit location is always read as zero. A value written to this field has no effect.
3	PDTs			Peripheral device transfer (PDT) mode for source.
		DISABLE	0	PDT read is disabled.
		ENABLE	1	PDT read is enabled.
2	PDTd			Peripheral device transfer (PDT) mode for destination.
		DISABLE	0	PDT write is disabled.
		ENABLE	1	PDT write is enabled.
1	LINK			Linking of event parameters enable.
		NO	0	Linking of event parameters disabled. Entry not reloaded.
		YES	1	Linking of event parameters enabled. After the current set is exhausted, the channel entry is reloaded with the parameter set specified by the link address. The link address must be on a 24-byte boundary and within the EDMA PaRAM. The link address is a 16-bit address offset from the PaRAM base address.

[†] For CSL implementation, use the notation EDMA_OPT_field_symval.

Table B–33. EDMA Channel Options Register (OPT) Field Values (Continued)

Bit	field [†]	symval [†]	Value	Description
0	FS			Frame synchronization
		NO	0	Channel is element/array synchronized.
		YES	1	Channel is frame synchronized. The relevant event for a given EDMA channel is used to synchronize a frame.

[†] For CSL implementation, use the notation EDMA_OPT_field_symval.

B.3.2 EDMA Channel Source Address Register (SRC)

Figure B–31. EDMA Channel Source Address Register (SRC)

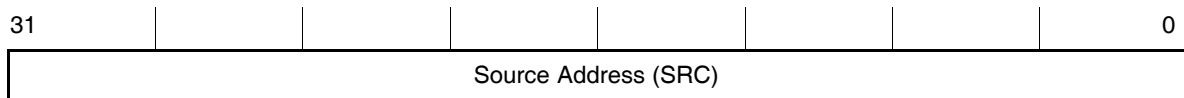
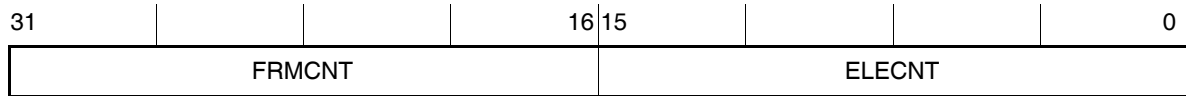

Table B–34. EDMA Channel Source Address Register (SRC) Field Values

Bit	Field	symval [†]	Value	Description
31–0	SRC	OF(value)	0–FFFF FFFFh	This 32-bit source address specifies the starting byte address of the source. The address is modified using the SUM bits in the EDMA channel options parameter (OPT).

[†] For CSL implementation, use the notation EDMA_SRC_SRC_symval.

B.3.3 EDMA Channel Transfer Count Register (CNT)*Figure B–32. EDMA Channel Transfer Count Register (CNT)**Table B–35. EDMA Channel Transfer Count Register (CNT) Field Values*

Bit	field [†]	symval [†]	Value	Description
31–16	FRMCNT	OF(<i>value</i>)	0–FFFFh	Frame/array count. A 16-bit unsigned value plus 1 that specifies the number of frames in a 1D block or number of arrays in a 2D block. Valid values for the frame/array count: 0–65535.
15–0	ELECNT	OF(<i>value</i>)	1–FFFFh	Element count. A 16-bit unsigned value that specifies the number of elements in a frame for (1D transfers) or an array (for 2D transfers). Valid values for the element count: 1–65535.

[†] For CSL implementation, use the notation `EDMA_CNT_field_symval`.

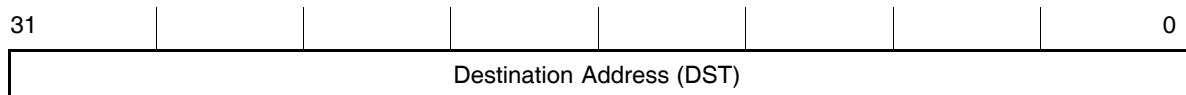
B.3.4 EDMA Channel Destination Address Register (DST)*Figure B–33. EDMA Channel Destination Address Register (DST)**Table B–36. EDMA Channel Destination Address Register (DST) Field Values*

Bit	Field	symval [†]	Value	Description
31–0	DST	OF(<i>value</i>)	0–FFFF FFFFh	This 32-bit destination address specifies the starting byte address of the destination. The address is modified using the DUM bits in the EDMA channel options parameter (OPT).

[†] For CSL implementation, use the notation `EDMA_DST_DST_symval`.

B.3.5 EDMA Channel Index Register (IDX)

Figure B–34. EDMA Channel Index Register (IDX)

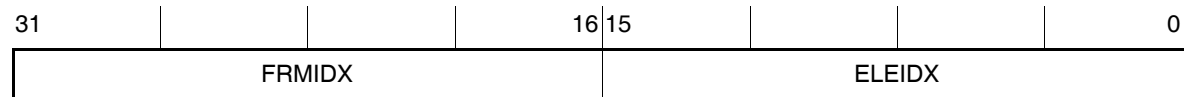

Table B–37. EDMA Channel Index Register (IDX) Field Values

Bit	field [†]	symval [†]	Value	Description
31–16	FRMIDX	OF(value)	0–FFFFh	Frame/array index. A 16-bit signed value that specifies the frame/array index used for an address offset to the next frame/array. Valid values for the frame/array index: –32768 to 32767.
15–0	ELEIDX	OF(value)	0–FFFFh	Element index. A 16-bit signed value that specifies the element index used for an address offset to the next element in a frame. Element index is used <i>only</i> for 1D transfers. Valid values for the element index: –32768 to 32767.

[†] For CSL implementation, use the notation EDMA_IDX_field_symval.

B.3.6 EDMA Channel Count Reload/Link Register (RLD)

Figure B–35. EDMA Channel Count Reload/Link Register (RLD)

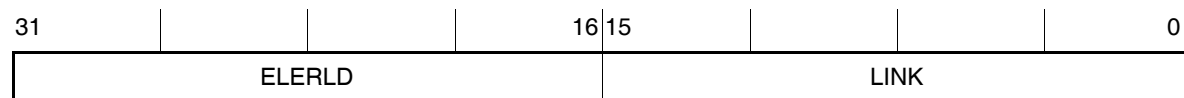
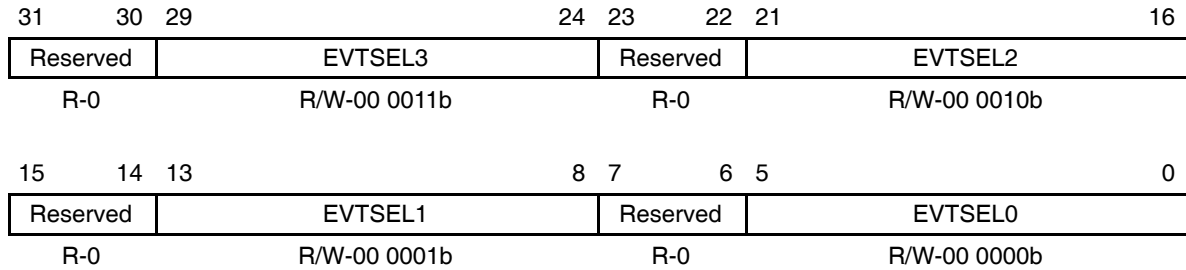

Table B–38. EDMA Channel Count Reload/Link Register (RLD) Field Values

Bit	field [†]	symval [†]	Value	Description
31–16	ELERLD	OF(value)	0–FFFFh	Element count reload. A 16-bit unsigned value used to reload the element count field in the EDMA channel transfer count parameter (CNT) once the last element in a frame is transferred. This field is used only for a 1D element sync (FS = 0) transfer, since the EDMA has to keep track of the next element address using the element count. This is necessary for multi-frame EDMA transfers where frame count value is greater than 0.
15–0	LINK	OF(value)	0–FFFFh	This 16-bit link address specifies the lower 16-bit address in the parameter RAM from which the EDMA loads/reloads the parameters of the next event in the chain.

[†] For CSL implementation, use the notation EDMA_RLD_field_symval.

B.3.7 EDMA Event Selector Registers (ESEL0, 1, 3)*Figure B–36. EDMA Event Selector Register 0 (ESEL0)*

Legend: R = Read only, R/W = Read/Write; -n = value after reset

Table B–39. EDMA Event Selector Register 0 (ESEL0) Field Values

Bit	Field	Value	Description
31–30	Reserved	0	Reserved. You should always write 0 to this field.
29–24	EVTSEL3	0–3Fh	Event selector 3. This 6-bit value maps event 3 to any EDMA channel.
23–22	Reserved	0	Reserved. You should always write 0 to this field.
21–16	EVTSEL2	0–3Fh	Event selector 2. This 6-bit value maps event 2 to any EDMA channel.
15–14	Reserved	0	Reserved. You should always write 0 to this field.
13–8	EVTSEL1	0–3Fh	Event selector 1. This 6-bit value maps event 1 to any EDMA channel.
7–6	Reserved	0	Reserved. You should always write 0 to this field.
5–0	EVTSEL0	0–3Fh	Event selector 0. This 6-bit value maps event 0 to any EDMA channel.

Figure B–37. EDMA Event Selector Register 1 (ESEL1)

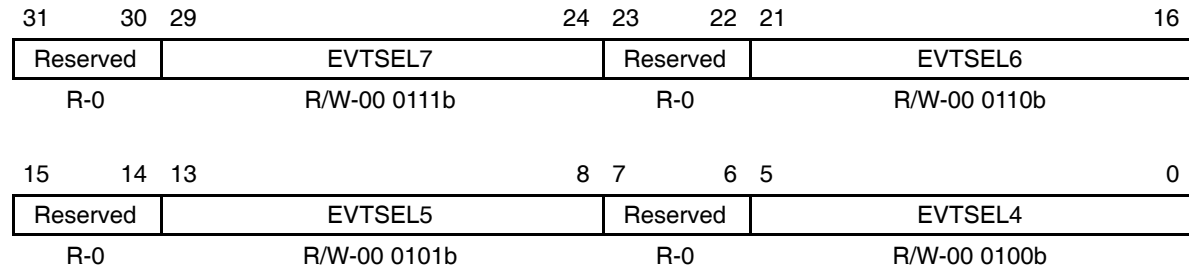

Legend: R = Read only, R/W = Read/Write; -n = value after reset

Table B–40. EDMA Event Selector Register 0 (ESEL0) Field Values

Bit	Field	Value	Description
31–30	Reserved	0	Reserved. You should always write 0 to this field.
29–24	EVTSEL7	0–3Fh	Event selector 7. This 6-bit value maps event 7 to any EDMA channel.
23–22	Reserved	0	Reserved. You should always write 0 to this field.
21–16	EVTSEL6	0–3Fh	Event selector 6. This 6-bit value maps event 6 to any EDMA channel.
15–14	Reserved	0	Reserved. You should always write 0 to this field.
13–8	EVTSEL5	0–3Fh	Event selector 5. This 6-bit value maps event 5 to any EDMA channel.
7–6	Reserved	0	Reserved. You should always write 0 to this field.
5–0	EVTSEL4	0–3Fh	Event selector 4. This 6-bit value maps event 4 to any EDMA channel.

Figure B–38. EDMA Event Selector Register 3 (ESEL3)

31	30	29		24	23	22	21		16
Reserved		EVTSEL15				Reserved		EVTSEL14	
R-0		R/W-00 1111b				R-0		R/W-00 1110b	
15	14	13		8	7	6	5		0
Reserved		EVTSEL13				Reserved		EVTSEL12	
R-0		R/W-00 1101b				R-0		R/W-00 1100b	

Legend: R = Read only, R/W = Read/Write; -n = value after reset

Table B–41. EDMA Event Selector Register 0 (ESEL3) Field Values

Bit	Field	Value	Description
31–30	Reserved	0	Reserved. You should always write 0 to this field.
29–24	EVTSEL15	0–3Fh	Event selector 15. This 6-bit value maps event 15 to any EDMA channel.
23–22	Reserved	0	Reserved. You should always write 0 to this field.
21–16	EVTSEL14	0–3Fh	Event selector 14. This 6-bit value maps event 14 to any EDMA channel.
15–14	Reserved	0	Reserved. You should always write 0 to this field.
13–8	EVTSEL13	0–3Fh	Event selector 13. This 6-bit value maps event 13 to any EDMA channel.
7–6	Reserved	0	Reserved. You should always write 0 to this field.
5–0	EVTSEL12	0–3Fh	Event selector 12. This 6-bit value maps event 12 to any EDMA channel.

B.3.8 Priority Queue Allocation Registers (PQAR0–3) (C64x)

Figure B–39. Priority Queue Allocation Register (PQAR)

31	Reserved	3	2	1	0
		Rsvd [†]	PQA2	PQA1	PQA0
	R-0	R/W-0	R-0 [‡]	R-1 [‡]	R-0 [‡]

Legend: R = Read only; R/W = Read/Write; -n = value after reset

[†] Always write 0 to the reserved bit.

[‡] For PQAR0 and PQAR2, the default value is 010b; for PQAR1 and PQAR3, the default value is 110b.

Table B–42. Priority Queue Allocation Register (PQAR) Field Values

Bit	Field	symval [†]	Value	Description
31–4	Reserved	–	0	Reserved. You should always write 0 to this field.
3	Reserved	–	0	Reserved. The reserved bit location is always read as 0. If writing to this field, always write a 0.
2–0	PQA	OF(value)	0–7h	Priority queue allocation bits determine the queue length available to EDMA requests.

[†] For CSL implementation, use the notation `EDMA_PQAR0_PQA_symval`, `EDMA_PQAR1_PQA_symval`, `EDMA_PQAR2_PQA_symval`, and `EDMA_PQAR3_PQA_symval`.

B.3.9 Priority Queue Status Register (PQSR) (C621x/C671x)*Figure B–40. Priority Queue Status Register (PQSR)*

31		3	2	1	0
Reserved			PQ2	PQ1	PQ0
R-0			R-1	R-1	R-1

Legend: R/W-x = Read/Write-Reset value

Table B–43. Priority Queue Status Register (PQSR) Field Values

Bit	Field	symval [†]	Value	Description
31–3	Reserved	–	0	Reserved. You should always write 0 to this field.
2–0	PQ	OF(value)	0–7h	Priority queue status. A 1 in the PQ bit indicates that there are no requests pending in the respective priority level queue.

[†] For CSL implementation, use the notation EDMA_PQSR_PQ_symval.

B.3.10 Priority Queue Status Register (PQSR) (C64x)*Figure B–41. Priority Queue Status Register (PQSR)*

31		4	3	2	1	0
Reserved			PQ3	PQ2	PQ1	PQ0
R-0			R-1	R-1	R-1	R-1

Legend: R/W-x = Read/Write-Reset value

Table B–44. Priority Queue Status Register (PQSR) Field Values

Bit	Field	symval	Value	Description
31–4	Reserved			Reserved. The reserved bit location is always read as zero. A value written to this field has no effect.
3–0	PQ	OF(value)	0–Fh	Priority queue status. A 1 in the PQ bit indicates that there are no requests pending in the respective priority level queue.

[†] For CSL implementation, use the notation EDMA_PQSR_PQ_symval.

B.3.11 EDMA Channel Interrupt Pending Register (CIPR) (C621x/C671x)

Figure B–42. EDMA Channel Interrupt Pending Register (CIPR)

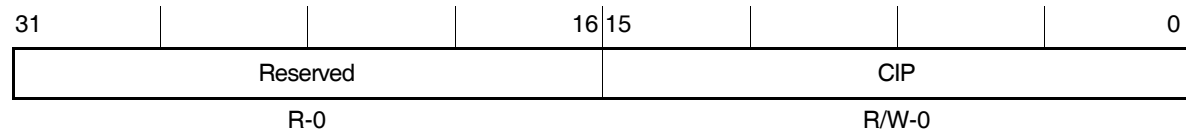

Legend: R/W-x = Read/Write-Reset value

Table B–45. EDMA Channel Interrupt Pending Register (CIPR) Field Values

Bit	Field	symval [†]	Value	Description
31–16	Reserved	–	0	Reserved. You should always write 0 to this field.
15–0	CIP	OF(value)	0–FFFFh	Channel interrupt pending. When the TCINT bit in the channel options parameter (OPT) is set to 1 for an EDMA channel and a specific transfer complete code (TCC) is provided by the EDMA transfer controller, the EDMA channel controller sets a bit in the CIP field.

[†] For CSL implementation, use the notation EDMA_CIPR_CIP_symval.

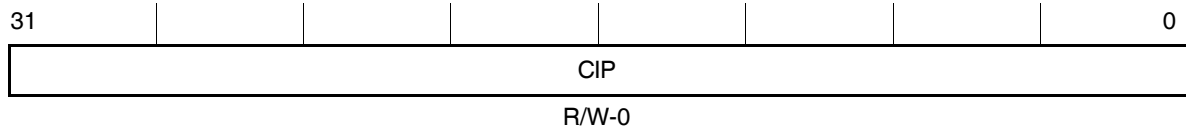
B.3.12 EDMA Channel Interrupt Pending Low Register (CIPRL) (C64x)*Figure B–43. EDMA Channel Interrupt Pending Low Register (CIPRL)*

Legend: R/W-x = Read/Write-Reset value

Table B–46. EDMA Channel Interrupt Pending Low Register (CIPRL) Field Values

Bit	Field	symval [†]	Value	Description
31–0	CIP	OF(value)	0–FFFF FFFFh	Channel 0–31 interrupt pending. When the TCINT or ATCINT bit in the channel options parameter (OPT) is set to 1 for an EDMA channel and a specific transfer complete code (TCC) or alternate transfer complete code (ATCC) is provided by the EDMA transfer controller, the EDMA channel controller sets a bit in the CIP field.

[†] For CSL implementation, use the notation EDMA_CIPRL_CIP_symval.

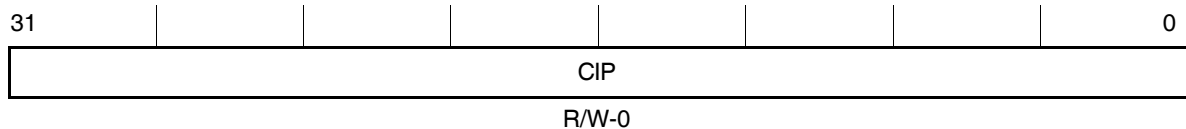
B.3.13 EDMA Channel Interrupt Pending High Register (CIPRH) (C64x)*Figure B–44. EDMA Channel Interrupt Pending High Register (CIPRH)*

Legend: R/W-x = Read/Write-Reset value

Table B–47. EDMA Channel Interrupt Pending High Register (CIPRH) Field Values

Bit	Field	symval [†]	Value	Description
31–0	CIP	OF(value)	0–FFFF FFFFh	Channel 32–63 interrupt pending. When the TCINT or ATCINT bit in the channel options parameter (OPT) is set to 1 for an EDMA channel and a specific transfer complete code (TCC) or alternate transfer code complete code (ATCC) is provided by the EDMA transfer controller, the EDMA channel controller sets a bit in the CIP field.

[†] For CSL implementation, use the notation EDMA_CIPRH_CIP_symval.

B.3.14 EDMA Channel Interrupt Enable Register (CIER) (C621x/C671x)

Figure B–45. EDMA Channel Interrupt Enable Register (CIER)

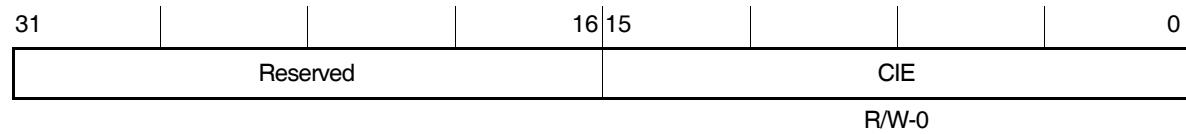

Legend: R/W-x = Read/Write-Reset value

Table B–48. C621x/C671x: Channel Interrupt Enable Register (CIER) Field Values

Bit	Field	symval [†]	Value	Description
31–16	Reserved	–	0	Reserved. You should always write 0 to this field.
15–0	CIER	OF(value)	0–FFFFh	Channel interrupt enable. A 16-bit unsigned value used to disable (bit value = 0) or enable (bit value = 1) an interrupt for an EDMA channel.

[†] For CSL implementation, use the notation EDMA_CIER_CIE_symval.

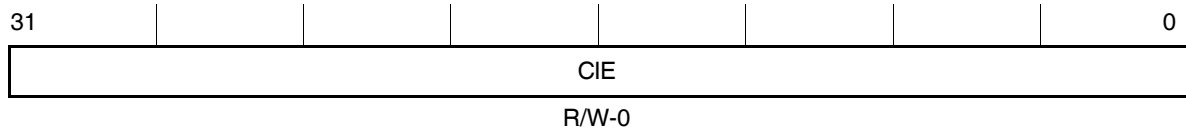
B.3.15 EDMA Channel Interrupt Enable Low Register (CIERL) (C64x)*Figure B–46. EDMA Channel Interrupt Enable Low Register (CIERL)*

Legend: R/W-x = Read/Write-Reset value

Table B–49. EDMA Channel Interrupt Enable Low Register (CIERL) Field Values

Bit	Field	symval [†]	Value	Description
31–0	CIE	OF(value)	0–FFFF FFFFh	Channel 0–31 interrupt enable. A 32-bit unsigned value used to disable (bit value = 0) or enable (bit value = 1) an interrupt for an EDMA channel.

[†] For CSL implementation, use the notation EDMA_CIERL_CIE_symval.

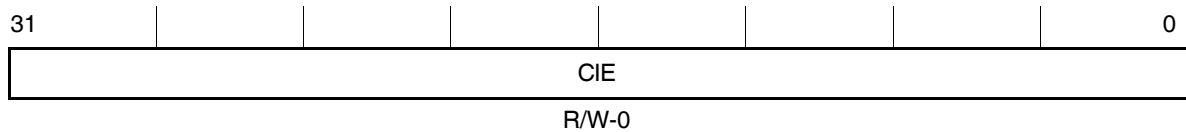
B.3.16 EDMA Channel Interrupt Enable High Register (CIERH) (C64x)*Figure B–47. EDMA Channel Interrupt Enable High Register (CIERH)*

Legend: R/W-x = Read/Write-Reset value

Table B–50. EDMA Channel Interrupt Enable High Register (CIERH) Field Values

Bit	Field	symval [†]	Value	Description
31–0	CIE	OF(value)	0–FFFF FFFFh	Channel 32–63 interrupt enable. A 32-bit unsigned value used to disable (bit value = 0) or enable (bit value = 1) an interrupt for an EDMA channel.

[†] For CSL implementation, use the notation EDMA_CIERH_CIE_symval.

B.3.17 EDMA Channel Chain Enable Register (CCER) (C621x/C671x)

Figure B–48. EDMA Channel Chain Enable Register (CCER)

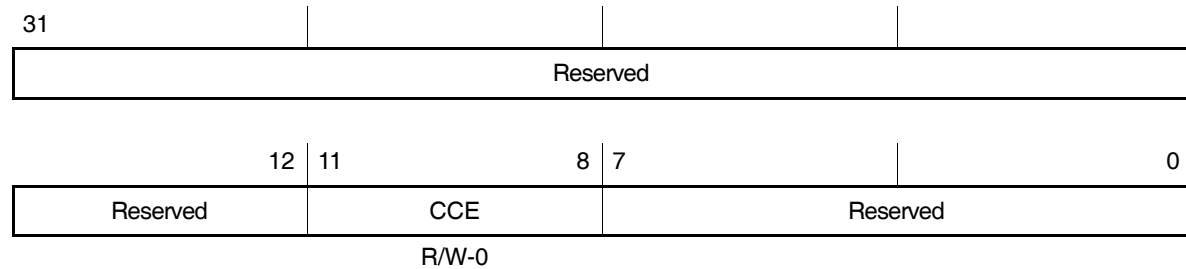

Legend: R/W-x = Read/Write-Reset value

Table B–51. EDMA Channel Chain Enable Register (CCER) Field Values

Bit	Field	<i>symval</i> [†]	Value	Description
31–12	Reserved	–	0	Reserved. You should always write 0 to this field.
11–8	CCE	OF(<i>value</i>)	0–Fh	Channel chain enable. To enable the EDMA controller to chain channels by way of a single event, set the TCINT bit in the channel options parameter (OPT) to 1. Additionally, set the relevant bit in the CCE field to trigger off the next channel transfer specified by TCC.
7–0	Reserved	–	0	Reserved. You should always write 0 to this field.

[†] For CSL implementation, use the notation EDMA_CCER_CCE_*symval*.

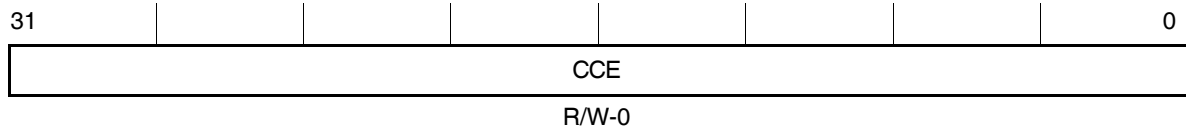
B.3.18 EDMA Channel Chain Enable Low Register (CCERL) (C64x)*Figure B–49. EDMA Channel Chain Enable Low Register (CCERL)*

Legend: R/W-x = Read/Write-Reset value

Table B–52. EDMA Channel Chain Enable Low Register (CCERL) Field Values

Bit	Field	symval [†]	Value	Description
31–0	CCE	OF(value)	0–FFFF FFFFh	Channel 0–31 chain enable. To enable the EDMA controller to chain channels by way of a single event, set the TCINT or ATCINT bit in the channel options parameter (OPT) to 1. Additionally, set the relevant bit in the CCE field to trigger off the next channel transfer specified by the transfer complete code (TCC) or alternate transfer complete code (ATCC).

[†] For CSL implementation, use the notation EDMA_CCERL_CCE_symval.

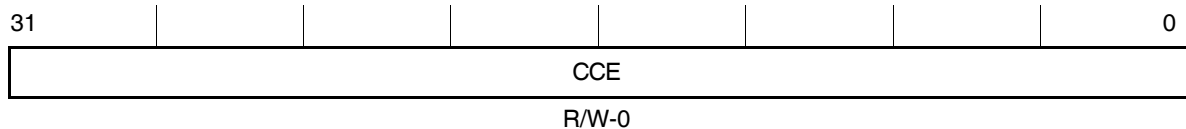
B.3.19 EDMA Channel Chain Enable High Register (CCERH) (C64x)*Figure B–50. EDMA Channel Chain Enable High Register (CCERH)*

Legend: R/W-x = Read/Write-Reset value

Table B–53. EDMA Channel Chain Enable High Register (CCERH) Field Values

Bit	Field	symval [†]	Value	Description
31–0	CCE	OF(value)	0–FFFF FFFFh	Channel 32–63 chain enable. To enable the EDMA controller to chain channels by way of a single event, set the TCINT or ATCINT bit in the channel options parameter (OPT) to 1. Additionally, set the relevant bit in the CCE field to trigger off the next channel transfer specified by the transfer complete code (TCC) or alternate transfer complete code (ATCC).

[†] For CSL implementation, use the notation EDMA_CCERH_CCE_symval.

B.3.20 EDMA Event Register (ER) (C621x/C671x)

Figure B–51. EDMA Event Register (ER)

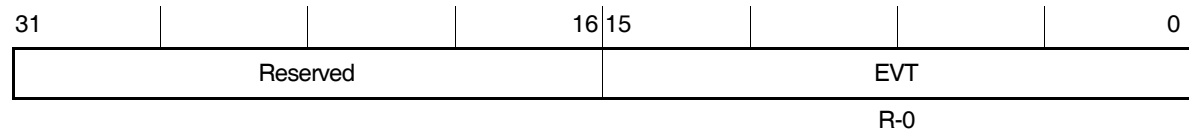

Legend: R/W-x = Read/Write-Reset value

Table B–54. EDMA Event Register (ER) Field Values

Bit	Field	<i>symval</i> [†]	Value	Description
31–16	Reserved	–	0	Reserved. You should always write 0 to this field.
15–0	EVT	OF(<i>value</i>)	0–FFFFh	Event. All events that are captured by the EDMA are latched in ER, even if that event is disabled.

[†] For CSL implementation, use the notation EDMA_ER_EVT_*symval*.

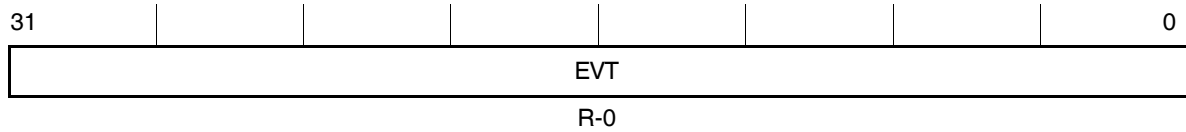
B.3.21 EDMA Event Low Register (ERL) (C64x)*Figure B–51. EDMA Event Low Register (ERL)*

Legend: R/W-x = Read/Write-Reset value

Table B–55. EDMA Event Low Register (ERL) Field Values

Bit	Field	symval [†]	Value	Description
31–0	EVT	OF(value)	0–FFFF FFFFh	Event 0–31. Events 0–31 captured by the EDMA are latched in ERL, even if that event is disabled.

[†] For CSL implementation, use the notation `EDMA_ERL_EVT_symval`.

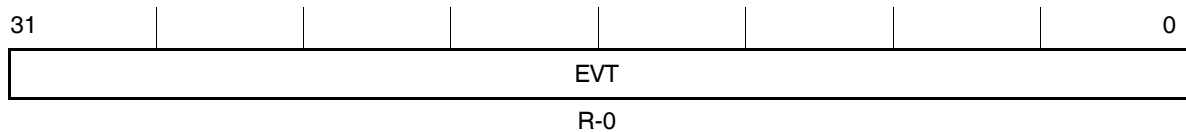
B.3.22 EDMA Event High Register (ERH) (C64x)*Figure B–52. EDMA Event High Register (ERH)*

Legend: R/W-x = Read/Write-Reset value

Table B–56. EDMA Event High Register (ERH) Field Values

Bit	Field	symval [†]	Value	Description
31–0	EVT	OF(value)	0–FFFF FFFFh	Event 32–63. Events 32–63 captured by the EDMA are latched in ERH, even if that event is disabled.

[†] For CSL implementation, use the notation `EDMA_ERH_EVT_symval`.

B.3.23 EDMA Event Enable Register (EER) (C621x/C671x)

Figure B–53. EDMA Event Enable Register (EER)

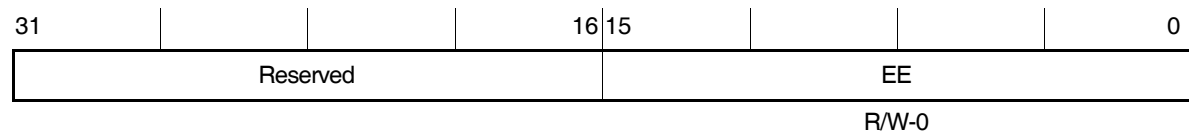

Legend: R/W-x = Read/Write-Reset value

Table B–57. EDMA Event Enable Register (EER) Field Values

Bit	Field	<i>symval</i> [†]	Value	Description
31–16	Reserved	–	0	Reserved. You should always write 0 to this field.
15–0	EE	OF(<i>value</i>)	0–FFFFh	Event enable. Any of the event bits can be set to 1 to enable that event or be cleared to 0 to disable that event. Note that bits 11–8 are only available for chaining of EDMA events; therefore, they are enabled in the channel chain enable register (CCER). Bits 11–8 are reserved and should only be written with 0.

[†] For CSL implementation, use the notation `EDMA_EER_EE_symval`.

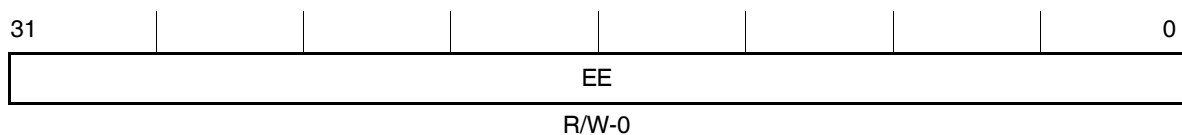
B.3.24 EDMA Event Enable Low Register (EERL) (C64x)*Figure B–54. EDMA Event Enable Low Register (EERL)*

Legend: R/W-x = Read/Write-Reset value

Table B–58. EDMA Event Low Register (EERL) Field Values

Bit	Field	symval [†]	Value	Description
31–0	EE	OF(value)	0–FFFF FFFFh	Event 0–31 enable. Any of the event bits can be set to 1 to enable that event or be cleared to 0 to disable that event.

[†] For CSL implementation, use the notation `EDMA_EERL_EE_symval`.

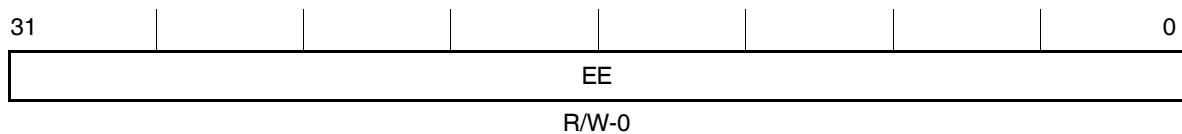
B.3.25 EDMA Event Enable High Register (EERH) (C64x)*Figure B–55. EDMA Event Enable High Register (EERH)*

Legend: R/W-x = Read/Write-Reset value

Table B–59. EDMA Event Enable High Register (EERH) Field Values

Bit	Field	symval [†]	Value	Description
31–0	EE	OF(value)	0–FFFF FFFFh	Event 32–63 enable. Any of the event bits can be set to 1 to enable that event or be cleared to 0 to disable that event.

[†] For CSL implementation, use the notation `EDMA_EERH_EE_symval`.

B.3.26 EDMA Event Clear Register (ECR) (C621x/C671x)

Figure B–56. EDMA Event Clear Register (ECR)

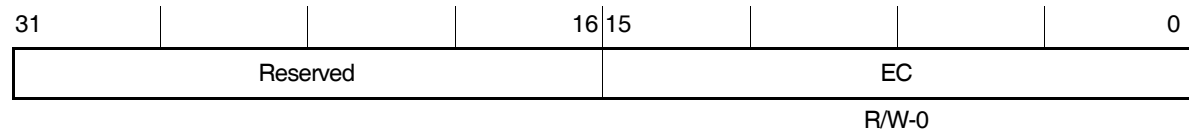

Legend: R/W-x = Read/Write-Reset value

Table B–60. EDMA Event Clear Register (ERC) Field Values

Bit	Field	<i>symval</i> [†]	Value	Description
31–16	Reserved	–	0	Reserved. You should always write 0 to this field.
15–0	EC	OF(<i>value</i>)	0–FFFFh	Event clear. Any of the event bits can be set to 1 to clear that event; a write of 0 has no effect.

[†] For CSL implementation, use the notation EDMA_ECR_EC_*symval*.

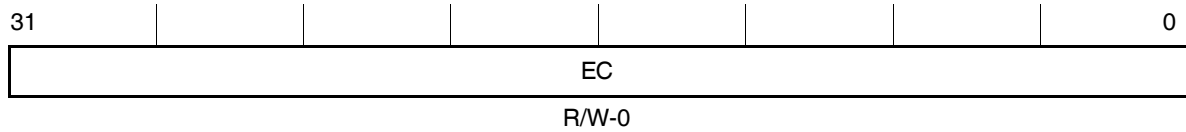
B.3.27 EDMA Event Clear Low Register (ECRL) (C64x)*Figure B–57. EDMA Event Clear Low Register (ECRL)*

Legend: R/W-x = Read/Write-Reset value

Table B–61. EDMA Event Clear Low Register (ERCL) Field Values

Bit	Field	symval [†]	Value	Description
31–0	EC	OF(value)	0–FFFF FFFFh	Event 0–31 clear. Any of the event bits can be set to 1 to clear that event; a write of 0 has no effect.

[†] For CSL implementation, use the notation `EDMA_ECRL_EC_symval`.

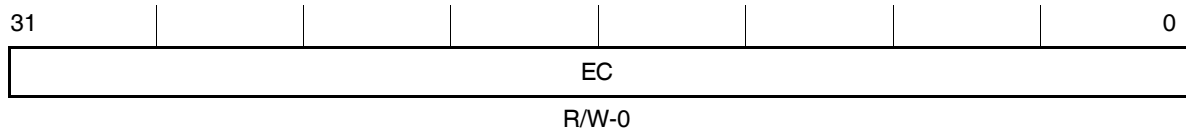
B.3.28 EDMA Event Clear High Register (ECRH) (C64x)*Figure B–58. EDMA Event Clear High Register (ECRH)*

Legend: R/W-x = Read/Write-Reset value

Table B–62. EDMA Event Clear High Register (ECRH) Field Values

Bit	Field	symval [†]	Value	Description
31–0	EC	OF(value)	0–FFFF FFFFh	Event 32–63 clear. Any of the event bits can be set to 1 to clear that event; a write of 0 has no effect.

[†] For CSL implementation, use the notation `EDMA_ECRH_EC_symval`.

B.3.29 EDMA Event Set Register (ESR) (C621x/C671x)

Figure B–59. EDMA Event Set Register (ESR)

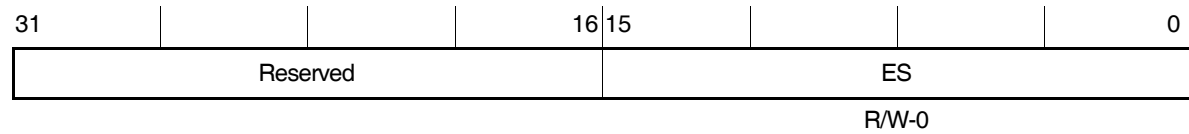

Legend: R/W-x = Read/Write-Reset value

Table B–63. EDMA Event Set Register (ESR) Field Values

Bit	Field	<i>symval</i> [†]	Value	Description
31–16	Reserved	–	0	Reserved. You should always write 0 to this field.
15–0	ES	OF(<i>value</i>)	0–FFFFh	Event set. Any of the event bits can be set to 1 to set the corresponding bit in the event register (ER); a write of 0 has no effect.

[†] For CSL implementation, use the notation EDMA_ESR_ES_*symval*.

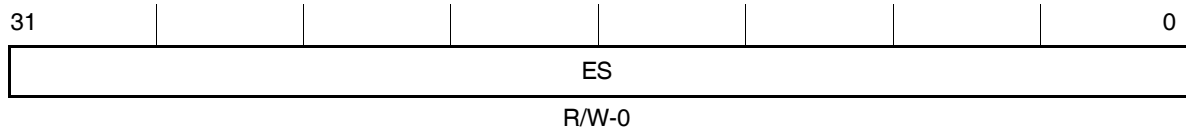
B.3.30 EDMA Event Set Low Register (ESRL) (C64x)*Figure B–60. EDMA Event Set Low Register (ESRL)*

Legend: R/W-x = Read/Write-Reset value

Table B–64. EDMA Event Set Low Register (ESRL) Field Values

Bit	Field	<i>symval</i> [†]	Value	Description
31–0	ES	OF(<i>value</i>)	0–FFFF FFFFh	Event 0–31 set. Any of the event bits can be set to 1 to set the corresponding bit in the event low register (ERL); a write of 0 has no effect.

[†] For CSL implementation, use the notation EDMA_ESRL_ES_*symval*.

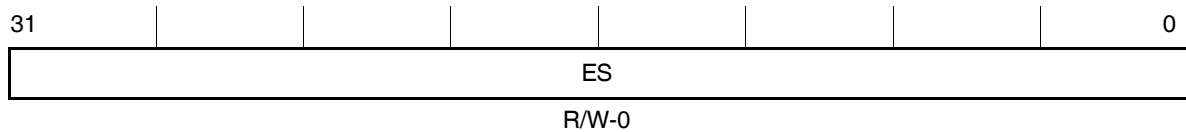
B.3.31 EDMA Event Set High Register (ESRH) (C64x)*Figure B–61. EDMA Event Set High Register (ESRH)*

Legend: R/W-x = Read/Write-Reset value

Table B–65. EDMA Event Set High Register (ESRH) Field Values

Bit	Field	<i>symval</i> [†]	Value	Description
31–0	ES	OF(<i>value</i>)	0–FFFF FFFFh	Event 32–63 set. Any of the event bits can be set to 1 to set the corresponding bit in the event high register (ERH); a write of 0 has no effect.

[†] For CSL implementation, use the notation EDMA_ESRH_ES_*symval*.

B.3.32 EDMA Event Polarity Low Register (EPRL)

Figure B–62. EDMA Event Polarity Low Register (EPRL)

31	30	29	28	27	26	25	24
EP31	EP30	EP29	EP28	EP27	EP26	EP25	EP24
R/W-0	R/W-0	R/W-0	R/W-0	R/W-0	R/W-0	R/W-0	R/W-0
23	22	21	20	19	18	17	16
EP23	EP22	EP21	EP20	EP19	EP18	EP17	EP16
R/W-0	R/W-0	R/W-0	R/W-0	R/W-0	R/W-0	R/W-0	R/W-0
15	14	13	12	11	10	9	8
EP15	EP14	EP13	EP12	EP11	EP10	EP9	EP8
R/W-0	R/W-0	R/W-0	R/W-0	R/W-0	R/W-0	R/W-0	R/W-0
7	6	5	4	3	2	1	0
EP7	EP6	EP5	EP4	EP3	EP2	EP1	EP0
R/W-0	R/W-0	R/W-0	R/W-0	R/W-0	R/W-0	R/W-0	R/W-0

Legend: R/W = Read/Write; -n = value after reset

Table B–66. EDMA Event Polarity Low Register (EPRL) Field Values

Bit	Field	symval [†]	Value	Description
31–0	EP	OF(value)	0–FFFF FFFFh	Event 0–31 polarity. A 32-bit unsigned value used to select a rising edge (bit value = 0) or falling edge (bit value = 1) to determine when an event is triggered on its input.

[†] For CSL implementation, use the notation EDMA_EPRL_EP_symval.

B.3.33 EDMA Event Polarity High Register (EPRH)*Figure B–63. EDMA Event Polarity High Register (EPRH)*

31	30	29	28	27	26	25	24
EP63	EP62	EP61	EP60	EP59	EP58	EP57	EP56
R/W-0	R/W-0	R/W-0	R/W-0	R/W-0	R/W-0	R/W-0	R/W-0
23	22	21	20	19	18	17	16
EP55	EP54	EP53	EP52	EP51	EP50	EP49	EP48
R/W-0	R/W-0	R/W-0	R/W-0	R/W-0	R/W-0	R/W-0	R/W-0
15	14	13	12	11	10	9	8
EP47	EP46	EP45	EP44	EP43	EP42	EP41	EP40
R/W-0	R/W-0	R/W-0	R/W-0	R/W-0	R/W-0	R/W-0	R/W-0
7	6	5	4	3	2	1	0
EP39	EP38	EP37	EP36	EP35	EP34	EP33	EP32
R/W-0	R/W-0	R/W-0	R/W-0	R/W-0	R/W-0	R/W-0	R/W-0

Legend: R/W = Read/Write; -n = value after reset

Table B–67. EDMA Event Polarity High Register (EPRH) Field Values

Bit	Field	symval [†]	Value	Description
31–0	EP	OF(value)	0–FFFF FFFFh	Event 32–63 polarity. A 32-bit unsigned value used to select a rising edge (bit value = 0) or falling edge (bit value = 1) to determine when an event is triggered on its input.

[†] For CSL implementation, use the notation EDMA_EPRH_EP_symval.

B.4 EMAC Control Module Registers

Control registers for the EMAC control module are summarized in Table B–68. See the device-specific datasheet for the memory address of these registers.

Table B–68. EMAC Control Module Registers

Acronym	Register Name	Section
EWTRCTRL	EMAC Control Module Transfer Control Register	B.4.1
EWCTL	EMAC Control Module Interrupt Control Register	B.4.2
EWINTTCNT	EMAC Control Module Interrupt Timer Count Register	B.4.3

B.4.1 EMAC Control Module Transfer Control Register (EWTRCTRL)

The EMAC control module transfer control register (EWTRCTRL) is shown in Figure B–64 and described in Table B–69. EWTRCTRL is used to control the priority and allocation of transfer requests generated by the EMAC. EWTRCTRL should be written only when the EMAC is idle or when being held in reset using the EWCTL register.

Figure B–64. EMAC Control Module Transfer Control Register (EWTRCTRL)

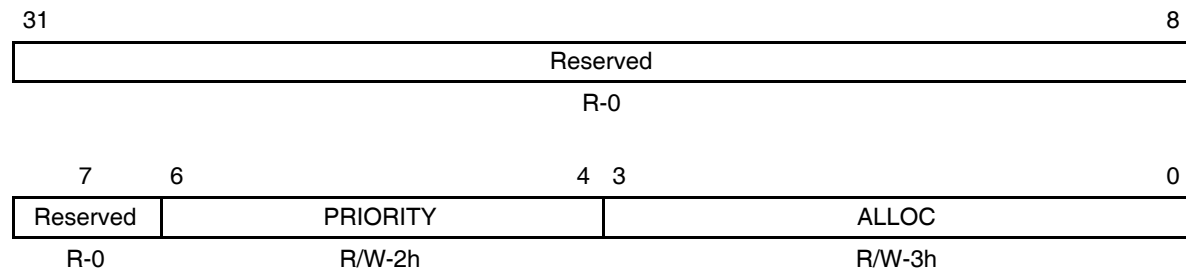

Legend: R = Read only; R/W = Read/Write; -n = value after reset

Table B–69. EMAC Control Module Transfer Control Register (EWTRCTRL) Field Values

Bit	field [†]	symval [†]	Value	Description
31–7	Reserved	–	0	Reserved. The reserved bit location is always read as 0. A value written to this field has no effect.
6–4	PRIORITY		0–7h	Priority bits specify the relative priority of EMAC packet data transfers relative to other memory operations in the system. Although the default value is medium priority, since the EMAC data transfer is real time (once a packet transfer begins), this priority may need to be raised in some system.
			0	Urgent priority
			1h	High priority
			2h	Medium priority
			3h	Low priority
			4h–7h	Reserved
3–0	ALLOC		0–Fh	Allocation bits specify the number of outstanding EMAC requests that can be pending at any given time. Since the EMAC has only three internal FIFOs, an allocation amount of 3 is ideal.

[†] For CSL implementation, use the notation EMAC_EWTRCTRL_field_symval

B.4.2 EMAC Control Module Interrupt Control Register (EWCTL)

The EMAC control module interrupt control register (EWCTL) is shown in Figure B–65 and described in Table B–70. EWCTL is used to enable and disable the central interrupt from the EMAC and MDIO modules and to reset both modules or either module independently.

It is expected that any time, the EMAC and MDIO interrupt is being serviced, the software disables the INTEN bit in EWCTL. This ensures that the interrupt line goes back to zero. The software reenables the INTEN bit after clearing all the pending interrupts and before leaving the interrupt service routine. At this point, if the EMAC control module monitors any interrupts still pending, it reasserts the interrupt line, and generates a new edge that the DSP can recognize.

Figure B–65. EMAC Control Module Interrupt Control Register (EWCTL)

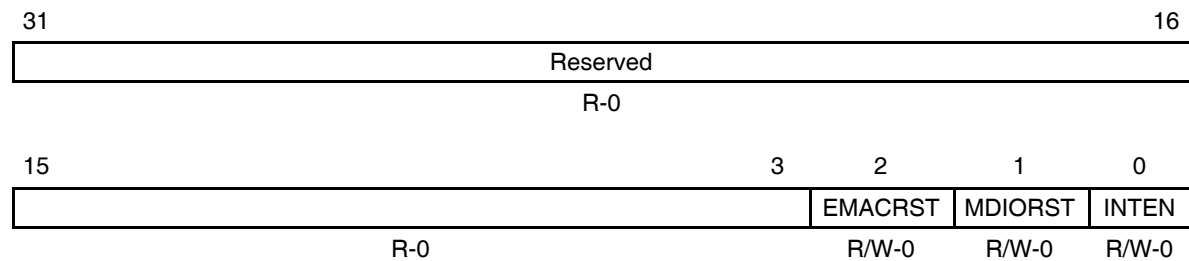

Legend: R = Read only; R/W = Read/Write; -n = value after reset

Table B–70. EMAC Control Module Interrupt Control Register (EWCTL) Field Values

Bit	field [†]	symval [†]	Value	Description
31–3	Reserved	–	0	Reserved. The reserved bit location is always read as 0. A value written to this field has no effect.
2	EMACRST			EMAC reset bit.
		NO	0	EMAC is not in reset.
		YES	1	EMAC is held in reset.
1	MDIORST			MDIO reset bit.
		NO	0	MDIO is not in reset.
		YES	1	MDIO is held in reset.
0	INTEN			EMAC and MDIO interrupt enable bit.
		DISABLE	0	EMAC and MDIO interrupts are disabled.
		ENABLE	1	EMAC and MDIO interrupts are enabled.

[†] For CSL implementation, use the notation EMAC_EWCTL_field_symval

B.4.3 EMAC Control Module Interrupt Timer Count Register (EWINTTCNT)

The EMAC control module interrupt timer count register (EWINTTCNT) is shown in Figure B–66 and described in Table B–71. EWINTTCNT is used to control the generation of back-to-back interrupts from the EMAC and MDIO modules. The value of this timer count is loaded into an internal counter every time interrupts are enabled using the EWCTL register. A second interrupt cannot be generated until this count reaches 0. The counter is decremented at a frequency of CPUclock/4; its default reset count is 0 (inactive), its maximum value is 1 FFFFh (131 071).

Figure B–66. EMAC Control Module Interrupt Timer Count Register (EWINTTCNT)

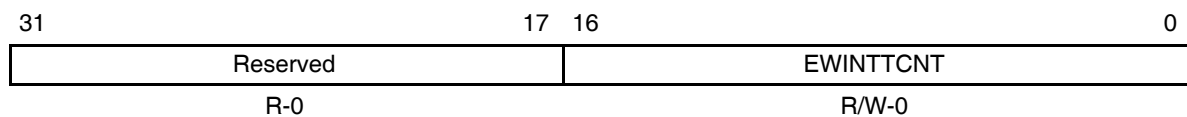

Legend: R = Read only; R/W = Read/Write; -n = value after reset

Table B–71. EMAC Control Module Interrupt Timer Count Register (EWINTTCNT)
Field Values

Bit	Field	symval [†]	Value	Description
31–17	Reserved	–	0	Reserved. The reserved bit location is always read as 0. A value written to this field has no effect.
16–0	EWINTTCNT		0–1 FFFFh	Interrupt timer count.

[†] For CSL implementation, use the notation EMAC_EWINTTCNT_EWINTTCNT_symval

B.5 EMAC Module Registers

Control registers for the EMAC module are summarized in Table B–72. See the device-specific datasheet for the memory address of these registers.

Table B–72. EMAC Module Registers

Acronym	Register Name	Section
TXIDVER	Transmit Identification and Version Register	B.5.1
TXCONTROL	Transmit Control Register	B.5.2
TXTEARDOWN	Transmit Teardown Register	B.5.3
RXIDVER	Receive Identification and Version Register	B.5.4
RXCONTROL	Receive Control Register	B.5.5
RXTEARDOWN	Receive Teardown Register	B.5.6
RXMBPENABLE	Receive Multicast/Broadcast/Promiscuous Channel Enable Register	B.5.7
RXUNICASTSET	Receive Unicast Set Register	B.5.8
RXUNICASTCLEAR	Receive Unicast Clear Register	B.5.9
RXMAXLEN	Receive Maximum Length Register	B.5.10
RXBUFFEROFFSET	Receive Buffer Offset Register	B.5.11
RXFILTERLOWTHRESH	Receive Filter Low Priority Packets Threshold Register	B.5.12
RX n FLOWTHRESH	Receive Channel 0–7 Flow Control Threshold Registers	B.5.13
RX n FREEBUFFER	Receive Channel 0–7 Free Buffer Count Registers	B.5.14
MACCONTROL	MAC Control Register	B.5.15
MACSTATUS	MAC Status Register	B.5.16
TXINTSTATRAW	Transmit Interrupt Status (Unmasked) Register	B.5.17
TXINTSTATMASKED	Transmit Interrupt Status (Masked) Register	B.5.18
TXINTMASKSET	Transmit Interrupt Mask Set Register	B.5.19
TXINTMASKCLEAR	Transmit Interrupt Mask Clear Register	B.5.20
MACINVECTOR	MAC Input Vector Register	B.5.21
RXINTSTATRAW	Receive Interrupt Status (Unmasked) Register	B.5.22
RXINTSTATMASKED	Receive Interrupt Status (Masked) Register	B.5.23
RXINTMASKSET	Receive Interrupt Mask Set Register	B.5.24
RXINTMASKCLEAR	Receive Interrupt Mask Clear Register	B.5.25

Table B-72. EMAC Module Registers (Continued)

Acronym	Register Name	Section
MACINTSTATRAW	MAC Interrupt Status (Unmasked) Register	B.5.26
MACINTSTATMASKED	MAC Interrupt Status (Masked) Register	B.5.27
MACINTMASKSET	MAC Interrupt Mask Set Register	B.5.28
MACINTMASKCLEAR	MAC Interrupt Mask Clear Register	B.5.29
MACADDRLn	MAC Address Channel 0–7 Lower Byte Register	B.5.30
MACADDRM	MAC Address Middle Byte Register	B.5.31
MACADDRH	MAC Address High Bytes Register	B.5.32
MACHASH1	MAC Address Hash 1 Register	B.5.33
MACHASH2	MAC Address Hash 2 Register	B.5.34
BOFFTEST	Backoff Test Register	B.5.35
TPACETEST	Transmit Pacing Test Register	B.5.36
RXPAUSE	Receive Pause Timer Register	B.5.37
TXPAUSE	Transmit Pause Timer Register	B.5.38
TXnHDP	Transmit Channel 0–7 DMA Head Descriptor Pointer Registers	B.5.39
RXnHDP	Receive Channel 0–7 DMA Head Descriptor Pointer Registers	B.5.40
TXnINTACK	Transmit Channel 0–7 Interrupt Acknowledge Registers	B.5.41
RXnINTACK	Receive Channel 0–7 Interrupt Acknowledge Registers	B.5.42
RXGOODFRAMES	Good Receive Frames Register	B.5.43
RXBCASTFRAMES	Broadcast Receive Frames Register	B.5.43
RXMCASTFRAMES	Multicast Receive Frames Register	B.5.43
RXPAUSEFRAMES	Pause Receive Frames Register	B.5.43
RXCRCERRORS	Receive CRC Errors Register	B.5.43
RXALIGNCODEERRORS	Receive Alignment/Code Errors Register	B.5.43
RXOVERSIZED	Receive Oversized Frames Register	B.5.43
RXJABBER	Receive Jabber Frames Register	B.5.43
RXUNDERSIZED	Receive Undersized Frames Register	B.5.43
RXFRAGMENTS	Receive Frame Fragments Register	B.5.43
RXFILTERED	Filtered Receive Frames Register	B.5.43

Table B–72. EMAC Module Registers (Continued)

Acronym	Register Name	Section
RXQOSFILTERED	Receive QOS Filtered Frames Register	B.5.43
RXOCTETS	Receive Octet Frames Register	B.5.43
RXSOFOVERRUNS	Receive Start of Frame Overruns Register	B.5.43
RXMOFOVERRUNS	Receive Middle of Frame Overruns Register	B.5.43
RXDMAOVERRUNS	Receive DMA Overruns Register	B.5.43
TXGOODFRAMES	Good Transmit Frames Register	B.5.43
TXBCASTFRAMES	Broadcast Transmit Frames Register	B.5.43
TXMCASTFRAMES	Multicast Transmit Frames Register	B.5.43
TXPAUSEFRAMES	Pause Transmit Frames Register	B.5.43
TXDEFERRED	Deferred Transmit Frames Register	B.5.43
TXCOLLISION	Collision Register	B.5.43
TXSINGLECOLL	Single Collision Transmit Frames Register	B.5.43
TXMULTICOLL	Multiple Collision Transmit Frames Register	B.5.43
TXEXCESSIVECOLL	Excessive Collisions Register	B.5.43
TXLATECOLL	Late Collisions Register	B.5.43
TXUNDERRUN	Transmit Underrun Register	B.5.43
TXCARRIERSLOSS	Transmit Carrier Sense Errors Register	B.5.43
TXOCTETS	Transmit Octet Frames Register	B.5.43
FRAME64	Transmit and Receive 64 Octet Frames Register	B.5.43
FRAME65T127	Transmit and Receive 65 to 127 Octet Frames Register	B.5.43
FRAME128T255	Transmit and Receive 128 to 255 Octet Frames Register	B.5.43
FRAME256T511	Transmit and Receive 256 to 511 Octet Frames Register	B.5.43
FRAME512T1023	Transmit and Receive 512 to 1023 Octet Frames Register	B.5.43
FRAME1024TUP	Transmit and Receive 1024 or Above Octet Frames Register	B.5.43
NETOCTETS	Network Octet Frames Register	B.5.43

B.5.1 Transmit Identification and Version Register (TXIDVER)

The transmit identification and version register (TXIDVER) is shown in Figure B–67 and described in Table B–73.

Figure B–67. Transmit Identification and Version Register (TXIDVER)

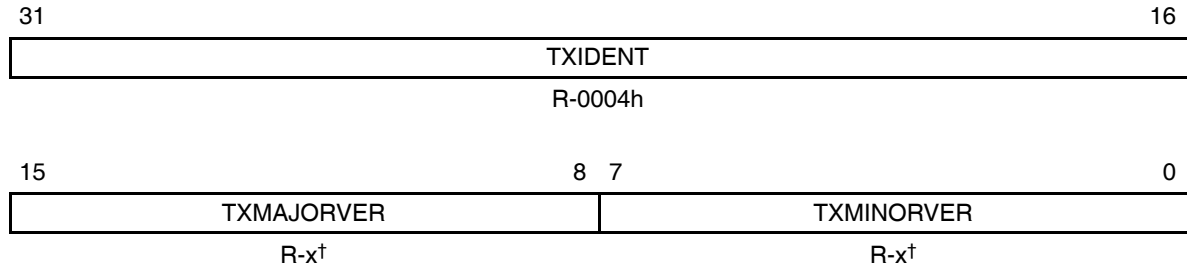

Legend: R = Read only; -n = value after reset

† See the device-specific datasheet for the default value of this field.

Table B–73. Transmit Identification and Version Register (TXIDVER) Field Values

Bit	field†	symval†	Value	Description
31–16	TXIDENT		4h	Transmit identification value bits. EMAC
15–8	TXMAJORVER		x	Transmit major version value is the major version number. See the device-specific datasheet for the value.
7–0	TXMINORVER		x	Transmit minor version value is the minor version number. See the device-specific datasheet for the value.

† For CSL implementation, use the notation EMAC_TXIDVER_field_symval

B.5.2 Transmit Control Register (TXCONTROL)

The transmit control register (TXCONTROL) is shown in Figure B–68 and described in Table B–74.

Figure B–68. Transmit Control Register (TXCONTROL)

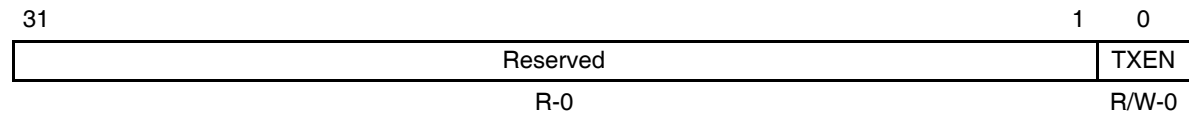

Legend: R = Read only; R/W = Read/Write; -n = value after reset

Table B–74. Transmit Control Register (TXCONTROL) Field Values

Bit	Field	symval [†]	Value	Description
31–1	Reserved	–	0	Reserved. The reserved bit location is always read as 0. A value written to this field has no effect.
0	TXEN			Transmit enable bit.
		DISABLE	0	Transmit is disabled.
		ENABLE	1	Transmit is enabled.

[†] For CSL implementation, use the notation EMAC_TXCONTROL_TXEN_symval

B.5.3 Transmit Teardown Register (TXTEARDOWN)

The transmit teardown register (TXTEARDOWN) is shown in Figure B–69 and described in Table B–75.

Figure B–69. Transmit Teardown Register (TXTEARDOWN)

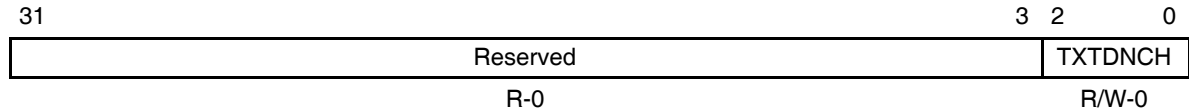

Legend: R = Read only; R/W = Read/Write; -n = value after reset

Table B–75. Transmit Teardown Register (TXTEARDOWN) Field Values

Bit	Field	symval [†]	Value	Description
31–3	Reserved	–	0	Reserved. The reserved bit location is always read as 0. A value written to this field has no effect.
2–0	TXTDNCH		0–7h	Transmit teardown channel bits determine the transmit channel to be torn down. The teardown register is read as 0.
			0	Teardown transmit channel 0.
			1h	Teardown transmit channel 1.
			2h	Teardown transmit channel 2.
			3h	Teardown transmit channel 3.
			4h	Teardown transmit channel 4.
			5h	Teardown transmit channel 5.
			6h	Teardown transmit channel 6.
			7h	Teardown transmit channel 7.

[†] For CSL implementation, use the notation EMAC_TXTEARDOWN_TXTDNCH_symval

B.5.4 Receive Identification and Version Register (RXIDVER)

The receive identification and version register (RXIDVER) is shown in Figure B–70 and described in Table B–76.

Figure B–70. Receive Identification and Version Register (RXIDVER)

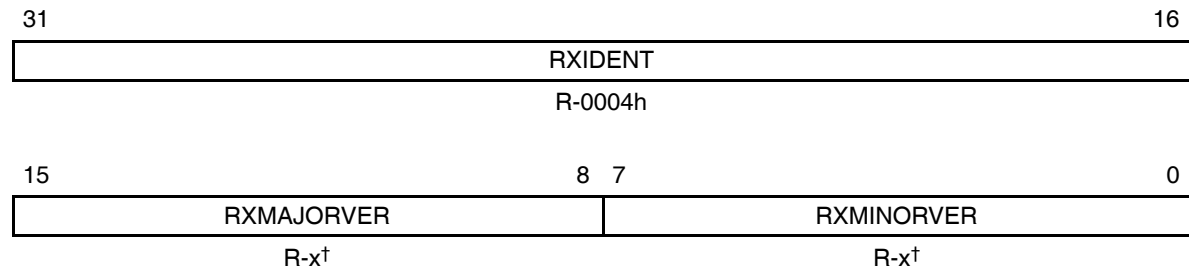

Legend: R = Read only; -n = value after reset

† See the device-specific datasheet for the default value of this field.

Table B–76. Receive Identification and Version Register (RXIDVER) Field Values

Bit	field†	symval†	Value	Description
31–16	RXIDENT		4h	Receive identification value bits. EMAC
15–8	RXMAJORVER		x	Receive major version value is the major version number. See the device-specific datasheet for the value.
7–0	RXMINORVER		x	Receive minor version value is the minor version number. See the device-specific datasheet for the value.

† For CSL implementation, use the notation EMAC_RXIDVER_field_symval

B.5.5 Receive Control Register (RXCONTROL)

The receive control register (RXCONTROL) is shown in Figure B-71 and described in Table B-77.

Figure B-71. Receive Control Register (RXCONTROL)

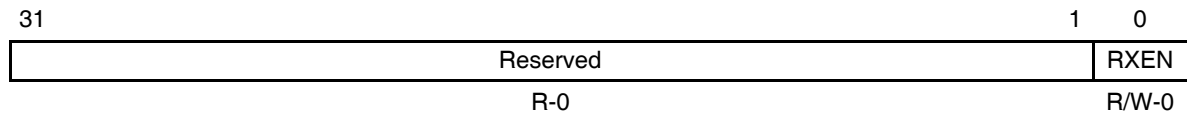

Legend: R = Read only; R/W = Read/Write; -n = value after reset

Table B-77. Receive Control Register (RXCONTROL) Field Values

Bit	Field	symval [†]	Value	Description
31-1	Reserved	-	0	Reserved. The reserved bit location is always read as 0. A value written to this field has no effect.
0	RXEN			Receive DMA enable bit.
		DISABLE	0	Receive is disabled.
		ENABLE	1	Receive is enabled.

[†] For CSL implementation, use the notation EMAC_RXCONTROL_RXEN_symval

B.5.6 Receive Teardown Register (RXTEARDOWN)

The receive teardown register (RXTEARDOWN) is shown in Figure B–72 and described in Table B–78.

Figure B–72. Receive Teardown Register (RXTEARDOWN)

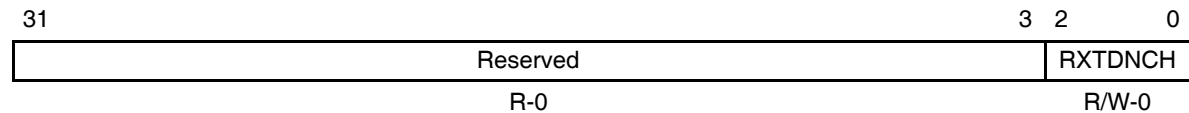

Legend: R = Read only; R/W = Read/Write; -n = value after reset

Table B–78. Receive Teardown Register (RXTEARDOWN) Field Values

Bit	Field	symval [†]	Value	Description
31–3	Reserved	–	0	Reserved. The reserved bit location is always read as 0. A value written to this field has no effect.
2–0	RXTDNCH		0–7h	Receive teardown channel bits determine the receive channel to be torn down. The teardown register is read as 0.
			0	Teardown receive channel 0.
			1h	Teardown receive channel 1.
			2h	Teardown receive channel 2.
			3h	Teardown receive channel 3.
			4h	Teardown receive channel 4.
			5h	Teardown receive channel 5.
			6h	Teardown receive channel 6.
			7h	Teardown receive channel 7.

[†] For CSL implementation, use the notation EMAC_RXTEARDOWN_RXTDNCH_symval

B.5.7 Receive Multicast/Broadcast/Promiscuous Channel Enable Register (RXMBPENABLE)

The receive multicast/broadcast/promiscuous channel enable register (RXMBPENABLE) is shown in Figure B–73 and described in Table B–79.

Figure B–73. Receive Multicast/Broadcast/Promiscuous Channel Enable Register (RXMBPENABLE)

31	30	29	28	27	25	24
Reserved	RXPASSCRC	RXQOSEN	RXNOCHAIN	Reserved		RXCMFEN
R-0	R/W-0	R/W-0	R/W-0	R-0		R/W-0
23	22	21	20	19	18	16
RXCSFEN	RXCEFEN	RXCAFEN	Reserved		PROMCH	
R/W-0	R/W-0	R/W-0	R-0		R/W-0	
15	14	13	12	11	10	8
Reserved		BROADEN	Reserved		BROADCH	
R-0		R/W-0	R-0		R/W-0	
7	6	5	4	3	2	0
Reserved		MULTEN	Reserved		MULTCH	
R-0		R/W-0	R-0		R/W-0	

Legend: R = Read only; R/W = Read/Write; -n = value after reset

Table B–79. Receive Multicast/Broadcast/Promiscuous Channel Enable Register (RXMBPENABLE) Field Values

Bit	field [†]	symval [†]	Value	Description
31	Reserved	–	0	Reserved. The reserved bit location is always read as 0. A value written to this field has no effect.
30	RXPASSCRC			Pass received CRC enable bit.
		DISCARD	0	Received CRC is discarded for all channels and is not included in the buffer descriptor packet length field.
		INCLUDE	1	Received CRC is transferred to memory for all channels and is included in the buffer descriptor packet length.

[†] For CSL implementation, use the notation EMAC_RXMBPENABLE_field_symval

Table B–79. Receive Multicast/Broadcast/Promiscuous Channel Enable Register (RXMBPENABLE) Field Values (Continued)

Bit	field [†]	symval [†]	Value	Description
29	RXQOSEN			Receive quality of service (QOS) enable bit.
		DISABLE	0	Receive QOS is disabled.
		ENABLE	1	Receive QOS is enabled.
28	RXNOCHAIN			Receive no buffer chaining bit.
		DISABLE	0	Received frames can span multiple buffers.
		ENABLE	1	Receive DMA controller transfers each frame into a single buffer regardless of the frame or buffer size. All remaining frame data after the first buffer is discarded.
27–25	Reserved	–	0	Reserved. The reserved bit location is always read as 0. A value written to this field has no effect.
24	RXCMFEN			Receive copy MAC control frames enable bit. Enables MAC control frames to be transferred to memory. MAC control frames are normally acted upon (if enabled), but not copied to memory. MAC control frames that are pause frames will be acted upon if enabled in MACCONTROL, regardless of the value of RXCMFEN. Frames transferred to memory due to RXCMFEN will have the control bit set in their EOP buffer descriptor.
		DISABLE	0	MAC control frames are filtered (but acted upon if enabled).
		ENABLE	1	MAC control frames are transferred to memory.
23	RXCSFEN			Receive copy short frames enable bit. Enables frames or fragments shorter than 64 bytes to be copied to memory. Frames transferred to memory due to RXCSFEN will have the fragment or undersized bit set in their EOP buffer descriptor. Fragments are short frames that contain CRC/align/code errors and undersized are short frames without errors.
		DISABLE	0	Short frames are filtered.
		ENABLE	1	Short frames are transferred to memory.

[†] For CSL implementation, use the notation EMAC_RXMBPENABLE_field_symval

Table B–79. Receive Multicast/Broadcast/Promiscuous Channel Enable Register (RXMBPENABLE) Field Values (Continued)

Bit	field [†]	symval [†]	Value	Description
22	RXCEFEN			Receive copy error frames enable bit. Enables frames containing errors to be transferred to memory. The appropriate error bit will be set in the frame EOP buffer descriptor.
		DISABLE	0	Frames containing errors are filtered.
		ENABLE	1	Frames containing errors are transferred to memory.
21	RXCAFEN			Receive copy all frames enable bit. Enables frames that do not address match (includes multicast frames that do not hash match) to be transferred to the promiscuous channel selected by PROMCH bits. Such frames will be marked with the no_match bit in their EOP buffer descriptor.
		DISABLE	0	
		ENABLE	1	Frames that do not address match (includes multicast frames that do not hash match) are transferred to the promiscuous channel selected by PROMCH bits.
20–19	Reserved	–	0	Reserved. The reserved bit location is always read as 0. A value written to this field has no effect.
18–16	PROMCH		0–7h	Receive promiscuous channel select bits.
			0	Select channel 0 to receive promiscuous frames.
			1h	Select channel 1 to receive promiscuous frames.
			2h	Select channel 2 to receive promiscuous frames.
			3h	Select channel 3 to receive promiscuous frames.
			4h	Select channel 4 to receive promiscuous frames.
			5h	Select channel 5 to receive promiscuous frames.
			6h	Select channel 6 to receive promiscuous frames.
			7h	Select channel 7 to receive promiscuous frames.
15–14	Reserved	–	0	Reserved. The reserved bit location is always read as 0. A value written to this field has no effect.

[†] For CSL implementation, use the notation EMAC_RXMBPENABLE_field_symval

Table B–79. Receive Multicast/Broadcast/Promiscuous Channel Enable Register (RXMBPENABLE) Field Values (Continued)

Bit	field [†]	symval [†]	Value	Description
13	BROADEN			Receive broadcast enable bit. Enable received broadcast frames to be copied to the channel selected by BROADCH bits.
		DISABLE	0	Broadcast frames are filtered.
		ENABLE	1	Broadcast frames are copied to the channel selected by BROADCH bits.
12–11	Reserved	–	0	Reserved. The reserved bit location is always read as 0. A value written to this field has no effect.
10–8	BROADCH		0–7h	Receive broadcast channel select bits. Selects the receive channel for reception of all broadcast frames when enabled by BROADEN bit.
			0	Select channel 0 to receive broadcast frames.
			1h	Select channel 1 to receive broadcast frames.
			2h	Select channel 2 to receive broadcast frames.
			3h	Select channel 3 to receive broadcast frames.
			4h	Select channel 4 to receive broadcast frames.
			5h	Select channel 5 to receive broadcast frames.
			6h	Select channel 6 to receive broadcast frames.
	7h	Select channel 7 to receive broadcast frames.		
7–6	Reserved	–	0	Reserved. The reserved bit location is always read as 0. A value written to this field has no effect.
5	MULTEN			Receive multicast enable bit. Enable received hash matching multicast frames to be copied to the channel selected by MULTCH bits.
		DISABLE	0	Multicast (group addressed) frames are filtered.
		ENABLE	1	Multicast frames are copied to the channel selected by MULTCH bits.

[†] For CSL implementation, use the notation EMAC_RXMBPENABLE_field_symval

Table B–79. Receive Multicast/Broadcast/Promiscuous Channel Enable Register (RXMBPENABLE) Field Values (Continued)

Bit	field [†]	symval [†]	Value	Description
4–3	Reserved	–	0	Reserved. The reserved bit location is always read as 0. A value written to this field has no effect.
2–0	MULTCH		0–7h	Receive multicast channel select bits selects the receive channel for reception of all hash matching multicast frames when enabled by MULTEN bit.
			0	Select channel 0 to receive hash matching multicast frames.
			1h	Select channel 1 to receive hash matching multicast frames.
			2h	Select channel 2 to receive hash matching multicast frames.
			3h	Select channel 3 to receive hash matching multicast frames.
			4h	Select channel 4 to receive hash matching multicast frames.
			5h	Select channel 5 to receive hash matching multicast frames.
			6h	Select channel 6 to receive hash matching multicast frames.
			7h	Select channel 7 to receive hash matching multicast frames.

[†] For CSL implementation, use the notation EMAC_RXMBPENABLE_field_symval

B.5.8 Receive Unicast Set Register (RXUNICASTSET)

The receive unicast set register (RXUNICASTSET) is shown in Figure B–74 and described in Table B–80.

Each unicast channel is disabled by a write to the corresponding MACADDR L_n , regardless of the setting of the corresponding bit in RXUNICASTCLEAR. Each unicast channel is enabled by a write to the MACADDR R_n , if the corresponding bit in RXUNICASTCLEAR is set. Reading the RXUNICASTCLEAR address returns the actual value of the unicast enable register. Reading the RXUNICASTSET address returns the value of the unicast enable register after gating with the MAC address logic.

Figure B–74. Receive Unicast Set Register (RXUNICASTSET)

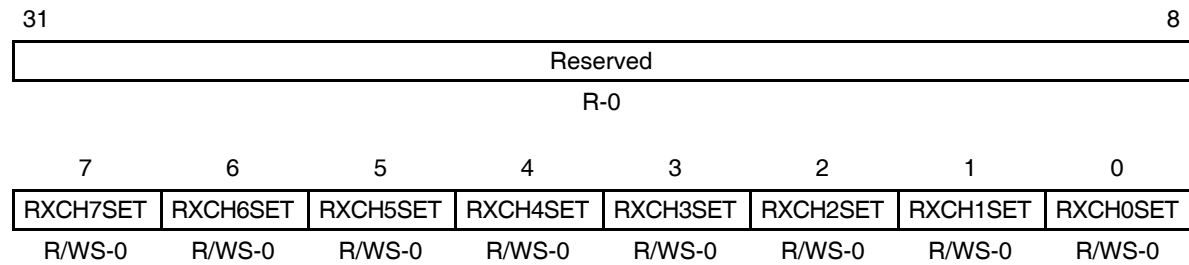

Legend: R = Read only; WS = Write 1 to set, write of 0 has no effect; -n = value after reset

Table B–80. Receive Unicast Set Register (RXUNICASTSET)
Field Values

Bit	field [†]	symval [†]	Value	Description
31–8	Reserved	–	0	Reserved. The reserved bit location is always read as 0. A value written to this field has no effect.
7	RXCH7SET		0	No effect.
			1	Sets receive channel 7 unicast enable.
6	RXCH6SET		0	No effect.
			1	Sets receive channel 6 unicast enable.

[†] For CSL implementation, use the notation EMAC_RXUNICASTSET_field_symval

**Table B–80. Receive Unicast Set Register (RXUNICASTSET)
Field Values (Continued)**

Bit	field [†]	symval [†]	Value	Description
5	RXCH5SET			Receive channel 5 unicast enable set bit. Write 1 to set the enable, a write of 0 has no effect.
			0	No effect.
			1	Sets receive channel 5 unicast enable.
4	RXCH4SET			Receive channel 4 unicast enable set bit. Write 1 to set the enable, a write of 0 has no effect.
			0	No effect.
			1	Sets receive channel 4 unicast enable.
3	RXCH3SET			Receive channel 3 unicast enable set bit. Write 1 to set the enable, a write of 0 has no effect.
			0	No effect.
			1	Sets receive channel 3 unicast enable.
2	RXCH2SET			Receive channel 2 unicast enable set bit. Write 1 to set the enable, a write of 0 has no effect.
			0	No effect.
			1	Sets receive channel 2 unicast enable.
1	RXCH1SET			Receive channel 1 unicast enable set bit. Write 1 to set the enable, a write of 0 has no effect.
			0	No effect.
			1	Sets receive channel 1 unicast enable.
0	RXCH0SET			Receive channel 0 unicast enable set bit. Write 1 to set the enable, a write of 0 has no effect.
			0	No effect.
			1	Sets receive channel 0 unicast enable.

[†] For CSL implementation, use the notation `EMAC_RXUNICASTSET_field_symval`

B.5.9 Receive Unicast Clear Register (RXUNICASTCLEAR)

The receive unicast clear register (RXUNICASTCLEAR) is shown in Figure B–75 and described in Table B–81.

Each unicast channel is disabled by a write to the corresponding MACADDR L_n , regardless of the setting of the corresponding bit in RXUNICASTCLEAR. Each unicast channel is enabled by a write to the MACADDR R_n , if the corresponding bit in RXUNICASTCLEAR is set. Reading the RXUNICASTCLEAR address returns the actual value of the unicast enable register. Reading the RXUNICASTSET address returns the value of the unicast enable register after gating with the MAC address logic.

Figure B–75. Receive Unicast Clear Register (RXUNICASTCLEAR)

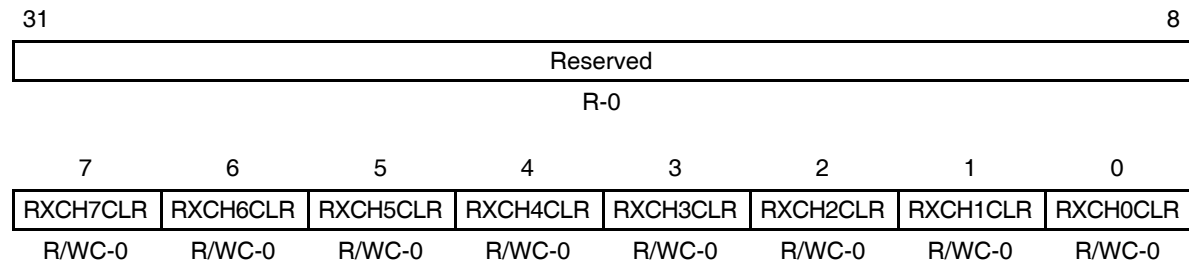

Legend: R = Read only; WC = Write 1 to clear, write of 0 has no effect; - n = value after reset

Table B–81. Receive Unicast Clear Register (RXUNICASTCLEAR)
Field Values

Bit	field [†]	symval [†]	Value	Description
31–8	Reserved	–	0	Reserved. The reserved bit location is always read as 0. A value written to this field has no effect.
7	RXCH7CLR		0	No effect.
			1	Clears receive channel 7 unicast enable.
6	RXCH6CLR		0	No effect.
			1	Clears receive channel 6 unicast enable.

[†] For CSL implementation, use the notation EMAC_RXUNICASTCLEAR_field_symval

**Table B–81. Receive Unicast Clear Register (RXUNICASTCLEAR)
Field Values (Continued)**

Bit	field [†]	symval [†]	Value	Description
5	RXCH5CLR			Receive channel 5 unicast enable clear bit. Write 1 to clear the enable, a write of 0 has no effect.
			0	No effect.
			1	Clears receive channel 5 unicast enable.
4	RXCH4CLR			Receive channel 4 unicast enable clear bit. Write 1 to clear the enable, a write of 0 has no effect.
			0	No effect.
			1	Clears receive channel 4 unicast enable.
3	RXCH3CLR			Receive channel 3 unicast enable clear bit. Write 1 to clear the enable, a write of 0 has no effect.
			0	No effect.
			1	Clears receive channel 3 unicast enable.
2	RXCH2CLR			Receive channel 2 unicast enable clear bit. Write 1 to clear the enable, a write of 0 has no effect.
			0	No effect.
			1	Clears receive channel 2 unicast enable.
1	RXCH1CLR			Receive channel 1 unicast enable clear bit. Write 1 to clear the enable, a write of 0 has no effect.
			0	No effect.
			1	Clears receive channel 1 unicast enable.
0	RXCH0CLR			Receive channel 0 unicast enable clear bit. Write 1 to clear the enable, a write of 0 has no effect.
			0	No effect.
			1	Clears receive channel 0 unicast enable.

[†] For CSL implementation, use the notation `EMAC_RXUNICASTCLEAR_field_symval`

B.5.10 Receive Maximum Length Register (RXMAXLEN)

The receive maximum length register (RXMAXLEN) is shown in Figure B–76 and described in Table B–82.

Figure B–76. Receive Maximum Length Register (RXMAXLEN)

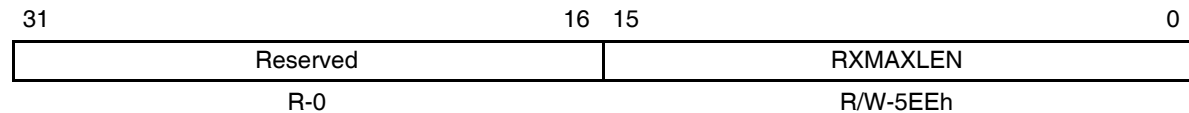

Legend: R = Read only; R/W = Read/Write; -n = value after reset

Table B–82. Receive Maximum Length Register (RXMAXLEN) Field Values

Bit	Field	symval [†]	Value	Description
31–16	Reserved	–	0	Reserved. The reserved bit location is always read as 0. A value written to this field has no effect.
15–0	RXMAXLEN		0–FFFFh	Received maximum frame length bits determine the maximum length of a received frame. The reset value is 5EEh (1518). Frames with byte counts greater than RXMAXLEN are long frames. Long frames with no errors are oversized frames. Long frames with CRC, code, or alignment error are jabber frames.

[†] For CSL implementation, use the notation EMAC_RXMAXLEN_RXMAXLEN_symval

B.5.11 Receive Buffer Offset Register (RXBUFFEROFFSET)

The receive buffer offset register (RXBUFFEROFFSET) is shown in Figure B-77 and described in Table B-83.

Figure B-77. Receive Buffer Offset Register (RXBUFFEROFFSET)

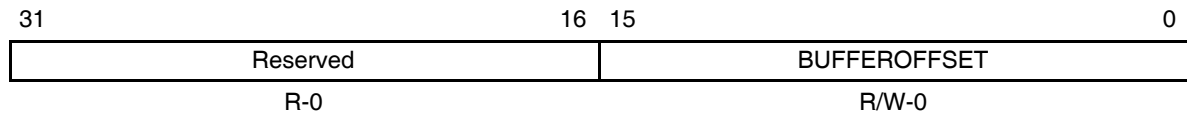

Legend: R = Read only; R/W = Read/Write; -n = value after reset

Table B-83. Receive Buffer Offset Register (RXBUFFEROFFSET) Field Values

Bit	Field	symval [†]	Value	Description
31-16	Reserved	-	0	Reserved. The reserved bit location is always read as 0. A value written to this field has no effect.
15-0	BUFFEROFFSET		0-FFFFh	Receive buffer offset bits are written by the EMAC into each frame SOP buffer descriptor Buffer Offset field. The frame data begins after the BUFFEROFFSET value of bytes. A value of 0 indicates that there are no unused bytes at the beginning of the data and that valid data begins on the first byte of the buffer. A value of Fh indicates that the first 15 bytes of the buffer are to be ignored by the EMAC and that valid buffer data starts on byte 16 of the buffer. This value is used for all channels.

[†] For CSL implementation, use the notation EMAC_RXBUFFEROFFSET_BUFFEROFFSET_symval

B.5.12 Receive Filter Low Priority Packets Threshold Register (RXFILTERLOWTHRESH)

The receive filter low priority packets threshold register (RXFILTERLOWTHRESH) is shown in Figure B–78 and described in Table B–84.

Figure B–78. Receive Filter Low Priority Packets Threshold Register (RXFILTERLOWTHRESH)

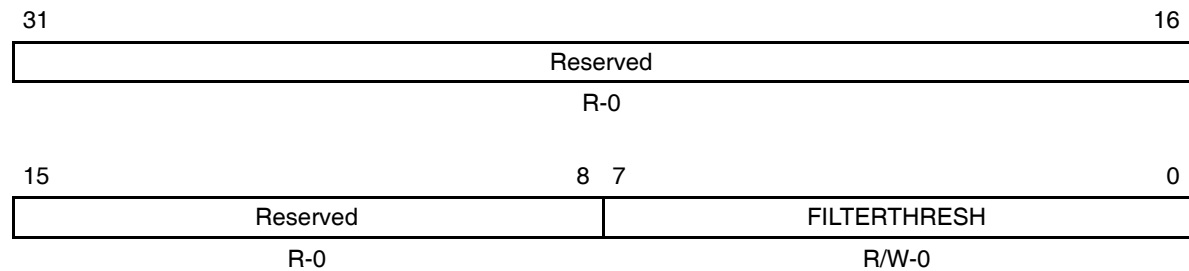

Legend: R = Read only; R/W = Read/Write; -n = value after reset

Table B–84. Receive Filter Low Priority Packets Threshold Register (RXFILTERLOWTHRESH) Field Values

Bit	Field	symval [†]	Value	Description
31–8	Reserved	–	0	Reserved. The reserved bit location is always read as 0. A value written to this field has no effect.
7–0	FILTERTHRESH		0–FFh	Receive filter low threshold bits contain the free buffer count threshold value for filtering low priority incoming frames. This field should remain zero, if no filtering is desired.

[†] For CSL implementation, use the notation EMAC_RXFILTERLOWTHRESH_FILTERTHRESH_symval

B.5.13 Receive Channel 0–7 Flow Control Threshold Registers (RX n FLOWTHRESH)

The receive channel n flow control threshold registers (RX n FLOWTHRESH) is shown in Figure B–79 and described in Table B–85.

Figure B–79. Receive Channel n Flow Control Threshold Registers (RX n FLOWTHRESH)

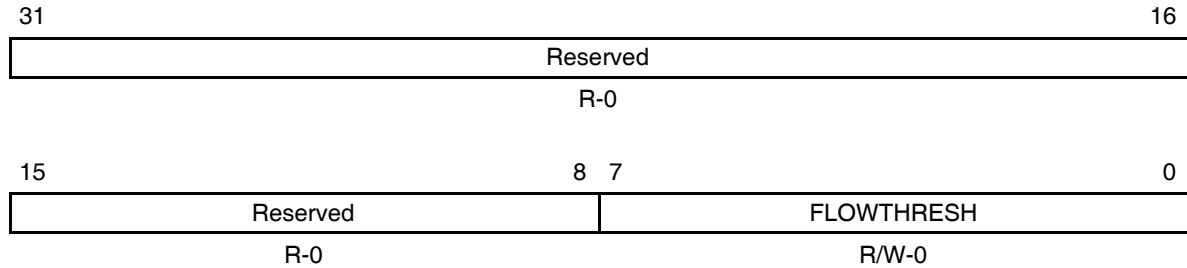

Legend: R = Read only; R/W = Read/Write; - n = value after reset

Table B–85. Receive Channel n Flow Control Threshold Registers (RX n FLOWTHRESH) Field Values

Bit	Field	<i>symval</i> [†]	Value	Description
31–8	Reserved	–	0	Reserved. The reserved bit location is always read as 0. A value written to this field has no effect.
7–0	FLOWTHRESH		0–FFh	Receive flow threshold bits contain the threshold value for issuing flow control on incoming frames (when enabled).

[†] For CSL implementation, use the notation EMAC_RX n FLOWTHRESH_FLOWTHRESH_*symval*

B.5.14 Receive Channel 0–7 Free Buffer Count Registers (RXnFREEBUFFER)

The receive channel n free buffer count registers (RXnFREEBUFFER) is shown in Figure B–80 and described in Table B–86.

Figure B–80. Receive Channel n Free Buffer Count Registers (RXnFREEBUFFER)

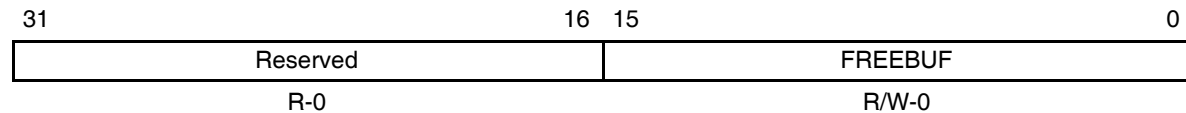

Legend: R = Read only; R/W = Read/Write; $-n$ = value after reset

Table B–86. Receive Channel n Free Buffer Count Registers (RXnFREEBUFFER)
Field Values

Bit	Field	symval [†]	Value	Description
31–16	Reserved	–	0	Reserved. The reserved bit location is always read as 0. A value written to this field has no effect.
15–0	FREEBUF		0–FFFFh	Receive free buffer count bits contain the count of free buffers available. The RXFILTERLOWTHRESH value is compared with this field to determine if low priority frames should be filtered. The RXnFLOWTHRESH value is compared with this field to determine if receive flow control should be issued against incoming packets (if enabled). This is a write-to-increment field. This field rolls over to zero on overflow. If hardware flow control or QOS is used, the host must initialize this field to the number of available buffers (one register per channel). The EMAC decrements (by the number of buffers in the received frame) the associated channel register for each received frame. This is a write-to-increment field. The host must write this field with the number of buffers that have been freed due to host processing.

[†] For CSL implementation, use the notation EMAC_RXnFREEBUFFER_FREEBUF_symval

B.5.15 MAC Control Register (MACCONTROL)

The MAC control register (MACCONTROL) is shown in Figure B–81 and described in Table B–87.

Figure B–81. MAC Control Register (MACCONTROL)

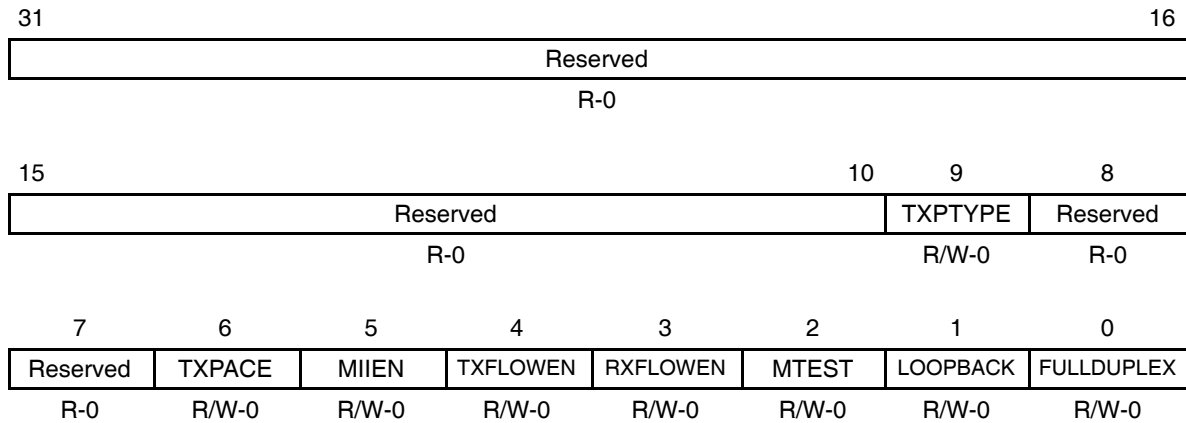

Legend: R = Read only; R/W = Read/Write; -n = value after reset

Table B–87. MAC Control Register (MACCONTROL) Field Values

Bit	field [†]	symval [†]	Value	Description
31–10	Reserved	–	0	Reserved. The reserved bit location is always read as 0. A value written to this field has no effect.
9	TXPTYPE	RROBIN	0	The queue uses a round-robin scheme to select the next channel for transmission.
		CHANNELPRI	1	The queue uses a fixed-priority (channel 7 highest priority) scheme to select the next channel for transmission.
8–7	Reserved	–	0	Reserved. The reserved bit location is always read as 0. A value written to this field has no effect.
6	TXPACE			Transmit pacing enable bit.
		DISABLE	0	Transmit pacing is disabled.
		ENABLE	1	Transmit pacing is enabled.

[†] For CSL implementation, use the notation EMAC_MACCONTROL_field_symval

Table B–87. MAC Control Register (MACCONTROL) Field Values (Continued)

Bit	field [†]	symval [†]	Value	Description
5	MIIEN			MII enable bit.
		DISABLE	0	MII receive and transmit are disabled (state machine reset).
		ENABLE	1	MII receive and transmit are enabled.
4	TXFLOWEN			Transmit flow control enable bit determines if incoming pause frames are acted upon in full-duplex mode. Incoming pause frames are not acted upon in half-duplex mode, regardless of this bit setting. The RXMBPENABLE bits determine whether or not received pause frames are transferred to memory.
		DISABLE	0	Transmit flow control is disabled. Full-duplex mode: incoming pause frames are not acted upon.
		ENABLE	1	Transmit flow control is enabled. Full-duplex mode: incoming pause frames are acted upon.
3	RXFLOWEN			Receive flow control enable bit.
		DISABLE	0	Receive flow control is disabled. Half-duplex mode: no flow control generated collisions are sent. Full-duplex mode: no outgoing pause frames are sent.
		ENABLE	1	Receive flow control is enabled. Half-duplex mode: collisions are initiated when receive flow control is triggered. Full-duplex mode: outgoing pause frames are sent when receive flow control is triggered.
2	MTEST			Manufacturing test mode bit.
		DISABLE	0	Writes to the BOFFTEST, RXPAUSE, and TXPAUSE registers are disabled.
		ENABLE	1	Writes to the BOFFTEST, RXPAUSE, and TXPAUSE registers are enabled.
1	LOOPBACK			Loopback mode enable bit. Loopback mode forces internal full-duplex mode regardless of the FULLDUPLEX bit. The loopback bit should be changed only when MIIEN bit is deasserted.
		DISABLE	0	Loopback mode is disabled.
		ENABLE	1	Loopback mode is enabled.

[†] For CSL implementation, use the notation EMAC_MACCONTROL_field_symval

Table B–87. MAC Control Register (MACCONTROL) Field Values (Continued)

Bit	field [†]	symval [†]	Value	Description
0	FULLDUPLEX			Full-duplex mode enable bit.
		DISABLE	0	Half-duplex mode is enabled.
		ENABLE	1	Full-duplex mode is enabled.

[†] For CSL implementation, use the notation EMAC_MACCONTROL_field_symval

B.5.16 MAC Status Register (MACSTATUS)

The MAC status register (MACSTATUS) is shown in Figure B–82 and described in Table B–88.

Figure B–82. MAC Status Register (MACSTATUS)

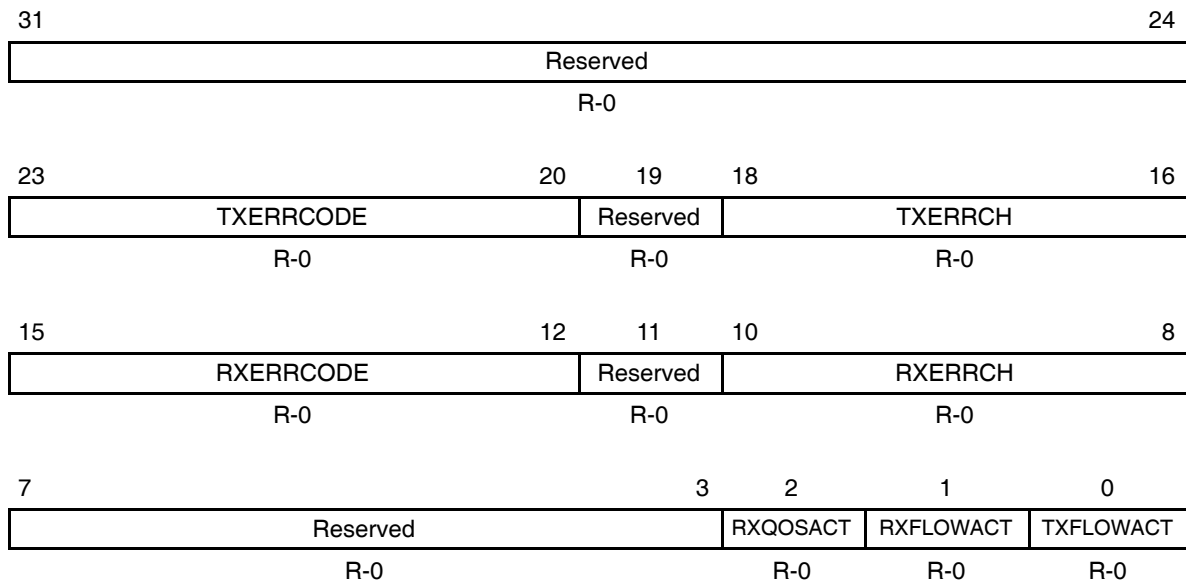

Legend: R = Read only; -n = value after reset

Table B–88. MAC Status Register (MACSTATUS) Field Values

Bit	field [†]	symval [†]	Value	Description
31–24	Reserved	–	0	Reserved. The reserved bit location is always read as 0. A value written to this field has no effect.
23–20	TXERRCODE		0–Fh	Transmit host error code bits indicate EMAC detected transmit DMA related host errors. The host should read this field after a host error interrupt (HOSTERRINT) to determine the error. Host error interrupts require hardware reset in order to recover.
		NOERROR	0	No error
		SOPERROR	1h	SOP error
		OWNERSHIP	2h	Ownership bit is not set in SOP buffer
		NOEOP	3h	Zero next buffer descriptor pointer is without EOP
		NULLPTR	4h	Zero buffer pointer
		NULLEN	5h	Zero buffer length
		LENRRROR	6h	Packet length error
		–	7h–Fh	Reserved
19	Reserved	–	0	Reserved. The reserved bit location is always read as 0. A value written to this field has no effect.
18–16	TXERRCH		0–7h	Transmit host error channel bits indicate which transmit channel the host error occurred on. This field is cleared to 0 on a host read.
		DEFAULT	0	The host error occurred on transmit channel 0.
			1h	The host error occurred on transmit channel 1.
			2h	The host error occurred on transmit channel 2.
			3h	The host error occurred on transmit channel 3.
			4h	The host error occurred on transmit channel 4.
			5h	The host error occurred on transmit channel 5.
			6h	The host error occurred on transmit channel 6.
			7h	The host error occurred on transmit channel 7.

[†] For CSL implementation, use the notation EMAC_MACSTATUS_field_symval

Table B–88. MAC Status Register (MACSTATUS) Field Values (Continued)

Bit	field [†]	symval [†]	Value	Description
15–12	RXERRCODE		0–Fh	Receive host error code bits indicate EMAC detected receive DMA related host errors. The host should read this field after a host error interrupt (HOSTERRINT) to determine the error. Host error interrupts require hardware reset in order to recover.
		NOERROR	0	No error
		SOPERROR	1h	SOP error
		OWNERSHIP	2h	Ownership bit is not set in input buffer
		NOEOP	3h	Zero next buffer descriptor pointer is without eop
		NULLPTR	4h	Zero buffer pointer
		NULLEN	5h	Zero buffer length
		LENRRROR	6h	Packet length error
		–	7h–Fh	Reserved
11	Reserved	–	0	Reserved. The reserved bit location is always read as 0. A value written to this field has no effect.
10–8	RXERRCH		0–7h	Receive host error channel bits indicate which receive channel the host error occurred on. This field is cleared to 0 on a host read.
		DEFAULT	0	The host error occurred on receive channel 0.
			1h	The host error occurred on receive channel 1.
			2h	The host error occurred on receive channel 2.
			3h	The host error occurred on receive channel 3.
			4h	The host error occurred on receive channel 4.
			5h	The host error occurred on receive channel 5.
			6h	The host error occurred on receive channel 6.
			7h	The host error occurred on receive channel 7.
7–3	Reserved	–	0	Reserved. The reserved bit location is always read as 0. A value written to this field has no effect.

[†] For CSL implementation, use the notation EMAC_MACSTATUS_field_symval

Table B–88. MAC Status Register (MACSTATUS) Field Values (Continued)

Bit	field [†]	symval [†]	Value	Description
2	RXQOSACT			Receive quality of service (QOS) active bit.
		DEFAULT	0	Receive quality of service is disabled.
			1	Receive quality of service is enabled and that at least one channel freebuffer count (RXnFREEBUFFER) value is less than or equal to the RXFILTERLOWTHRESH value.
1	RXFLOWACT			Receive flow control active bit.
		DEFAULT	0	
			1	At least one channel freebuffer count (RXnFREEBUFFER) value is less than or equal to the channel's corresponding RXnFLOWTHRESH value.
0	TXFLOWACT			Transmit flow control active bit.
		DEFAULT	0	
			1	The pause time period is being observed for a received pause frame. No new transmissions begin while this bit is asserted except for the transmission of pause frames. Any transmission in progress when this bit is asserted will complete.

[†] For CSL implementation, use the notation EMAC_MACSTATUS_field_symval

B.5.17 Transmit Interrupt Status (Unmasked) Register (TXINTSTATRAW)

The transmit interrupt status (unmasked) register (TXINTSTATRAW) is shown in Figure B–83 and described in Table B–89.

Figure B–83. Transmit Interrupt Status (Unmasked) Register (TXINTSTATRAW)

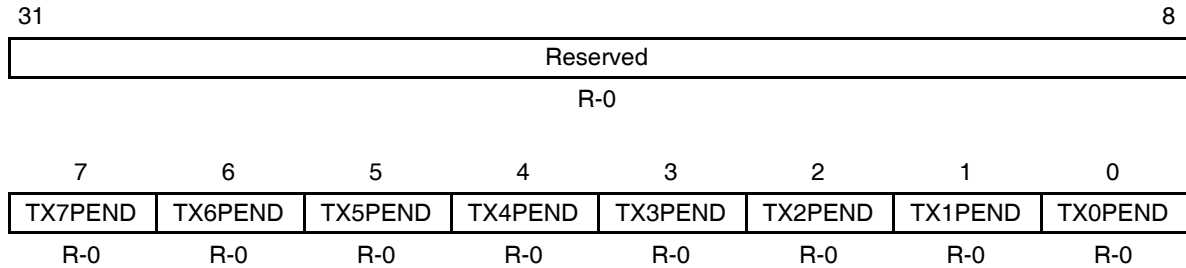

Legend: R = Read only; -n = value after reset

Table B–89. Transmit Interrupt Status (Unmasked) Register (TXINTSTATRAW)
Field Values

Bit	field [†]	symval [†]	Value	Description
31–8	Reserved	–	0	Reserved. The reserved bit location is always read as 0. A value written to this field has no effect.
7	TX7PEND			TX7PEND raw interrupt read (before mask)
6	TX6PEND			TX6PEND raw interrupt read (before mask)
5	TX5PEND			TX5PEND raw interrupt read (before mask)
4	TX4PEND			TX4PEND raw interrupt read (before mask)
3	TX3PEND			TX3PEND raw interrupt read (before mask)
2	TX2PEND			TX2PEND raw interrupt read (before mask)
1	TX1PEND			TX1PEND raw interrupt read (before mask)
0	TX0PEND			TX0PEND raw interrupt read (before mask)

[†] For CSL implementation, use the notation EMAC_TXINTSTATRAW_field_symval

B.5.18 Transmit Interrupt Status (Masked) Register (TXINTSTATMASKED)

The transmit interrupt status (masked) register (TXINTSTATMASKED) is shown in Figure B–84 and described in Table B–90.

Figure B–84. Transmit Interrupt Status (Masked) Register (TXINTSTATMASKED)

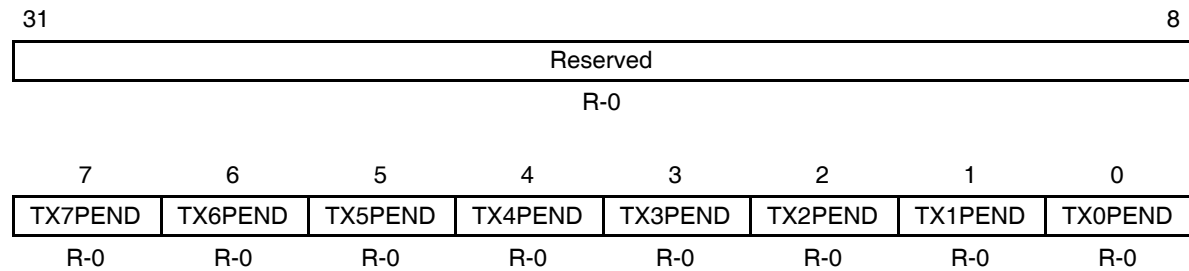

Legend: R = Read only; -n = value after reset

Table B–90. Transmit Interrupt Status (Masked) Register (TXINTSTATMASKED)
Field Values

Bit	field [†]	symval [†]	Value	Description
31–8	Reserved	–	0	Reserved. The reserved bit location is always read as 0. A value written to this field has no effect.
7	TX7PEND			TX7PEND masked interrupt read
6	TX6PEND			TX6PEND masked interrupt read
5	TX5PEND			TX5PEND masked interrupt read
4	TX4PEND			TX4PEND masked interrupt read
3	TX3PEND			TX3PEND masked interrupt read
2	TX2PEND			TX2PEND masked interrupt read
1	TX1PEND			TX1PEND masked interrupt read
0	TX0PEND			TX0PEND masked interrupt read

[†] For CSL implementation, use the notation EMAC_TXINTSTATMASKED_field_symval

B.5.19 Transmit Interrupt Mask Set Register (TXINTMASKSET)

The transmit interrupt mask set register (TXINTMASKSET) is shown in Figure B–85 and described in Table B–91.

Figure B–85. Transmit Interrupt Mask Set Register (TXINTMASKSET)

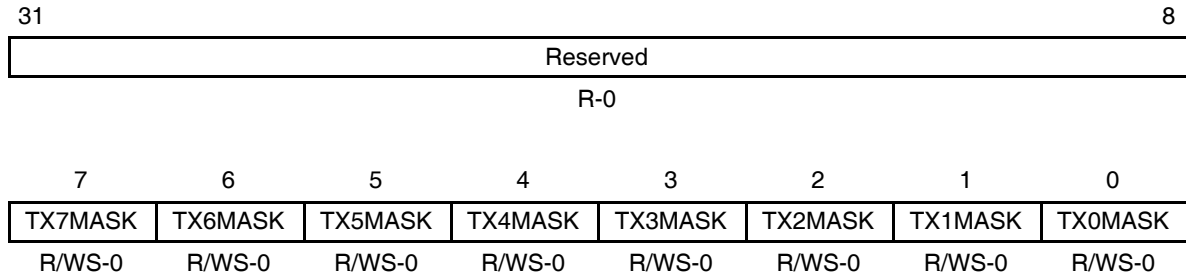

Legend: R = Read only; WS = Write 1 to set, write of 0 has no effect; -n = value after reset

Table B–91. Transmit Interrupt Mask Set Register (TXINTMASKSET)
Field Values

Bit	field [†]	symval [†]	Value	Description
31–8	Reserved	–	0	Reserved. The reserved bit location is always read as 0. A value written to this field has no effect.
7	TX7MASK		0	No effect.
			1	Transmit channel 7 interrupt is enabled.
6	TX6MASK		0	No effect.
			1	Transmit channel 6 interrupt is enabled.
5	TX5MASK		0	No effect.
			1	Transmit channel 5 interrupt is enabled.

[†] For CSL implementation, use the notation EMAC_TXINTMASKSET_field_symval

**Table B–91. Transmit Interrupt Mask Set Register (TXINTMASKSET)
Field Values (Continued)**

Bit	field [†]	symval [†]	Value	Description
4	TX4MASK			Transmit channel 4 interrupt mask set bit. Write 1 to enable interrupt, a write of 0 has no effect.
			0	No effect.
			1	Transmit channel 4 interrupt is enabled.
3	TX3MASK			Transmit channel 3 interrupt mask set bit. Write 1 to enable interrupt, a write of 0 has no effect.
			0	No effect.
			1	Transmit channel 3 interrupt is enabled.
2	TX2MASK			Transmit channel 2 interrupt mask set bit. Write 1 to enable interrupt, a write of 0 has no effect.
			0	No effect.
			1	Transmit channel 2 interrupt is enabled.
1	TX1MASK			Transmit channel 1 interrupt mask set bit. Write 1 to enable interrupt, a write of 0 has no effect.
			0	No effect.
			1	Transmit channel 1 interrupt is enabled.
0	TX0MASK			Transmit channel 0 interrupt mask set bit. Write 1 to enable interrupt, a write of 0 has no effect.
			0	No effect.
			1	Transmit channel 0 interrupt is enabled.

[†] For CSL implementation, use the notation EMAC_TXINTMASKSET_field_symval

B.5.20 Transmit Interrupt Mask Clear Register (TXINTMASKCLEAR)

The transmit interrupt mask clear register (TXINTMASKCLEAR) is shown in Figure B–86 and described in Table B–92.

Figure B–86. Transmit Interrupt Mask Clear Register (TXINTMASKCLEAR)

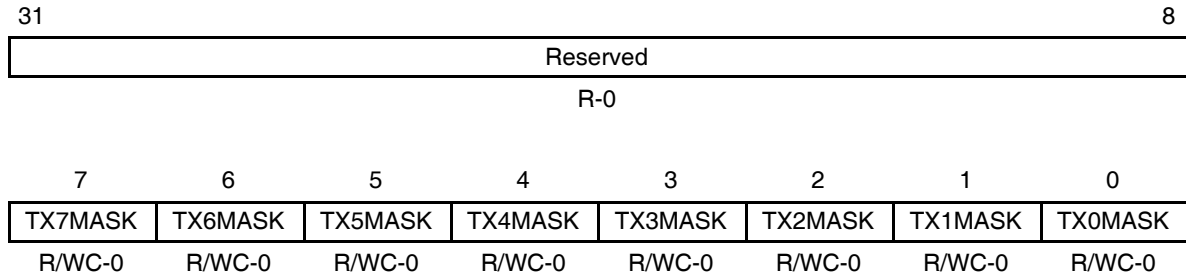

Legend: R = Read only; WC = Write 1 to clear, write of 0 has no effect; -n = value after reset

Table B–92. Transmit Interrupt Mask Clear Register (TXINTMASKCLEAR)
Field Values

Bit	field [†]	symval [†]	Value	Description
31–8	Reserved	–	0	Reserved. The reserved bit location is always read as 0. A value written to this field has no effect.
7	TX7MASK		0	No effect.
			1	Transmit channel 7 interrupt is disabled.
6	TX6MASK		0	No effect.
			1	Transmit channel 6 interrupt is disabled.
5	TX5MASK		0	No effect.
			1	Transmit channel 5 interrupt is disabled.

[†] For CSL implementation, use the notation EMAC_TXINTMASKCLEAR_field_symval

**Table B–92. Transmit Interrupt Mask Clear Register (TXINTMASKCLEAR)
Field Values (Continued)**

Bit	field [†]	symval [†]	Value	Description
4	TX4MASK			Transmit channel 4 interrupt mask clear bit. Write 1 to disable interrupt, a write of 0 has no effect.
			0	No effect.
			1	Transmit channel 4 interrupt is disabled.
3	TX3MASK			Transmit channel 3 interrupt mask clear bit. Write 1 to disable interrupt, a write of 0 has no effect.
			0	No effect.
			1	Transmit channel 3 interrupt is disabled.
2	TX2MASK			Transmit channel 2 interrupt mask clear bit. Write 1 to disable interrupt, a write of 0 has no effect.
			0	No effect.
			1	Transmit channel 2 interrupt is disabled.
1	TX1MASK			Transmit channel 1 interrupt mask clear bit. Write 1 to disable interrupt, a write of 0 has no effect.
			0	No effect.
			1	Transmit channel 1 interrupt is disabled.
0	TX0MASK			Transmit channel 0 interrupt mask clear bit. Write 1 to disable interrupt, a write of 0 has no effect.
			0	No effect.
			1	Transmit channel 0 interrupt is disabled.

[†] For CSL implementation, use the notation EMAC_TXINTMASKCLEAR_ *field_symval*

B.5.21 MAC Input Vector Register (MACINVECTOR)

The MAC input vector register (MACINVECTOR) is shown in Figure B–87 and described in Table B–93. MACINVECTOR contains the current interrupt status of all individual EMAC and MDIO module interrupts. With a single MACINVECTOR read, you can monitor the status of all device interrupts.

Figure B–87. MAC Input Vector Register (MACINVECTOR)

31	30	29	18	17	16	
USERINT	LINKINT	Reserved			HOSTPEND	STATPEND
R-0	R-0	R-0			R-0	R-0
		8 7				
15	RXPEND			TXPEND		0
			R-0			

Legend: R = Read only; -n = value after reset

Table B–93. MAC Input Vector Register (MACINVECTOR) Field Values

Bit	field [†]	symval [†]	Value	Description
31	USERINT			MDIO module user interrupt (USERINT) pending status bit.
30	LINKINT			MDIO module link change interrupt (LINKINT) pending status bit.
29–18	Reserved	–	0	Reserved. The reserved bit location is always read as 0. A value written to this field has no effect.
17	HOSTPEND			EMAC module host error interrupt pending (HOSTPEND) status bit.
16	STATPEND			EMAC module statistics interrupt pending (STATPEND) status bit.
15–8	RXPEND		0–FFh	Receive channel 0–7 interrupt pending (RXPEND) status bit. Bit 8 is receive channel 0.
7–0	TXPEND		0–FFh	Transmit channel 0–7 interrupt pending (TXPEND) status bit. Bit 0 is transmit channel 0.

[†] For CSL implementation, use the notation EMAC_MACINVECTOR_field_symval

B.5.22 Receive Interrupt Status (Unmasked) Register (RXINTSTATRAW)

The receive interrupt status (unmasked) register (RXINTSTATRAW) is shown in Figure B–88 and described in Table B–94.

Figure B–88. Receive Interrupt Status (Unmasked) Register (RXINTSTATRAW)

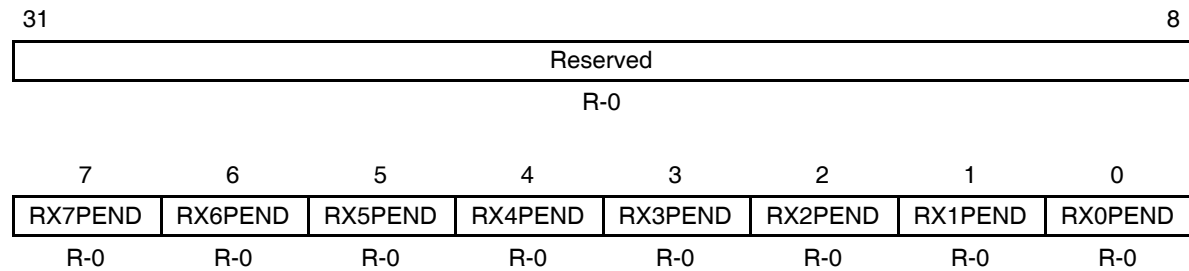

Legend: R = Read only; -n = value after reset

Table B–94. Receive Interrupt Status (Unmasked) Register (RXINTSTATRAW)
Field Values

Bit	field [†]	symval [†]	Value	Description
31–8	Reserved	–	0	Reserved. The reserved bit location is always read as 0. A value written to this field has no effect.
7	RX7PEND			RX7PEND raw interrupt read (before mask)
6	RX6PEND			RX6PEND raw interrupt read (before mask)
5	RX5PEND			RX5PEND raw interrupt read (before mask)
4	RX4PEND			RX4PEND raw interrupt read (before mask)
3	RX3PEND			RX3PEND raw interrupt read (before mask)
2	RX2PEND			RX2PEND raw interrupt read (before mask)
1	RX1PEND			RX1PEND raw interrupt read (before mask)
0	RX0PEND			RX0PEND raw interrupt read (before mask)

[†] For CSL implementation, use the notation EMAC_RXINTSTATRAW_field_symval

B.5.23 Receive Interrupt Status (Masked) Register (RXINTSTATMASKED)

The receive interrupt status (masked) register (RXINTSTATMASKED) is shown in Figure B–89 and described in Table B–95.

Figure B–89. Receive Interrupt Status (Masked) Register (RXINTSTATMASKED)

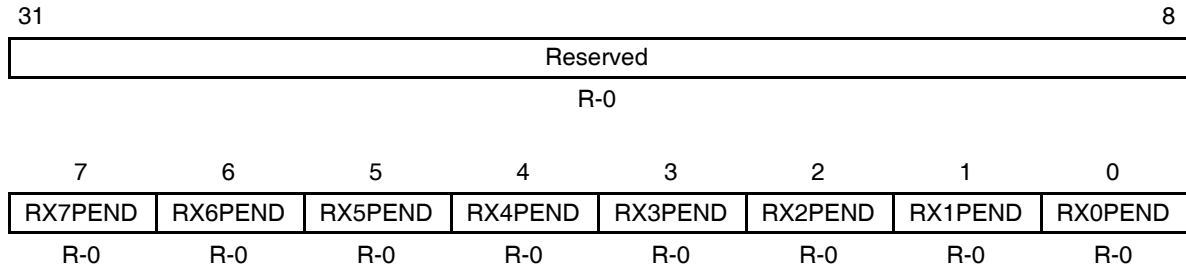

Legend: R = Read only; -n = value after reset

Table B–95. Receive Interrupt Status (Masked) Register (RXINTSTATMASKED)
Field Values

Bit	field [†]	symval [†]	Value	Description
31–8	Reserved	–	0	Reserved. The reserved bit location is always read as 0. A value written to this field has no effect.
7	RX7PEND			RX7PEND masked interrupt read
6	RX6PEND			RX6PEND masked interrupt read
5	RX5PEND			RX5PEND masked interrupt read
4	RX4PEND			RX4PEND masked interrupt read
3	RX3PEND			RX3PEND masked interrupt read
2	RX2PEND			RX2PEND masked interrupt read
1	RX1PEND			RX1PEND masked interrupt read
0	RX0PEND			RX0PEND masked interrupt read

[†] For CSL implementation, use the notation EMAC_RXINTSTATMASKED_field_symval

B.5.24 Receive Interrupt Mask Set Register (RXINTMASKSET)

The receive interrupt mask set register (RXINTMASKSET) is shown in Figure B–90 and described in Table B–96.

Figure B–90. Receive Interrupt Mask Set Register (RXINTMASKSET)

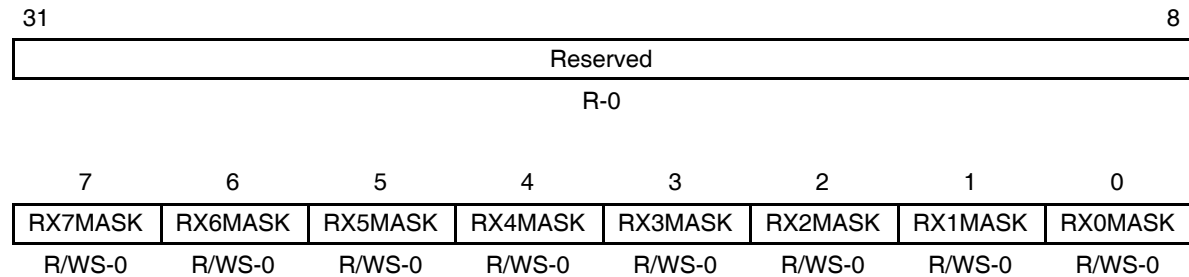

Legend: R = Read only; WS = Write 1 to set, write of 0 has no effect; -n = value after reset

Table B–96. Receive Interrupt Mask Set Register (RXINTMASKSET)
Field Values

Bit	field [†]	symval [†]	Value	Description
31–8	Reserved	–	0	Reserved. The reserved bit location is always read as 0. A value written to this field has no effect.
7	RX7MASK		0	Receive channel 7 interrupt mask set bit. Write 1 to enable interrupt, a write of 0 has no effect.
			0	No effect.
			1	Receive channel 7 interrupt is enabled.
6	RX6MASK		0	Receive channel 6 interrupt mask set bit. Write 1 to enable interrupt, a write of 0 has no effect.
			0	No effect.
			1	Receive channel 6 interrupt is enabled.
5	RX5MASK		0	Receive channel 5 interrupt mask set bit. Write 1 to enable interrupt, a write of 0 has no effect.
			0	No effect.
			1	Receive channel 5 interrupt is enabled.

[†] For CSL implementation, use the notation EMAC_RXINTMASKSET_field_symval

**Table B–96. Receive Interrupt Mask Set Register (RXINTMASKSET)
Field Values (Continued)**

Bit	field [†]	symval [†]	Value	Description
4	RX4MASK			Receive channel 4 interrupt mask set bit. Write 1 to enable interrupt, a write of 0 has no effect.
			0	No effect.
			1	Receive channel 4 interrupt is enabled.
3	RX3MASK			Receive channel 3 interrupt mask set bit. Write 1 to enable interrupt, a write of 0 has no effect.
			0	No effect.
			1	Receive channel 3 interrupt is enabled.
2	RX2MASK			Receive channel 2 interrupt mask set bit. Write 1 to enable interrupt, a write of 0 has no effect.
			0	No effect.
			1	Receive channel 2 interrupt is enabled.
1	RX1MASK			Receive channel 1 interrupt mask set bit. Write 1 to enable interrupt, a write of 0 has no effect.
			0	No effect.
			1	Receive channel 1 interrupt is enabled.
0	RX0MASK			Receive channel 0 interrupt mask set bit. Write 1 to enable interrupt, a write of 0 has no effect.
			0	No effect.
			1	Receive channel 0 interrupt is enabled.

[†] For CSL implementation, use the notation EMAC_RXINTMASKSET_ *field_symval*

B.5.25 Receive Interrupt Mask Clear Register (RXINTMASKCLEAR)

The receive interrupt mask clear register (RXINTMASKCLEAR) is shown in Figure B–91 and described in Table B–97.

Figure B–91. Receive Interrupt Mask Clear Register (RXINTMASKCLEAR)

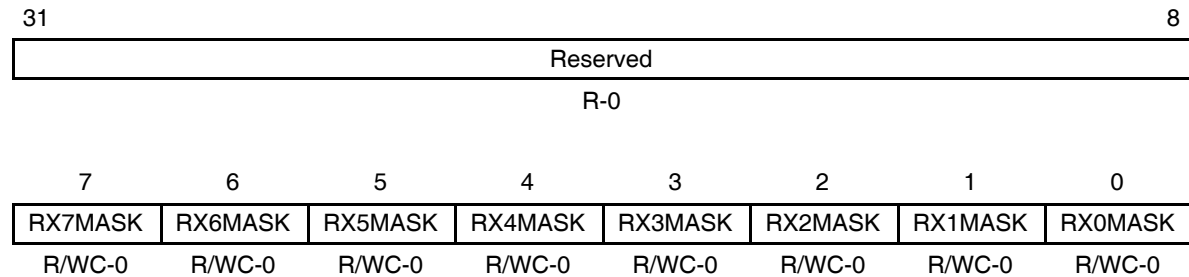

Legend: R = Read only; WC = Write 1 to clear, write of 0 has no effect; -n = value after reset

Table B–97. Receive Interrupt Mask Clear Register (RXINTMASKCLEAR)
Field Values

Bit	field [†]	symval [†]	Value	Description
31–8	Reserved	–	0	Reserved. The reserved bit location is always read as 0. A value written to this field has no effect.
7	RX7MASK		0	No effect.
			1	Receive channel 7 interrupt is disabled.
6	RX6MASK		0	No effect.
			1	Receive channel 6 interrupt is disabled.
5	RX5MASK		0	No effect.
			1	Receive channel 5 interrupt is disabled.

[†] For CSL implementation, use the notation EMAC_RXINTMASKCLEAR_field_symval

**Table B–97. Receive Interrupt Mask Clear Register (RXINTMASKCLEAR)
Field Values (Continued)**

Bit	field [†]	symval [†]	Value	Description
4	RX4MASK			Receive channel 4 interrupt mask clear bit. Write 1 to disable interrupt, a write of 0 has no effect.
			0	No effect.
			1	Receive channel 4 interrupt is disabled.
3	RX3MASK			Receive channel 3 interrupt mask clear bit. Write 1 to disable interrupt, a write of 0 has no effect.
			0	No effect.
			1	Receive channel 3 interrupt is disabled.
2	RX2MASK			Receive channel 2 interrupt mask clear bit. Write 1 to disable interrupt, a write of 0 has no effect.
			0	No effect.
			1	Receive channel 2 interrupt is disabled.
1	RX1MASK			Receive channel 1 interrupt mask clear bit. Write 1 to disable interrupt, a write of 0 has no effect.
			0	No effect.
			1	Receive channel 1 interrupt is disabled.
0	RX0MASK			Receive channel 0 interrupt mask clear bit. Write 1 to disable interrupt, a write of 0 has no effect.
			0	No effect.
			1	Receive channel 0 interrupt is disabled.

[†] For CSL implementation, use the notation EMAC_RXINTMASKCLEAR_field_symval

B.5.26 MAC Interrupt Status (Unmasked) Register (MACINTSTATRAW)

The MAC interrupt status (unmasked) register (MACINTSTATRAW) is shown in Figure B–92 and described in Table B–98.

Figure B–92. MAC Interrupt Status (Unmasked) Register (MACINTSTATRAW)

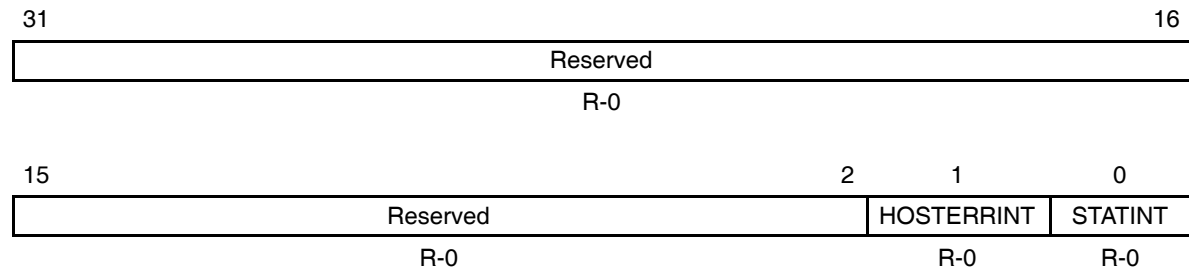

Legend: R = Read only; -n = value after reset

Table B–98. MAC Interrupt Status (Unmasked) Register (MACINTSTATRAW)
Field Values

Bit	field [†]	symval [†]	Value	Description
31–2	Reserved	–	0	Reserved. The reserved bit location is always read as 0. A value written to this field has no effect.
1	HOSTERRINT			Host error interrupt bit. Raw interrupt read (before mask).
0	STATINT			Statistics interrupt bit. Raw interrupt read (before mask).

[†] For CSL implementation, use the notation EMAC_MACINTSTATRAW_field_symval

B.5.27 MAC Interrupt Status (Masked) Register (MACINTSTATMASKED)

The MAC interrupt status (masked) register (MACINTSTATMASKED) is shown in Figure B–93 and described in Table B–99.

Figure B–93. MAC Interrupt Status (Masked) Register (MACINTSTATMASKED)

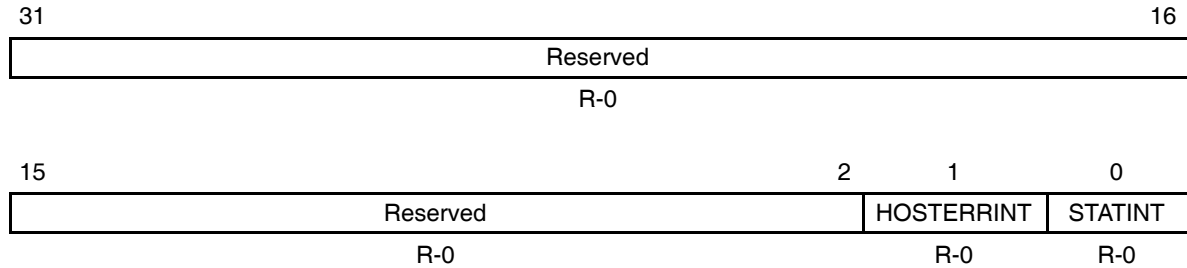

Legend: R = Read only; -n = value after reset

Table B–99. MAC Interrupt Status (Masked) Register (MACINTSTATMASKED)
Field Values

Bit	<i>field</i> [†]	<i>symval</i> [†]	Value	Description
31–2	Reserved	–	0	Reserved. The reserved bit location is always read as 0. A value written to this field has no effect.
1	HOSTERRINT			Host error interrupt bit. Masked interrupt read.
0	STATINT			Statistics interrupt bit. Masked interrupt read.

[†] For CSL implementation, use the notation EMAC_MACINTSTATMASKED_*field_symval*

B.5.28 MAC Interrupt Mask Set Register (MACINTMASKSET)

The MAC interrupt mask set register (MACINTMASKSET) is shown in Figure B–94 and described in Table B–100.

Figure B–94. MAC Interrupt Mask Set Register (MACINTMASKSET)

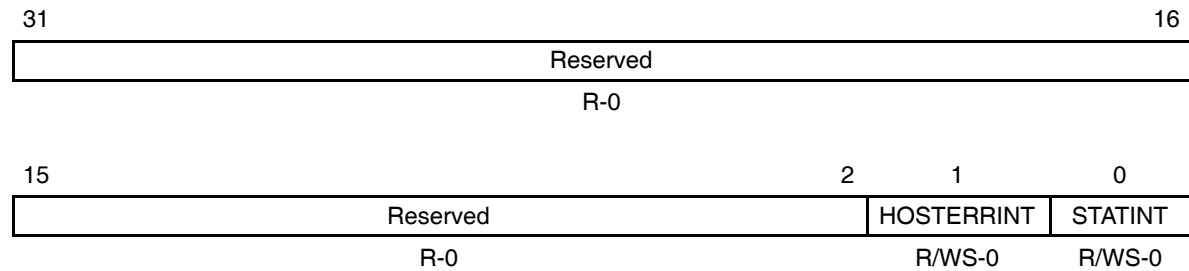

Legend: R = Read only; WS = Write 1 to set, write of 0 has no effect; -n = value after reset

Table B–100. MAC Interrupt Mask Set Register (MACINTMASKSET) Field Values

Bit	field [†]	symval [†]	Value	Description
31–2	Reserved	–	0	Reserved. The reserved bit location is always read as 0. A value written to this field has no effect.
1	HOSTERRINT		0	Host error interrupt mask set bit. Write 1 to enable interrupt, a write of 0 has no effect.
			0	No effect.
			1	Host error interrupt is enabled.
0	STATINT		0	Statistics interrupt mask set bit. Write 1 to enable interrupt, a write of 0 has no effect.
			0	No effect.
			1	Statistics interrupt is enabled.

[†] For CSL implementation, use the notation EMAC_MACINTMASKSET_field_symval

B.5.29 MAC Interrupt Mask Clear Register (MACINTMASKCLEAR)

The MAC interrupt mask clear register (MACINTMASKCLEAR) is shown in Figure B–95 and described in Table B–101.

Figure B–95. MAC Interrupt Mask Clear Register (MACINTMASKCLEAR)

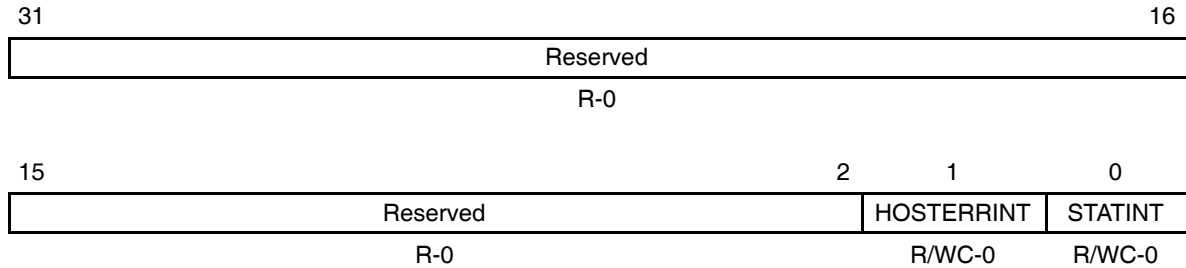

Legend: R = Read only; WC = Write 1 to clear, write of 0 has no effect; -n = value after reset

Table B–101. MAC Interrupt Mask Clear Register (MACINTMASKCLEAR) Field Values

Bit	field [†]	symval [†]	Value	Description
31–2	Reserved	–	0	Reserved. The reserved bit location is always read as 0. A value written to this field has no effect.
1	HOSTERRINT		0	Host error interrupt mask clear bit. Write 1 to disable interrupt, a write of 0 has no effect.
			0	No effect.
			1	Host error interrupt is disabled.
0	STATINT		0	Statistics interrupt mask clear bit. Write 1 to disable interrupt, a write of 0 has no effect.
			0	No effect.
			1	Statistics interrupt is disabled.

[†] For CSL implementation, use the notation EMAC_MACINTMASKCLEAR_field_symval

B.5.30 MAC Address Channel 0–7 Lower Byte Registers (MACADDRLn)

The MAC address channel n lower byte register (MACADDRLn) is shown in Figure B–96 and described in Table B–102.

In order to facilitate changing the MACADDR values while the device is operating, a channel is disabled when MACADDRLn is written and enabled when MACADDRH is written (provided that the unicast, broadcast, or multicast enable is set). MACADDRH should be written last.

Figure B–96. MAC Address Channel n Lower Byte Register (MACADDRLn)

31	Reserved	8 7	0
R-0		MACADDR8 [7–0] R/W-0	

Legend: R = Read only; R/W = Read/Write; $-n$ = value after reset

Table B–102. MAC Address Channel n Lower Byte Register (MACADDRLn) Field Values

Bit	Field	symval [†]	Value	Description
31–8	Reserved	–	0	Reserved. The reserved bit location is always read as 0. A value written to this field has no effect.
7–0	MACADDR8		0–FFh	Sixth byte (bits 0–7) of MAC specific address.

[†] For CSL implementation, use the notation EMAC_MACADDRLn_MACADDR8_symval

B.5.31 MAC Address Middle Byte Register (MACADDRM)

The MAC address middle byte register (MACADDRM) is shown in Figure B–97 and described in Table B–103.

Figure B–97. MAC Address Middle Byte Register (MACADDRM)

31	Reserved	8 7	0
R-0		MACADDR8 [15–8] R/W-0	

Legend: R = Read only; R/W = Read/Write; $-n$ = value after reset

Table B–103. MAC Address Middle Byte Register (MACADDRM) Field Values

Bit	Field	symval [†]	Value	Description
31–8	Reserved	–	0	Reserved. The reserved bit location is always read as 0. A value written to this field has no effect.
7–0	MACADDR8		0–FFh	Fifth byte (bits 8–15) of MAC specific address.

[†] For CSL implementation, use the notation EMAC_MACADDRM_MACADDR8_symval

B.5.32 MAC Address High Bytes Register (MACADDRH)

The MAC address high bytes register (MACADDRH) is shown in Figure B–98 and described in Table B–104.

Figure B–98. MAC Address High Bytes Register (MACADDRH)

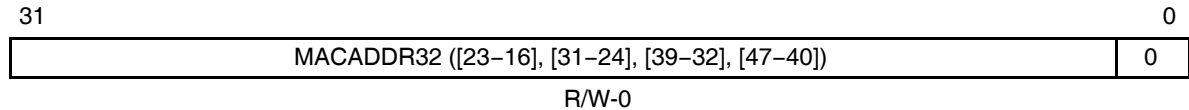

Legend: R/W = Read/Write; -n = value after reset

Table B–104. MAC Address High Bytes Register (MACADDRH) Field Values

Bit	Field	symval [†]	Value	Description
31–0	MACADDR32		0–FFFF FFFEh	First 32 bits (bits 16–47) of MAC specific address. Bit 0 is considered the group/specific bit and is hardwired to 0, writes have no effect. Bit 0 corresponds to the group/specific address bit. Specific addresses always have this bit cleared to 0.

[†] For CSL implementation, use the notation EMAC_MACADDRH_MACADDR32_symval

B.5.33 MAC Address Hash 1 Register (MACHASH1)

The MAC hash registers allow group addressed frames to be accepted on the basis of a hash function of the address. The hash function creates a 6-bit data value (Hash_fun) from the 48-bit destination address (DA) as follows:

```
Hash_fun(0)=DA(0) XOR DA(6) XOR DA(12) XOR DA(18) XOR DA(24) XOR DA(30) XOR DA(36) XOR DA(42);
Hash_fun(1)=DA(1) XOR DA(7) XOR DA(13) XOR DA(19) XOR DA(25) XOR DA(31) XOR DA(37) XOR DA(43);
Hash_fun(2)=DA(2) XOR DA(8) XOR DA(14) XOR DA(20) XOR DA(26) XOR DA(32) XOR DA(38) XOR DA(44);
Hash_fun(3)=DA(3) XOR DA(9) XOR DA(15) XOR DA(21) XOR DA(27) XOR DA(33) XOR DA(39) XOR DA(45);
Hash_fun(4)=DA(4) XOR DA(10) XOR DA(16) XOR DA(22) XOR DA(28) XOR DA(34) XOR DA(40) XOR DA(46);
Hash_fun(5)=DA(5) XOR DA(11) XOR DA(17) XOR DA(23) XOR DA(29) XOR DA(35) XOR DA(41) XOR DA(47);
```

This function is used as an offset into a 64-bit hash table stored in MACHASH1 and MACHASH2 that indicates whether a particular address should be accepted or not.

The MAC address hash 1 register (MACHASH1) is shown in Figure B–99 and described in Table B–105.

Figure B–99. MAC Address Hash 1 Register (MACHASH1)

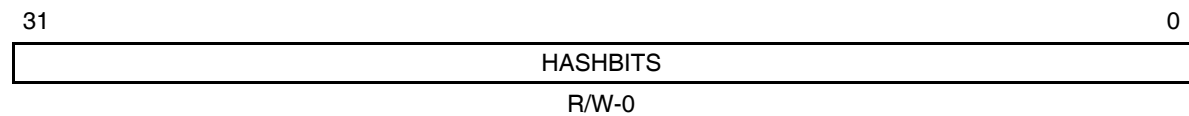

Legend: R/W = Read/Write; -n = value after reset

Table B–105. MAC Address Hash 1 Register (MACHASH1) Field Values

Bit	Field	symval [†]	Value	Description
31–0	HASHBITS		0–FFFF FFFFh	Least-significant 32 bits of the hash table corresponding to hash values 0 to 31. If a hash table bit is set, then a group address that hashes to that bit index is accepted.

[†] For CSL implementation, use the notation EMAC_MACHASH1_HASHBITS_symval

B.5.34 MAC Address Hash 2 Register (MACHASH2)

The MAC address hash 2 register (MACHASH2) is shown in Figure B–100 and described in Table B–106.

Figure B–100. MAC Address Hash 2 Register (MACHASH2)

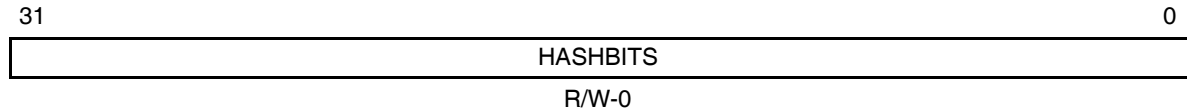

Legend: R/W = Read/Write; -n = value after reset

Table B–106. MAC Address Hash 2 Register (MACHASH2) Field Values

Bit	Field	symval [†]	Value	Description
31–0	HASHBITS		0–FFFF FFFFh	Most-significant 32 bits of the hash table corresponding to hash values 32 to 63. If a hash table bit is set, then a group address that hashes to that bit index is accepted.

[†] For CSL implementation, use the notation EMAC_MACHASH2_HASHBITS_symval

B.5.35 Backoff Test Register (BOFFTEST)

The backoff test register (BOFFTEST) is shown in Figure B–101 and described in Table B–107.

Figure B–101. Backoff Test Register (BOFFTEST)

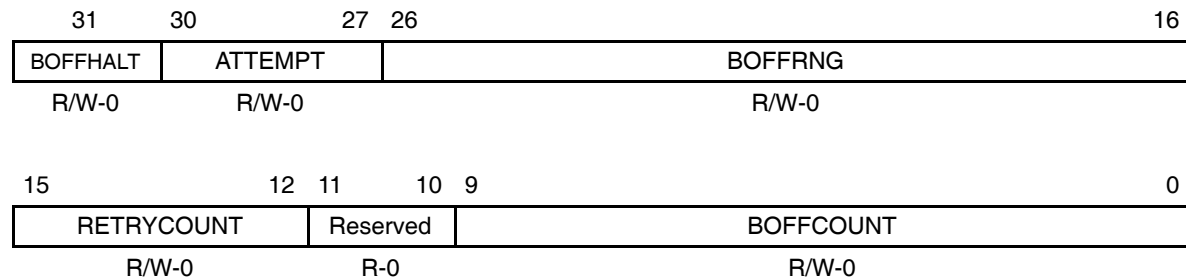

Legend: R = Read only; R/W = Read/Write; -n = value after reset

Table B–107. Backoff Test Register (BOFFTEST) Field Values

Field	field [†]	symval [†]	Value	Function
31	BOFFHALT			
30–27	ATTEMPT		0–Fh	Initial collision attempt count bits is the number of collisions the current frame has experienced.
26–16	BOFFRNG		0–7FFh	Backoff random number generator bits allow the backoff random number generator to be read (or written in test mode only). This field can be written only when the MTEST bit in MACCONTROL has previously been set. Reading this field returns the generator's current value. The value is reset to 0 and begins counting on the clock after the deassertion of reset.
15–12	RETRYCOUNT		0–Fh	
11–10	Reserved	–	0	Reserved. The reserved bit location is always read as 0. A value written to this field has no effect.
9–0	BOFFCOUNT		0–3FFh	Backoff current count bits allow the current value of the backoff counter to be observed for test purposes. This field is loaded automatically according to the backoff algorithm and is decremented by 1 for each slot time after the collision.

[†] For CSL implementation, use the notation EMAC_BOFFTEST_field_symval

B.5.36 Transmit Pacing Test Register (TPACETEST)

The transmit pacing test register (TPACETEST) is shown in Figure B–102 and described in Table B–108.

Figure B–102. Transmit Pacing Test Register (TPACETEST)

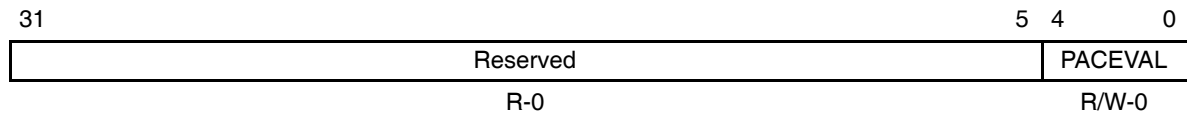

Legend: R = Read only; R/W = Read/Write; -n = value after reset

Table B–108. Transmit Pacing Test Register (TPACETEST) Field Values

Bit	Field	symval [†]	Value	Description
31–5	Reserved	–	0	Reserved. The reserved bit location is always read as 0. A value written to this field has no effect.
4–0	PACEVAL		0–1Fh	Pacing register current value. A nonzero value in this field indicates that transmit pacing is active. A transmit frame collision or deferral causes PACEVAL to be loaded with 1Fh (31), good frame transmissions (with no collisions or deferrals) cause PACEVAL to be decremented down to 0. When PACEVAL is nonzero, the transmitter delays four IPGs between new frame transmissions after each successfully transmitted frame that had no deferrals or collisions. If a transmit frame is deferred or suffers a collision, the IPG time is not stretched to four times the normal value. Transmit pacing helps reduce capture effects, which improves overall network bandwidth.

[†] For CSL implementation, use the notation EMAC_TPACETEST_PACEVAL_symval

B.5.37 Receive Pause Timer Register (RXPAUSE)

The receive pause timer register (RXPAUSE) is shown in Figure B–103 and described in Table B–109.

Figure B–103. Receive Pause Timer Register (RXPAUSE)

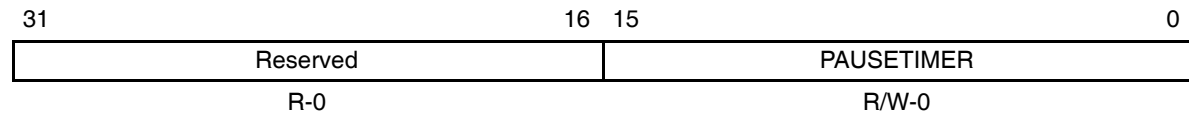

Legend: R = Read only; R/W = Read/Write; -n = value after reset

Table B–109. Receive Pause Timer Register (RXPAUSE) Field Values

Bit	Field	symval [†]	Value	Description
31–16	Reserved	–	0	Reserved. The reserved bit location is always read as 0. A value written to this field has no effect.
15–0	PAUSETIMER		0–FFFFh	Pause timer value bits. This field allows the contents of the receive pause timer to be observed (and written in test mode). The receive pause timer is loaded with FF00h when the EMAC sends an outgoing pause frame (with pause time of FFFFh). The receive pause timer is decremented at slot time intervals. If the receive pause timer decrements to 0, then another outgoing pause frame is sent and the load/decrement process is repeated.

[†] For CSL implementation, use the notation EMAC_RXPAUSE_PAUSETIMER_symval

B.5.38 Transmit Pause Timer Register (TXPAUSE)

The transmit pause timer register (TXPAUSE) is shown in Figure B–104 and described in Table B–110.

Figure B–104. Transmit Pause Timer Register (TXPAUSE)

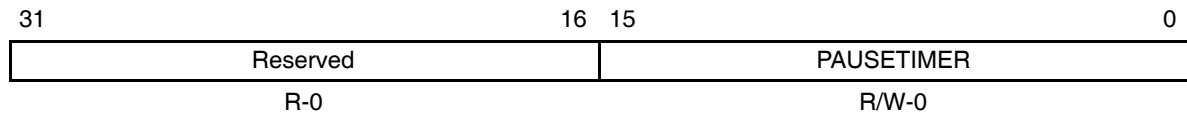

Legend: R = Read only; R/W = Read/Write; -n = value after reset

Table B–110. Transmit Pause Timer Register (TXPAUSE) Field Values

Bit	Field	symval [†]	Value	Description
31–16	Reserved	–	0	Reserved. The reserved bit location is always read as 0. A value written to this field has no effect.
15–0	PAUSETIMER		0–FFFFh	Pause timer value bits – This field allows the contents of the transmit pause timer to be observed (and written in test mode). The transmit pause timer is loaded by a received (incoming) pause frame, and then decremented at slot time intervals down to 0 at which time EMAC transmit frames are again enabled.

[†] For CSL implementation, use the notation EMAC_TXPAUSE_PAUSETIMER_symval

B.5.39 Transmit Channel 0–7 DMA Head Descriptor Pointer Registers (TXnHDP)

The transmit channel n DMA head descriptor pointer register (TXnHDP) is shown in Figure B–105 and described in Table B–111.

Figure B–105. Transmit Channel n DMA Head Descriptor Pointer Register (TXnHDP)

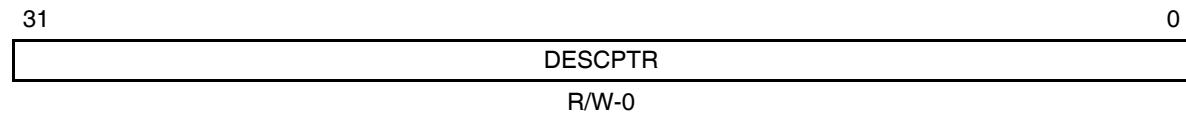

Legend: R/W = Read/Write; $-n$ = value after reset

Table B–111. Transmit Channel n DMA Head Descriptor Pointer Register (TXnHDP)
Field Values

Bit	Field	symval [†]	Value	Description
31–0	DESCPTR		0–FFFF FFFFh	Descriptor pointer bits. Writing a transmit DMA buffer descriptor address to a head pointer location initiates transmit DMA operations in the queue for the selected channel. Writing to these locations when they are nonzero is an error (except at reset). Host software must initialize these locations to zero on reset.

[†] For CSL implementation, use the notation EMAC_TXnHDP_DESCPTR_symval

B.5.40 Receive Channel 0–7 DMA Head Descriptor Pointer Registers (RXnHDP)

The receive channel n DMA head descriptor pointer register (RXnHDP) is shown in Figure B–106 and described in Table B–112.

Figure B–106. Receive Channel n DMA Head Descriptor Pointer Register (RXnHDP)

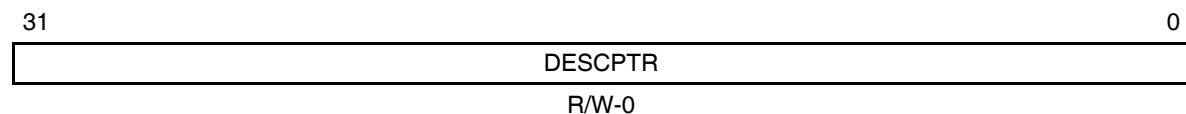

Legend: R/W = Read/Write; $-n$ = value after reset

Table B–112. Receive Channel n DMA Head Descriptor Pointer Register (RXnHDP)
Field Values

Bit	Field	symval [†]	Value	Description
31–0	DESCPTR		0–FFFF FFFFh	Descriptor pointer bits. Writing a receive DMA buffer descriptor address to this location allows receive DMA operations in the selected channel when a channel frame is received. Writing to these locations when they are nonzero is an error (except at reset). Host software must initialize these locations to zero on reset.

[†] For CSL implementation, use the notation EMAC_RXnHDP_DESCPTR_symval

B.5.41 Transmit Channel 0–7 Interrupt Acknowledge Registers (TX n INTACK)

The transmit channel n interrupt acknowledge register (TX n INTACK) is shown in Figure B–107 and described in Table B–113.

Figure B–107. Transmit Channel n Interrupt Acknowledge Register (TX n INTACK)



Legend: R/W = Read/Write; - n = value after reset

Table B–113. Transmit Channel n Interrupt Acknowledge Register (TX n INTACK)
Field Values

Bit	Field	symval [†]	Value	Description
31–0	DESCPTR		0–FFFF FFFFh	Transmit host interrupt acknowledge register bits. This register is written by the host with the buffer descriptor address for the last buffer processed by the host during interrupt processing. The EMAC uses the value written to determine if the interrupt should be deasserted.

[†] For CSL implementation, use the notation EMAC_TX n INTACK_DESCPTR_symval

B.5.42 Receive Channel 0–7 Interrupt Acknowledge Registers (RXnINTACK)

The receive channel n interrupt acknowledge registers (RXnINTACK) is shown in Figure B–108 and described in Table B–114.

The value read is the interrupt acknowledge value that was written by the EMAC DMA controller. The value written to RXnINTACK by the host is compared with the value that the EMAC wrote to determine if the interrupt should remain asserted. The value written is not actually stored in this location. The interrupt is deasserted, if the two values are equal.

Figure B–108. Receive Channel n Interrupt Acknowledge Register (RXnINTACK)

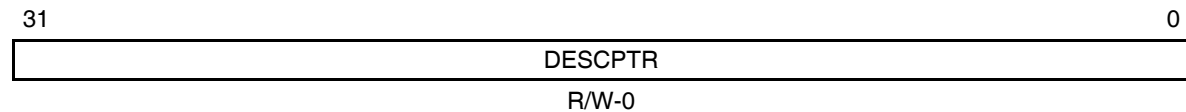

Legend: R/W = Read/Write; - n = value after reset

Table B–114. Receive Channel n Interrupt Acknowledge Register (RXnINTACK)
Field Values

Bit	Field	symval [†]	Value	Description
31–0	DESCPTR		0–FFFF FFFFh	Receive host interrupt acknowledge register bits. This register is written by the host with the buffer descriptor address for the last buffer processed by the host during interrupt processing. The EMAC uses the value written to determine if the interrupt should be deasserted.

[†] For CSL implementation, use the notation EMAC_RXnINTACK_DESCPTR_symval

B.5.43 Network Statistics Registers

The EMAC has a set of statistics that record events associated with frame traffic. The statistics values are cleared to zero, 38 clocks after the rising edge of reset. When the MIEN bit in the MACCONTROL register is set, all statistics registers are write-to-decrement. The value written is subtracted from the register value with the result stored in the register. If a value greater than the statistics value is written, then zero is written to the register (writing FFFF FFFFh clears a statistics location). When the MIEN bit is cleared, all statistics registers are read/write (normal write direct, so writing 0000 0000h clears a statistics location). All write accesses must be 32-bit accesses.

The statistics interrupt (STATPEND) is issued, if enabled, when any statistics value is greater than or equal to 8000 0000h. The statistics interrupt is removed by writing to decrement any statistics value greater than 8000 0000h. The statistics are mapped into internal memory space and are 32-bits wide. All statistics rollover from FFFF FFFFh to 0000 0000h.

The statistics registers are 32-bit registers as shown in Figure B–109.

For CSL implementation, use: `EMAC_register name_COUNT_symval`

Figure B–109. Statistics Register

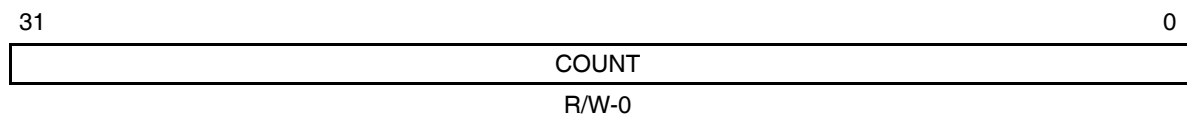

Legend: R/W = Read/Write; -n = value after reset

B.6 External Memory Interface (EMIF) Registers

Table B–115. EMIF Registers

Acronym	Register Name	Section
GBLCTL	EMIF global control register (C620x/C670x)	B.6.1
GBLCTL	EMIF global control register (C621x/C671x)	B.6.2
GBLCTL	EMIF global control register (C64x)	B.6.3
CECTL	EMIF CE space control registers (C620x/C670x)	B.6.4
CECTL	EMIF CE space control registers (C621x/C671x)	B.6.5
CECTL	EMIF CE space control registers (C64x)	B.6.6
CESEC	EMIF CE space secondary control registers (C64x)	B.6.7
SDCTL	EMIF SDRAM control register (C620x/C670x)	B.6.8
SDCTL	EMIF SDRAM control register (C621x/C671x/C64x)	B.6.9
SDCTL	EMIF SDRAM control register (C64x with EMIFA and EMIFB)	B.6.10
SDTIM	EMIF SDRAM timing register	B.6.11
SDEXT	EMIF SDRAM extension register (C621x/C671x/C64x)	B.6.12
PDTCTL	EMIF peripheral device transfer control register (C64x)	B.6.13

B.6.1 EMIF Global Control Register (GBLCTL) (C620x/C670x)

Figure B–110. EMIF Global Control Register (GBLCTL)

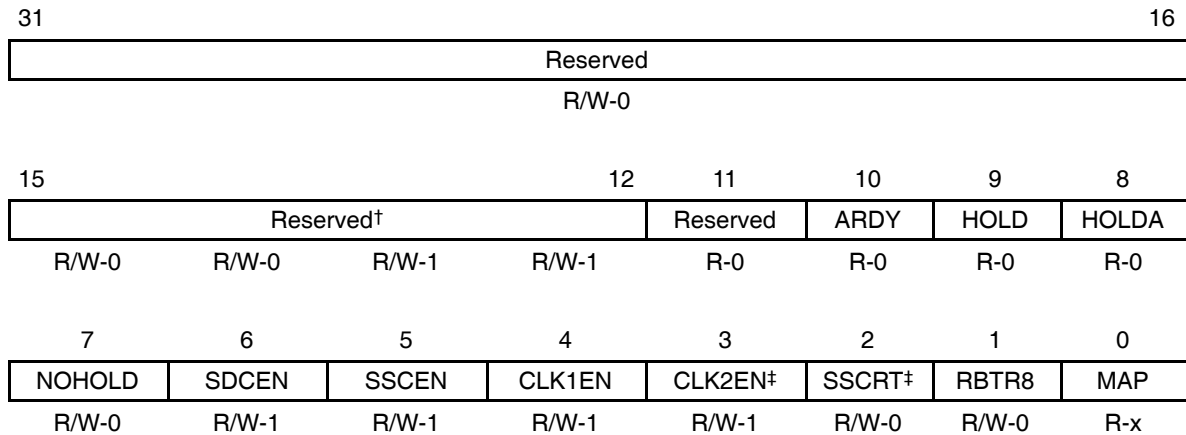

[†] The reserved bit fields should always be written with their default values when modifying the GBLCTL. Writing a value other than the default value to these fields may cause improper operation.

[‡] For C6202/C6203/C6204/C6205 this field is Reserved. The reserved bit fields should always be written with their default values when modifying the GBLCTL. Writing a value other than the default value to these fields may cause improper operation.

Legend: R/W = Read/Write; R = Read only; -n = value after reset; -x = value is indeterminate after reset

Table B–116. EMIF Global Control Register (GBLCTL) Field Values

Bit	field [†]	symval [†]	Value	Description
31–11	Reserved	–	0	Reserved. The reserved bit location is always read as 0. A value written to this field has no effect.
10	ARDY			ARDY input bit.
		LOW	0	ARDY input is low. External device is not ready.
		HIGH	1	ARDY input is high. External device is ready.
9	HOLD			$\overline{\text{HOLD}}$ input bit.
		LOW	0	$\overline{\text{HOLD}}$ input is low. External device requesting EMIF.
		HIGH	1	$\overline{\text{HOLD}}$ input is high. No external request pending.
8	HOLDA			$\overline{\text{HOLDA}}$ output bit.
		LOW	0	$\overline{\text{HOLDA}}$ output is low. External device owns EMIF.
		HIGH	1	$\overline{\text{HOLDA}}$ output is high. External device does not own EMIF.

[†] For CSL implementation, use the notation EMIF_GBLCTL_field_symval.

Table B–116. EMIF Global Control Register (GBLCTL) Field Values (Continued)

Bit	field [†]	symval [†]	Value	Description
7	NOHOLD			External NOHOLD enable bit.
		DISABLE	0	No hold is disabled. Hold requests via the $\overline{\text{HOLD}}$ input are acknowledged via the HOLDA output at the earliest possible time.
		ENABLE	1	No hold is enabled. Hold requests via the $\overline{\text{HOLD}}$ input are ignored.
6	SDCEN			SDCLK enable bit. This bit enables CLKOUT2 if SDRAM is used in system (specified by the MTYPE field in in the CE space control register).
		DISABLE	0	SDCLK is held high.
		ENABLE	1	SDCLK is enabled to clock.
5	SSCEN			SSCLK enable bit. This bit enables CLKOUT2 if SBSRAM is used in the system (specified by the MTYPE field in in the CE space control register).
		DISABLE	0	SSCLK is held high.
		ENABLE	1	SSCLK is enabled to clock.
4	CLK1EN			CLKOUT1 enable bit.
		DISABLE	0	CLKOUT1 is held high.
		ENABLE	1	CLKOUT1 is enabled to clock.
3	CLK2EN			For C6201/C6701 DSP: CLKOUT2 is enabled/disabled using SSCEN/SDCEN bits.
		DISABLE	0	CLKOUT2 is held high.
		ENABLE	1	CLKOUT2 is enabled to clock.
2	SSCRT			For C6201/C6701 DSP: SBSRAM clock rate select bit.
		CPUOVR2	0	SSCLK runs at 1/2 CPU clock rate.
		CPU	1	SSCLK runs at CPU clock rate.
1	RBTR8			Requester arbitration mode bit.
		HPRI	0	The requester controls the EMIF until a high-priority request occurs.
		8ACC	1	The requester controls the EMIF for a minimum of eight accesses.

[†] For CSL implementation, use the notation EMIF_GBLCTL_field_symval.

Table B–116. EMIF Global Control Register (GBLCTL) Field Values (Continued)

Bit	field [†]	symval [†]	Value	Description
0	MAP			Map mode bit contains the value of the memory map mode of the device.
		MAP0	0	Map 0 is selected. External memory located at address 0.
		MAP1	1	Map 1 is selected. Internal memory located at address 0.

[†] For CSL implementation, use the notation EMIF_GBLCTL_*field_symval*.

B.6.2 EMIF Global Control Register (GBLCTL) (C621x/C671x)

Figure B–111. EMIF Global Control Register (GBLCTL)

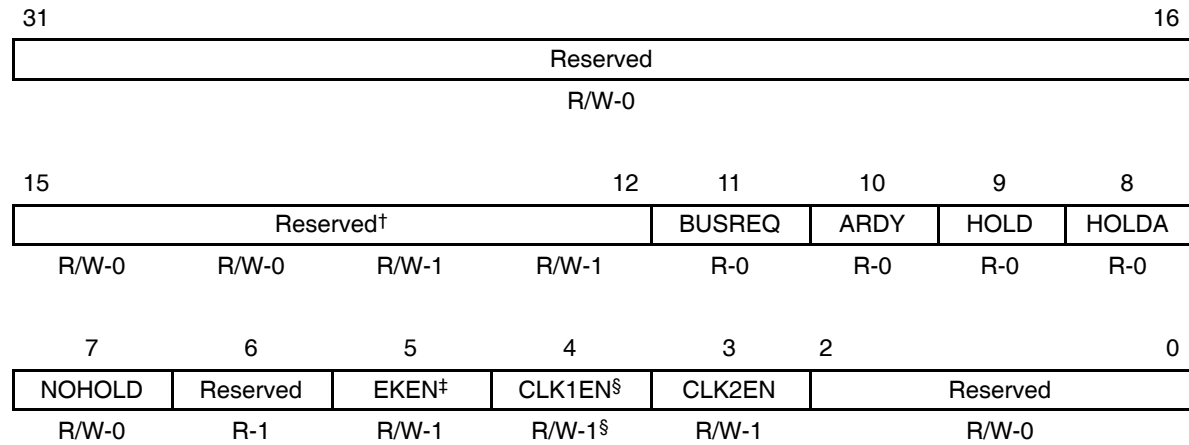

† The reserved bit fields should always be written with their default values when modifying the GBLCTL. Writing a value other than the default value to these fields may cause improper operation.

‡ Available on C6713, C6712C, and C6711C devices only; on other C621x/C671x devices, this field is reserved with R/W-1.

§ This bit is reserved on C6713, C6712C, and C6711C devices with R/W-0. Writing a value other than 0 to this bit may cause improper operation.

Legend: R/W = Read/Write; R = Read only; -n = value after reset

Table B–117. EMIF Global Control Register (GBLCTL) Field Values

Bit	field†	symval†	Value	Description
31–12	Reserved	–	0	Reserved. The reserved bit location is always read as 0. A value written to this field has no effect.
11	BUSREQ			Bus request (BUSREQ) output bit indicates if the EMIF has an access/refresh pending or in progress.
		LOW	0	BUSREQ output is low. No access/refresh pending.
		HIGH	1	BUSREQ output is high. Access/refresh pending or in progress.
10	ARDY			ARDY input bit.
		LOW	0	ARDY input is low. External device is not ready.
		HIGH	1	ARDY input is high. External device is ready.

† For CSL implementation, use the notation EMIF_GBLCTL_field_symval.

‡ ECLKOUT does not turn off/on glitch free via EKEN.

Table B–117. EMIF Global Control Register (GBLCTL) Field Values (Continued)

Bit	field [†]	symval [†]	Value	Description
9	HOLD			$\overline{\text{HOLD}}$ input bit.
		LOW	0	$\overline{\text{HOLD}}$ input is low. External device requesting EMIF.
		HIGH	1	$\overline{\text{HOLD}}$ input is high. No external request pending.
8	HOLDA			$\overline{\text{HOLDA}}$ output bit.
		LOW	0	$\overline{\text{HOLDA}}$ output is low. External device owns EMIF.
		HIGH	1	$\overline{\text{HOLDA}}$ output is high. External device does not own EMIF.
7	NOHOLD			External NOHOLD enable bit.
		DISABLE	0	No hold is disabled. Hold requests via the $\overline{\text{HOLD}}$ input are acknowledged via the HOLDA output at the earliest possible time.
		ENABLE	1	No hold is enabled. Hold requests via the $\overline{\text{HOLD}}$ input are ignored.
6	Reserved	–	1	Reserved. The reserved bit location is always read as 1. A value written to this field has no effect.
5	EKEN [‡]			For C6713, C6712C, and C6711C DSP: ECLKOUT enable bit.
		DISABLE	0	ECLKOUT is held low.
		ENABLE	1	ECLKOUT is enabled to clock (default).
4	CLK1EN			Not on C6713, C6712C, and C6711C DSP: CLKOUT1 enable bit. On C6713, C6712C, and C6711C DSP, this bit must be programmed to 0 for proper operation.
		DISABLE	0	CLKOUT1 is held high.
		ENABLE	1	CLKOUT1 is enabled to clock.
3	CLK2EN			CLKOUT2 is enabled/disabled using SSCEN/SDCEN bits.
		DISABLE	0	CLKOUT2 is held high.
		ENABLE	1	CLKOUT2 is enabled to clock.
2–0	Reserved	–	0	Reserved. The reserved bit location is always read as 0. A value written to this field has no effect.

[†] For CSL implementation, use the notation EMIF_GBLCTL_ *field_symval*.

[‡] ECLKOUT does not turn off/on glitch free via EKEN.

B.6.3 EMIF Global Control Register (GBLCTL) (C64x)

Figure B–112. EMIF Global Control Register (GBLCTL)

31					20	19			18	17	16
Reserved				EK2RATE		EK2HZ		EK2EN			
R/W-0				R/W-10		R/W-0		R/W-1			
15			14	13	12	11	10	9			8
Reserved		BRMODE		Reserved		BUSREQ		ARDY		HOLDA	
R/W-0		R/W-1		R-0		R-0		R-0		R-0	
		7	6	5	4	3	2	1			0
NOHOLD		EK1HZ		EK1EN		CLK4EN		CLK6EN		Reserved	
R/W-0		R/W-1		R/W-1		R/W-1		R/W-1		R/W-0	

Legend: R/W = Read/Write; R = Read only; -n = value after reset

Table B–118. EMIF Global Control Register (GBLCTL) Field Values

Bit	field [†]	symval [†]	Value	Description
31–20	Reserved	–	0	Reserved. The reserved bit location is always read as 0. A value written to this field has no effect.
19–18	EK2RATE [§]		0–3h	ECLKOUT2 rate. ECLKOUT2 runs at:
		FULLCLK	0	1× EMIF input clock (ECLKIN, CPU/4 clock, or CPU/6 clock) rate.
		HALFCLK	1h	1/2× EMIF input clock (ECLKIN, CPU/4 clock, or CPU/6 clock) rate.
		QUARCLK	2h	1/4× EMIF input clock (ECLKIN, CPU/4 clock, or CPU/6 clock) rate.
		–	3h	Reserved.
17	EK2HZ [‡]			ECLKOUT2 high-impedance control bit.
		CLK	0	ECLKOUT2 continues clocking during Hold (if EK2EN = 1).
		HIGHZ	1	ECLKOUT2 is in high-impedance state during Hold.

[†] For CSL implementation, use the notation EMIFA_GBLCTL_field_symval or EMIFB_GBLCTL_field_symval.

[‡] ECLKOUT_n does not turn off/on glitch free via EK_nEN or via EK_nHZ.

[§] ECLKOUT2 rate should only be changed once during EMIF initialization from the default (1/4x) to either 1/2x or 1x.

[¶] Applies to EMIFA only.

Table B–118. EMIF Global Control Register (GBLCTL) Field Values (Continued)

Bit	field [†]	symval [†]	Value	Description
16	EK2EN [‡]			ECLKOUT2 enable bit.
		DISABLE	0	ECLKOUT2 is held low.
		ENABLE	1	ECLKOUT2 is enabled to clock.
15–14	Reserved	–	0	Reserved. The reserved bit location is always read as 0. A value written to this field has no effect.
13	BRMODE			Bus request mode (BRMODE) bit indicates if BUSREQ shows memory refresh status.
		MSTATUS	0	BUSREQ indicates memory access pending or in progress.
		MRSTATUS	1	BUSREQ indicates memory access or refresh pending or in progress.
12	Reserved	–	0	Reserved. The reserved bit location is always read as 0. A value written to this field has no effect.
11	BUSREQ			Bus request (BUSREQ) output bit indicates if the EMIF has an access/refresh pending or in progress.
		LOW	0	BUSREQ output is low. No access/refresh pending.
		HIGH	1	BUSREQ output is high. Access/refresh pending or in progress.
10	ARDY			ARDY input bit. Valid ARDY bit is shown only when performing asynchronous memory access (when async \overline{CE}_n is active).
		LOW	0	ARDY input is low. External device is not ready.
		HIGH	1	ARDY input is high. External device is ready.
9	HOLD			\overline{HOLD} input bit.
		LOW	0	\overline{HOLD} input is low. External device requesting EMIF.
		HIGH	1	\overline{HOLD} input is high. No external request pending.
8	HOLDA			\overline{HOLDA} output bit.
		LOW	0	\overline{HOLDA} output is low. External device owns EMIF.
		HIGH	1	\overline{HOLDA} output is high. External device does not own EMIF.

[†] For CSL implementation, use the notation EMIFA_GBLCTL_field_symval or EMIFB_GBLCTL_field_symval.

[‡] ECLKOUT n does not turn off/on glitch free via EK n EN or via EK n HZ.

[§] ECLKOUT2 rate should only be changed once during EMIF initialization from the default (1/4x) to either 1/2x or 1x.

[¶] Applies to EMIFA only.

Table B–118. EMIF Global Control Register (GBLCTL) Field Values (Continued)

Bit	field [†]	symval [†]	Value	Description
7	NOHOLD			External NOHOLD enable bit.
		DISABLE	0	No hold is disabled. Hold requests via the $\overline{\text{HOLD}}$ input are acknowledged via the HOLDA output at the earliest possible time.
		ENABLE	1	No hold is enabled. Hold requests via the $\overline{\text{HOLD}}$ input are ignored.
6	EK1HZ [‡]			ECLKOUT1 high-impedance control bit.
		CLK	0	ECLKOUT1 continues clocking during Hold (if EK1EN = 1).
		HIGHZ	1	ECLKOUT1 is in high-impedance state during Hold.
5	EK1EN [‡]			ECLKOUT1 enable bit.
		DISABLE	0	ECLKOUT1 is held low.
		ENABLE	1	ECLKOUT1 is enabled to clock.
4	CLK4EN [¶]			CLKOUT4 enable bit. CLKOUT4 pin is muxed with GP1 pin. Upon exiting reset, CLKOUT4 is enabled and clocking. After reset, CLKOUT4 may be configured as GP1 via the GPIO enable register (GPEN).
		DISABLE	0	CLKOUT4 is held high.
		ENABLE	1	CLKOUT4 is enabled to clock.
3	CLK6EN [¶]			CLKOUT 6 enable bit. CLKOUT6 pin is muxed with GP2 pin. Upon exiting reset, CLKOUT6 is enabled and clocking. After reset, CLKOUT6 may be configured as GP2 via the GPIO enable register (GPEN).
		DISABLE	0	CLKOUT6 is held high.
		ENABLE	1	CLKOUT6 is enabled to clock.
2	Reserved	–	1	Reserved. The reserved bit location is always read as 1. A value written to this field has no effect.
1–0	Reserved	–	0	Reserved. The reserved bit location is always read as 0. A value written to this field has no effect.

[†] For CSL implementation, use the notation EMIFA_GBLCTL_ *field_symval* or EMIFB_GBLCTL_ *field_symval*.

[‡] ECLKOUT n does not turn off/on glitch free via EK n EN or via EK n HZ.

[§] ECLKOUT2 rate should only be changed once during EMIF initialization from the default (1/4x) to either 1/2x or 1x.

[¶] Applies to EMIFA only.

B.6.4 EMIF CE Space Control Register (CECTL) (C620x/C670x)*Figure B–113. EMIF CE Space Control Register (CECTL)*

31	28	27	22	21	20	19	16			
WRSETUP		WRSTRB			WRHLD		RDSETUP			
R/W-1111		R/W-11 1111			R/W-11		R/W-1111			
15	14	13	8	7	6	4	3	2	1	0
Reserved		RDSTRB			Rsvd	MTYPE		Reserved		RDHLD
R/W-0		R/W-11 1111			R/W-0	R/W-010		R/W-0		R/W-11

Legend: R/W-x = Read/Write-Reset value

Table B–119. EMIF CE Space Control Register (CECTL) Field Values

Bit	field [†]	symval [†]	Value	Description
31–28	WRSETUP	OF(<i>value</i>)	0–Fh	Write setup width. Number of clock cycles [‡] of setup time for address (EA), chip enable (\overline{CE}), and byte enables ($BE[0-3]$) before write strobe falls. For asynchronous read accesses, this is also the setup time of \overline{AOE} before \overline{ARE} falls.
27–22	WRSTRB	OF(<i>value</i>)	0–3Fh	Write strobe width. The width of write strobe (\overline{AWE}) in clock cycles. [‡]
21–20	WRHLD	OF(<i>value</i>)	0–3h	Write hold width. Number of clock cycles [‡] that address (EA) and byte strobes ($BE[0-3]$) are held after write strobe rises. For asynchronous read accesses, this is also the hold time of \overline{AOE} after \overline{ARE} rising.
19–16	RDSETUP	OF(<i>value</i>)	0–Fh	Read setup width. Number of clock cycles [‡] of setup time for address (EA), chip enable (\overline{CE}), and byte enables ($BE[0-3]$) before read strobe falls. For asynchronous read accesses, this is also the setup time of \overline{AOE} before \overline{ARE} falls.
15–14	Reserved	–	0	Reserved. The reserved bit location is always read as zero. A value written to this field has no effect.
13–8	RDSTRB	OF(<i>value</i>)	0–3Fh	Read strobe width. The width of read strobe (\overline{ARE}) in clock cycles. [‡]
7	Reserved	–	0	Reserved. The reserved bit location is always read as zero. A value written to this field has no effect.

[†] For CSL implementation, use the notation `EMIF_CECTL_field_symval`.

[‡] Clock cycles are in terms of CLKOUT1 for C620x/C670x DSP.

Table B–119. EMIF CE Space Control Register (CECTL) Field Values (Continued)

Bit	field [†]	symval [†]	Value	Description
6–4	MTYPE			Memory type of the corresponding CE spaces.
		ASYNC8	0	8-bit-wide ROM (CE1 only)
		ASYNC16	1h	16-bit-wide ROM (CE1 only)
		ASYNC32	2h	32-bit-wide asynchronous interface
		SDRAM32	3h	32-bit-wide SDRAM (CE0, CE2, CE3 only)
		SBSRAM32	4h	32-bit-wide SBSRAM
	–	5h–7h	Reserved	
3–2	Reserved	–	0	Reserved. The reserved bit location is always read as zero. A value written to this field has no effect.
1–0	RDHLD	OF(value)	0–3h	Read hold width. Number of clock cycles [‡] that address (EA) and byte strobes ($\overline{BE}[0-3]$) are held after read strobe rises. For asynchronous read accesses, this is also the hold time of \overline{AOE} after \overline{ARE} rising.

[†] For CSL implementation, use the notation EMIF_CECTL_field_symval.

[‡] Clock cycles are in terms of CLKOUT1 for C620x/C670x DSP.

B.6.5 EMIF CE Space Control Register (CECTL) (C621x/C671x)*Figure B–114. EMIF CE Space Control Register (CECTL)*

31	28	27	22	21	20	19	16	
WRSETUP		WRSTRB			WRHLD	RDSETUP		
R/W-1111		R/W-11 1111			R/W-11	R/W-1111		
15	14	13	8	7	4	3	2	0
TA		RDSTRB			MTYPE		Reserved	RDHLD
R/W-11		R/W-11 1111			R/W-0010		R-0	R/W-011

Legend: R/W-x = Read/Write-Reset value

Table B–120. EMIF CE Space Control Register (CECTL) Field Values

Bit	field [†]	symval [†]	Value	Description
31–28	WRSETUP	OF(value)	0–Fh	Write setup width. Number of clock cycles [‡] of setup time for address (EA), chip enable (\overline{CE}), and byte enables (\overline{BE}) before write strobe falls. For asynchronous read accesses, this is also the setup time of \overline{AOE} before \overline{ARE} falls.
27–22	WRSTRB	OF(value)	0–3Fh	Write strobe width. The width of write strobe (\overline{AWE}) in clock cycles. [‡]
21–20	WRHLD	OF(value)	0–3h	Write hold width. Number of clock cycles [‡] that address (EA) and byte strobes (\overline{BE}) are held after write strobe rises. For asynchronous read accesses, this is also the hold time of \overline{AOE} after \overline{ARE} rising.
19–16	RDSETUP	OF(value)	0–Fh	Read setup width. Number of clock cycles [‡] of setup time for address (EA), chip enable (\overline{CE}), and byte enables (\overline{BE}) before read strobe falls. For asynchronous read accesses, this is also the setup time of \overline{AOE} before \overline{ARE} falls.
15–14	TA	OF(value)	0–3h	Minimum Turn-Around time. Turn-around time controls the minimum number of ECLKOUT cycles [‡] between a read followed by a write (same or different CE spaces), or between reads from different CE spaces. Applies only to asynchronous memory types.
13–8	RDSTRB	OF(value)	0–3Fh	Read strobe width. The width of read strobe (\overline{ARE}) in clock cycles [‡]

[†] For CSL implementation, use the notation EMIF_CECTL_field_symval.

[‡] Clock cycles are in terms of ECLKOUT for C621x/C671x DSP.

[§] 32-bit interfaces (MTYPE=0010b, 0011b, 0100b) do not apply to C6712 DSP.

Table B–120. EMIF CE Space Control Register (CECTL) Field Values (Continued)

Bit	field [†]	symval [†]	Value	Description
7–4	MTYPE [§]		0–Fh	Memory type of the corresponding CE spaces.
		ASYNC8	0	8-bit-wide asynchronous interface.
		ASYNC16	1h	16-bit-wide asynchronous interface.
		ASYNC32	2h	32-bit-wide asynchronous interface.
		SDRAM32	3h	32-bit-wide SDRAM.
		SBSRAM32	4h	32-bit-wide SBSRAM.
		–	5h–7h	Reserved.
		SDRAM8	8h	8-bit-wide SDRAM.
		SDRAM16	9h	16-bit-wide SDRAM.
		SBSRAM8	Ah	8-bit-wide SBSRAM.
		SYNC8	Ah	If C6712 DSP: 8-bit-wide programmable synchronous memory.
		SBSRAM16	Bh	16-bit-wide SBSRAM.
		SYNC16	Bh	If C6712 DSP: 16-bit-wide programmable synchronous memory.
		–	Ch–Fh	Reserved.
3	Reserved	–	0	Reserved. The reserved bit location is always read as 0. A value written to this field has no effect.
2–0	RDHLD	OF(value)	0–7h	Read hold width. Number of clock cycles [‡] that address (EA) and byte strobes (\overline{BE}) are held after read strobe rises. For asynchronous read accesses, this is also the hold time of \overline{AOE} after \overline{ARE} rising.

[†] For CSL implementation, use the notation EMIF_CECTL_field_symval.

[‡] Clock cycles are in terms of ECLKOUT for C621x/C671x DSP.

[§] 32-bit interfaces (MTYPE=0010b, 0011b, 0100b) do not apply to C6712 DSP.

B.6.6 EMIF CE Space Control Register (CECTL) (C64x)

Figure B–115. EMIF CE Space Control Register (CECTL)

31	28	27	22	21	20	19	16	
WRSETUP		WRSTRB			WRHLD	RDSETUP		
R/W-1111		R/W-11 1111			R/W-11	R/W-1111		
15	14	13	8	7	4	3	2	0
TA		RDSTRB			MTYPE		WRHLDMSB	RDHLD
R/W-11		R/W-11 1111			R/W-0		R/W-0	R/W-011

Legend: R/W-x = Read/Write-Reset value

Table B–121. EMIF CE Space Control Register (CECTL) Field Values

Bit	field [†]	symval [†]	Value	Description
31–28	WRSETUP	OF(value)	0–Fh	Write setup width. Number of clock cycles [‡] of setup time for address (EA), chip enable (\overline{CE}), and byte enables (\overline{BE}) before write strobe falls. For asynchronous read accesses, this is also the setup time of \overline{AOE} before \overline{ARE} falls.
27–22	WRSTRB	OF(value)	0–3Fh	Write strobe width. The width of write strobe (\overline{AWE}) in clock cycles. [‡]
21–20	WRHLD	OF(value)	0–3h	Write hold width. Number of clock cycles [‡] that address (EA) and byte strobes (\overline{BE}) are held after write strobe rises. For asynchronous read accesses, this is also the hold time of \overline{AOE} after \overline{ARE} rising.
19–16	RDSETUP	OF(value)	0–Fh	Read setup width. Number of clock cycles [‡] of setup time for address (EA), chip enable (\overline{CE}), and byte enables (\overline{BE}) before read strobe falls. For asynchronous read accesses, this is also the setup time of \overline{AOE} before \overline{ARE} falls.
15–14	TA	OF(value)	0–3h	Minimum Turn-Around time. Turn-around time controls the minimum number of ECLKOUT cycles [‡] between a read followed by a write (same or different CE spaces), or between reads from different CE spaces. Applies only to asynchronous memory types.
13–8	RDSTRB	OF(value)	0–3Fh	Read strobe width. The width of read strobe (\overline{ARE}) in clock cycles. [‡]

[†] For CSL implementation, use the notation EMIFA_CECTL_field_symval or EMIFB_CECTL_field_symval.

[‡] Clock cycles are in terms of ECLKOUT1 for C64x DSP.

[§] 32-bit and 64-bit interfaces (MTYPE=0010b, 0011b, 0100b, 1100b, 1101b, 1110b) do not apply to C64x EMIFB.

Table B–121. EMIF CE Space Control Register (CECTL) Field Values (Continued)

Bit	field [†]	symval [†]	Value	Description
7–4	MTYPE [§]		0–Fh	Memory type of the corresponding CE spaces.
		ASYN8	0	8-bit-wide asynchronous interface.
		ASYN16	1h	16-bit-wide asynchronous interface.
		ASYN32	2h	32-bit-wide asynchronous interface.
		SDRAM32	3h	32-bit-wide SDRAM.
		SYN32	4h	32-bit-wide programmable synchronous memory.
		–	5h–7h	Reserved.
		SDRAM8	8h	8-bit-wide SDRAM.
		SDRAM16	9h	16-bit-wide SDRAM.
		SYN8	Ah	8-bit-wide programmable synchronous memory.
		SYN16	Bh	16-bit-wide programmable synchronous memory.
		ASYN64	Ch	64-bit-wide asynchronous interface.
		SDRAM64	Dh	64-bit-wide SDRAM.
		SYN64	Eh	64-bit-wide programmable synchronous memory.
		–	Fh	Reserved.
3	WRHLDMSB	OF(<i>value</i>)	0–1	Write hold width MSB is the most-significant bit of write hold.
2–0	RDHLD	OF(<i>value</i>)	0–7h	Read hold width. Number of clock cycles [‡] that address (EA) and byte strobes (BE) are held after read strobe rises. For asynchronous read accesses, this is also the hold time of \overline{AOE} after \overline{ARE} rising.

[†] For CSL implementation, use the notation EMIFA_CECTL_*field_symval* or EMIFB_CECTL_*field_symval*.

[‡] Clock cycles are in terms of ECLKOUT1 for C64x DSP.

[§] 32-bit and 64-bit interfaces (MTYPE=0010b, 0011b, 0100b, 1100b, 1101b, 1110b) do not apply to C64x EMIFB.

B.6.7 EMIF CE Space Secondary Control Register (CESEC) (C64x)

Figure B–116. EMIF CE Space Secondary Control Register (CESEC)

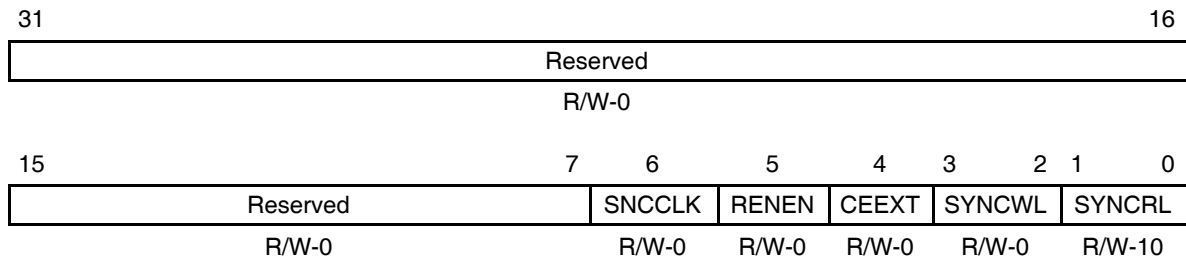

Legend: R/W = Read/Write; -n = value after reset

Table B–122. EMIF CE Space Secondary Control Register (CESEC)
Field Values

Bit	field [†]	symval [†]	Value	Description
31–7	Reserved	–	0	Reserved. The reserved bit location is always read as 0. A value written to this field has no effect.
6	SNCCLK			Synchronization clock selection bit.
		ECLKOUT1	0	Control/data signals for this CE space are synchronized to ECLKOUT1.
		ECLKOUT2	1	Control/data for this CE space are synchronized to ECLKOUT2.
5	RENE			Read Enable enable bit.
		ADS	0	ADS mode. $\overline{\text{SADS}}/\overline{\text{SRE}}$ signal acts as $\overline{\text{SADS}}$ signal. $\overline{\text{SADS}}$ goes active for reads, writes, and deselect. Deselect is issued after a command is completed if no new commands are pending from the EDMA. (used for SBSRAM or ZBT SRAM interface).
		READ	1	Read enable mode. $\overline{\text{SADS}}/\overline{\text{SRE}}$ signal acts as $\overline{\text{SRE}}$ signal. $\overline{\text{SRE}}$ goes low only for reads. No deselect cycle is issued. (used for FIFO interface).
4	CEEXT			CE extension register ENABLE BIT.
		INACTIVE	0	CE goes inactive after the final command has been issued (not necessarily when all the data has been latched).
		ACTIVE	1	On read cycles, the CE signal will go active when $\overline{\text{SOE}}$ goes active and will stay active until $\overline{\text{SOE}}$ goes inactive. The $\overline{\text{SOE}}$ timing is controlled by SYNCRL. (used for synchronous FIFO reads with glue, where $\overline{\text{CE}}$ gates OE).

[†] For CSL implementation, use the notation EMIFA_CESEC_field_symval or EMIFB_CESEC_field_symval.

**Table B–122. EMIF CE Space Secondary Control Register (CESEC)
Field Values (Continued)**

Bit	field [†]	symval [†]	Value	Description
3–2	SYNCWL		0–3h	Synchronous interface data write latency.
		0CYCLE	0	0 cycle read latency.
		1CYCLE	1h	1 cycle read latency.
		2CYCLE	2h	2 cycle read latency.
		3CYCLE	3h	3 cycle read latency.
1–0	SYNCRL		0–3h	Synchronous interface data read latency.
		0CYCLE	0	0 cycle read latency.
		1CYCLE	1h	1 cycle read latency.
		2CYCLE	2h	2 cycle read latency.
		3CYCLE	3h	3 cycle read latency.

[†] For CSL implementation, use the notation EMIFA_CESEC_field_symval or EMIFB_CESEC_field_symval.

B.6.8 EMIF SDRAM Control Register (SDCTL) (C620x/C670x)

Figure B–117. EMIF SDRAM Control Register (SDCTL)

31		27	26	25	24	23		20	19		16	
Reserved			SDWID	RFEN	INIT	TRCD			TRP			
R/W-0			R/W-0	R/W-1	W-1	R/W-1000			R/W-1000			
15		12	11									0
TRC			Reserved									
R/W-1111			R/W-0									

Legend: R/W-x = Read/Write-Reset value

Table B–123. EMIF SDRAM Control Register (SDCTL) Field Values

Bit	field [†]	symval [†]	Value	Description
31–27	Reserved	–	0	Reserved. The reserved bit location is always read as 0. A value written to this field has no effect.
26	SDWID			SDRAM column width select.
		4X8BIT	0	9 column address pins (512 elements per row).
		2X16BIT	1	8 column address pins (256 elements per row).
25	RFEN			Refresh enable bit. If SDRAM is not used, be sure RFEN = 0; otherwise, BUSREQ may become asserted when SDRAM timer counts down to 0.
		DISABLE	0	SDRAM refresh is disabled.
		ENABLE	1	SDRAM refresh is enabled.
24	INIT			Initialization bit. This write-only bit forces initialization of all SDRAM present. Reading this bit returns an undefined value.
		NO	0	No effect.
		YES	1	Initialize SDRAM in each CE space configured for SDRAM. The CPU should initialize all of the CE space control registers before setting INIT = 1.
23–20	TRCD	OF(value)	0–Fh	Specifies the t_{RCD} value of the SDRAM in EMIF clock cycles. [‡] TRCD = $t_{RCD} / t_{cyc} - 1$

[†] For CSL implementation, use the notation EMIF_SDCTL_field_symval.

[‡] t_{cyc} refers to the EMIF clock period, which is equal to CLKOUT2 period for C620x/C670x DSP.

Table B–123. EMIF SDRAM Control Register (SDCTL) Field Values (Continued)

Bit	field [†]	symval [†]	Value	Description
19–16	TRP	OF(value)	0–Fh	Specifies the t_{RC} value of the SDRAM in EMIF clock cycles. [‡] $TRP = t_{RP} / t_{cyc} - 1$
15–12	TRC	OF(value)	0–Fh	Specifies the t_{RC} value of the SDRAM in EMIF clock cycles. [‡] $TRC = t_{RC} / t_{cyc} - 1$
11–0	Reserved	–	0	Reserved. The reserved bit location is always read as 0. A value written to this field has no effect.

[†] For CSL implementation, use the notation EMIF_SDCTL_field_symval.

[‡] t_{cyc} refers to the EMIF clock period, which is equal to CLKOUT2 period for C620x/C670x DSP.

B.6.9 EMIF SDRAM Control Register (SDCTL) (C621x/C671x/C64x)

Figure B–118. EMIF SDRAM Control Register (SDCTL)

31	30	29	28	27	26	25	24	23	20	19	16
Reserved	SDBSZ	SDRSZ	SDCSZ	RFEN	INIT	TRCD			TRP		
R/W-0	R/W-0	R/W-0	R/W-0	R/W-1	W-0	R/W-0100			R/W-1000		
			12	11							0
TRC				Reserved							
R/W-1111				R/W-0							

Legend: R/W-x = Read/Write-Reset value

Table B–124. EMIF SDRAM Control Register (SDCTL) Field Values

Bit	field [†]	symval [†]	Value	Description
31	Reserved	–	0	Reserved. The reserved bit location is always read as 0. A value written to this field has no effect.
30	SDBSZ			SDRAM bank size bit.
		2BANKS	0	One bank-select pin (two banks).
		4BANKS	1	Two bank-select pins (four banks).
29–28	SDRSZ		0–3h	SDRAM row size bits.
		11ROW	0	11 row address pins (2048 rows per bank).
		12ROW	1h	12 row address pins (4096 rows per bank).
		13ROW	2h	13 row address pins (8192 rows per bank).
		–	3h	Reserved.
27–26	SDCSZ		0–3h	SDRAM column size bits.
		9COL	0	9 column address pins (512 elements per row).
		8COL	1h	8 column address pins (256 elements per row).
		10COL	2h	10 column address pins (1024 elements per row).
		–	3h	Reserved.

[†] For CSL implementation, use the notation EMIF_SDCTL_field_symval.

[‡] t_{cyc} refers to the EMIF clock period, which is equal to ECLKOUT period for C621x/C671x DSP; ECLKOUT1 period for the C64x.

Table B–124. EMIF SDRAM Control Register (SDCTL) Field Values (Continued)

Bit	field [†]	symval [†]	Value	Description
25	RFEN			Refresh enable bit. If SDRAM is not used, be sure RFEN = 0; otherwise, BUSREQ may become asserted when SDRAM timer counts down to 0.
		DISABLE	0	SDRAM refresh is disabled.
		ENABLE	1	SDRAM refresh is enabled.
24	INIT			Initialization bit. This write-only bit forces initialization of all SDRAM present. Reading this bit returns an undefined value.
		NO	0	No effect.
		YES	1	Initialize SDRAM in each CE space configured for SDRAM. The CPU should initialize all of the CE space control registers and SDRAM extension register before setting INIT = 1.
23–20	TRCD	OF(value)	0–Fh	Specifies the t_{RCD} value of the SDRAM in EMIF clock cycles. [‡] $TRCD = t_{RCD} / t_{cyc} - 1$
19–16	TRP	OF(value)	0–Fh	Specifies the t_{RP} value of the SDRAM in EMIF clock cycles. [‡] $TRP = t_{RP} / t_{cyc} - 1$
15–12	TRC	OF(value)	0–Fh	Specifies the t_{RC} value of the SDRAM in EMIF clock cycles. [‡] $TRC = t_{RC} / t_{cyc} - 1$
11–0	Reserved	–	0	Reserved. The reserved bit location is always read as 0. A value written to this field has no effect.

[†] For CSL implementation, use the notation EMIF_SDCTL_field_symval.

[‡] t_{cyc} refers to the EMIF clock period, which is equal to ECLKOUT period for C621x/C671x DSP; ECLKOUT1 period for the C64x.

B.6.10 EMIF SDRAM Control Register (SDCTL) (C64x with EMIFA and EMIFB)*Figure B–119. EMIF SDRAM Control Register (SDCTL)*

31	30	29	28	27	26	25	24	23	20	19	16
Reserved	SDBSZ	SDRSZ	SDCSZ	RFEN	INIT	TRCD			TRP		
R/W-0	R/W-0	R/W-0	R/W-0	R/W-1	W-0	R/W-0100			R/W-1000		
15	12		11							1	0
TRC			Reserved						SLFRFR†		
R/W-1111			R/W-0						R/W-0		

Legend: R/W-x = Read/Write-Reset value

† SLFRFR only applies to EMIFA. Bit 0 is Reserved, R/W-0, on EMIFB.

Table B–125. EMIF SDRAM Control Register (SDCTL) Field Values

Bit	field	symval	Value	Description
31	Reserved	–	0	Reserved. The reserved bit location is always read as zero. A value written to this field has no effect.
30	SDBSZ	–	–	SDRAM bank size
		2BANKS	0	One bank-select pin (two banks)
		4BANKS	1	Two bank-select pins (four banks)
29–28	SDRSZ	–	–	SDRAM row size
		11ROW	0	11 row address pins (2048 rows per bank)
		12ROW	1h	12 row address pins (4096 rows per bank)
		13ROW	2h	13 row address pins (8192 rows per bank)
–	–	3h	Reserved	
27–26	SDCSZ	–	–	SDRAM column size
		9COL	0	9 column address pins (512 elements per row)
		8COL	1h	8 column address pins (256 elements per row)
		10COL	2h	10 column address pins (1024 elements per row)
–	–	3h	Reserved	

† For CSL implementation, use the notation EMIFA_SDCTL_field_symval or EMIFB_SDCTL_field_symval.

‡ TRCD specifies the number of ECLKOUT1 cycles between an ACTV command and a READ or WRT command (CAS). The specified separation is maintained while driving write data one cycle earlier.

§ t_{cyc} refers to the EMIF clock period, which is equal to or ECLKOUT1 period for the C64x.

Table B–125. EMIF SDRAM Control Register (SDCTL) Field Values (Continued)

Bit	field	symval	Value	Description
25	RFEN			Refresh enable bit. If SDRAM is not used, be sure RFEN = 0; otherwise, BUSREQ may become asserted when SDRAM timer counts down to 0.
		DISABLE	0	SDRAM refresh is disabled
		ENABLE	1	SDRAM refresh is enabled
24	INIT			Initialization bit. This write-only bit forces initialization of all SDRAM present. Reading this bit returns an undefined value.
		NO	0	No effect
		YES	1	Initialize SDRAM in each CE space configured for SDRAM. EMIF automatically changes INIT back to 0 after SDRAM initialization is performed.
23–20	TRCD [‡]	OF(value)	0–Fh	Specifies the t_{RCD} value of the SDRAM in EMIF clock cycles [§] $\text{TRCD} = t_{\text{RCD}} / t_{\text{cyc}} - 1$
19–16	TRP	OF(value)	0–Fh	Specifies the t_{RP} value of the SDRAM in EMIF clock cycles [§] $\text{TRP} = t_{\text{RP}} / t_{\text{cyc}} - 1$
15–12	TRC	OF(value)	0–Fh	Specifies the t_{RC} value of the SDRAM in EMIF clock cycles [§] $\text{TRC} = t_{\text{RC}} / t_{\text{cyc}} - 1$
11–1	Reserved	–	0	Reserved. The reserved bit location is always read as zero. A value written to this field has no effect.
0	SLFRFR			Self-refresh mode, if SDRAM is used in the system:
			0	Self-refresh mode disabled
			1	Self-refresh mode enabled
				If SDRAM is not used:
			0	General-purpose output SDCKE = 1
	1	General-purpose output SDCKE = 0		

[†] For CSL implementation, use the notation EMIFA_SDCTL_field_symval or EMIFB_SDCTL_field_symval.

[‡] TRCD specifies the number of ECLKOUT1 cycles between an ACTV command and a READ or WRT command (CAS). The specified separation is maintained while driving write data one cycle earlier.

[§] t_{cyc} refers to the EMIF clock period, which is equal to or ECLKOUT1 period for the C64x.

B.6.11 EMIF SDRAM Timing Register (SDTIM)*Figure B–120. EMIF SDRAM Timing Register (SDTIM) (C620x/C670x)*

31	24 23	12 11	0
Reserved	CNTR	PERIOD	
R/W-0	R-040h	R/W-040h	

Legend: R/W-x = Read/Write-Reset value

Figure B–121. EMIF SDRAM Timing Register (SDTIM) (C621x/C671x/C64x)

31	26 25 24 23	12 11	0
Reserved	XRFR	CNTR	PERIOD
R/W-0	R/W-0	R-5DCh	R/W-5DCh

Legend: R/W-x = Read/Write-Reset value

Table B–126. EMIF SDRAM Timing Register (SDTIM) Field Values

Bit	field [†]	symval [†]	Value	Description
31–24	Reserved	–	0	Reserved. The reserved bit location is always read as 0. A value written to this field has no effect.
25–24	XRFR	OF(<i>value</i>)	0–3h	Extra refreshes controls the number of refreshes performed to SDRAM when the refresh counter expires.
			0	1 refresh.
			1h	2 refreshes.
			2h	3 refreshes.
			3h	4 refreshes.
23–12	CNTR	OF(<i>value</i>)	0–FFFh	Current value of the refresh counter.
11–0	PERIOD	OF(<i>value</i>)	0–FFFh	Refresh period in EMIF clock cycles. [‡]

[†] For CSL implementation, use the notation `EMIF_SDTIM_field_symval`, `EMIFA_SDTIM_field_symval`, or `EMIFB_SDTIM_field_symval`.

[‡] For C620x/C670x, EMIF clock cycles = CLKOUT2 cycles.
 For C621x/C671x, EMIF clock cycles = ECLKOUT cycles.
 For C64x, EMIF clock cycles = ECLKOUT1 cycles.

B.6.12 EMIF SDRAM Extension Register (SDEXT) (C621x/C671x/C64x)

Figure B–122. EMIF SDRAM Extension Register (SDEXT)

31				21	20	19	18	17	16	15	14	12
Reserved				WR2RD	WR2DEAC	WR2WR	R2WDQM	RD2WR				
R/W-0				R/W-1	R/W-01	R/W-1	R/W-11	R/W-101				
11	10	9	8	7	6	5	4	3		1	0	
RD2DEAC	RD2RD	THZP		TWR		TRRD	TRAS		TCL			
R/W-11	R/W-1	R/W-10		R/W-01		R/W-1	R/W-111		R/W-1			

Legend: R/W-x = Read/Write-Reset value

Table B–127. EMIF SDRAM Extension Register (SDEXT) Field Values

Bit	field [†]	symval [†]	Value	Description
31–21	Reserved	–	0	Reserved. The reserved bit location is always read as zero. A value written to this field has no effect.
20	WR2RD	OF(value)		Specifies minimum number of cycles between WRITE to READ command of the SDRAM in ECLKOUT cycles [‡] WR2RD = (# of cycles WRITE to READ) – 1
19–18	WR2DEAC	OF(value)	0–3h	Specifies minimum number of cycles between WRITE to DEAC/DCAB command of the SDRAM in ECLKOUT cycles [‡] WR2DEAC = (# of cycles WRITE to DEAC/DCAB) – 1
17	WR2WR	OF(value)		Specifies minimum number of cycles between WRITE to WRITE command of the SDRAM in ECLKOUT cycles [‡] WR2WR = (# of cycles WRITE to WRITE) – 1
16–15	R2WDQM	OF(value)	0–3h	Specifies number of of cycles that BEx signals must be high preceding a WRITE interrupting a READ R2WDQM = (# of cycles BEx high) – 1
14–12	RD2WR	OF(value)	0–7h	Specifies number of cycles between READ to WRITE command of the SDRAM in ECLKOUT cycles [‡] RD2WR = (# of cycles READ to WRITE) – 1
11–10	RD2DEAC	OF(value)	0–3h	Specifies number of cycles between READ to DEAC/DCAB of the SDRAM in ECLKOUT cycles [‡] RD2DEAC = (# of cycles READ to DEAC/DCAB) – 1

[†] For CSL implementation, use the notation EMIF_SDEXT_field_symval, EMIFA_SDEXT_field_symval, or EMIFB_SDEXT_field_symval.

[‡] For C64x, ECLKOUT referenced in this table is equivalent to ECLKOUT1.

[§] t_{cy} refers to the EMIF clock period, which is equal to ECLKOUT period for the C621x/C671x, ECLKOUT1 period for C64x.

Table B–127. EMIF SDRAM Extension Register (SDEXT) Field Values (Continued)

Bit	field [†]	symval [†]	Value	Description
9	RD2RD	OF(value)		Specifies number of cycles between READ to READ command (same CE space) of the SDRAM in ECLKOUT cycles [‡]
			0	READ to READ = 1 ECLKOUT cycle
			1	READ to READ = 2 ECLKOUT cycle
8–7	THZP	OF(value)	0–3h	Specifies t_{HZP} (also known as t_{ROH}) value of the SDRAM in ECLKOUT cycles [‡] $THZP = t_{HZP} / t_{cyc} - 1^{\S}$
6–5	TWR	OF(value)	0–3h	Specifies t_{WR} value of the SDRAM in ECLKOUT cycles [‡] $TWR = t_{WR} / t_{cyc} - 1^{\S}$
4	TRRD	OF(value)		Specifies t_{RRD} value of the SDRAM in ECLKOUT cycles [‡]
			0	$T_{RRD} = 2$ ECLKOUT cycles
			1	$T_{RRD} = 3$ ECLKOUT cycles
3–1	TRAS	OF(value)	0–7h	Specifies t_{RAS} value of the SDRAM in ECLKOUT cycles [‡] $TRAS = t_{RAS} / t_{cyc} - 1^{\S}$
0	TCL	OF(value)		Specified CAS latency of the SDRAM in ECLKOUT cycles [‡]
			0	CAS latency = 2 ECLKOUT cycles
			1	CAS latency = 3 ECLKOUT cycles

[†] For CSL implementation, use the notation `EMIF_SDEXT_field_symval`, `EMIFA_SDEXT_field_symval`, or `EMIFB_SDEXT_field_symval`.

[‡] For C64x, ECLKOUT referenced in this table is equivalent to ECLKOUT1.

[§] t_{cyc} refers to the EMIF clock period, which is equal to ECLKOUT period for the C621x/C671x, ECLKOUT1 period for C64x.

B.6.13 EMIF Peripheral Device Transfer Control Register (PDTCTL) (C64x)

Figure B–123. EMIF Peripheral Device Transfer Control Register (PDTCTL)

31	Reserved	4 3	PDTWL	2 1	PDTRL	0
	R-0		R/W-0		R/W-0	

Legend: R/W = Read/Write; R = Read only; -n = value after reset

Table B–128. EMIF Peripheral Device Transfer Control Register (PDTCTL) Field Values

Bit	field [†]	symval [†]	Value	Description
31–4	Reserved	–	0	Reserved. The reserved bit location is always read as 0. A value written to this field has no effect.
3–2	PDTWL		0–3h	PDT write latency bits.
		0CYCLE	0	$\overline{\text{PDT}}$ signal is asserted 0 cycles prior to the data phase of a write transaction.
		1CYCLE	1h	$\overline{\text{PDT}}$ signal is asserted 1 cycle prior to the data phase of a write transaction.
		2CYCLE	2h	$\overline{\text{PDT}}$ signal is asserted 2 cycles prior to the data phase of a write transaction.
1–0	PDTRL		0–3h	PDT read latency bits.
		0CYCLE	0	$\overline{\text{PDT}}$ signal is asserted 0 cycles prior to the data phase of a read transaction.
		1CYCLE	1h	$\overline{\text{PDT}}$ signal is asserted 1 cycle prior to the data phase of a read transaction.
		2CYCLE	2h	$\overline{\text{PDT}}$ signal is asserted 2 cycles prior to the data phase of a read transaction.
	3CYCLE	3h	$\overline{\text{PDT}}$ signal is asserted 3 cycles prior to the data phase of a read transaction.	

[†] For CSL implementation, use the notation EMIFA_PDTCTL_field_symval.

B.7 General-Purpose Input/Output (GPIO) Registers

Table B–129. GPIO Registers

Acronym	Register Name	Section
GPEN	GPIO enabling register	B.7.1
GPDIR	GPIO direction register	B.7.2
GPVAL	GPIO value register	B.7.3
GPDH	GPIO delta high register	B.7.4
GPHM	GPIO high mask register	B.7.5
GPDL	GPIO delta low register	B.7.6
GPLM	GPIO low mask register	B.7.7
GPGC	GPIO global control register	B.7.8
GPPOL	GPIO interrupt polarity register	B.7.9

B.7.1 GPIO Enable Register (GPEN)

Figure B–124. GPIO Enable Register (GPEN)

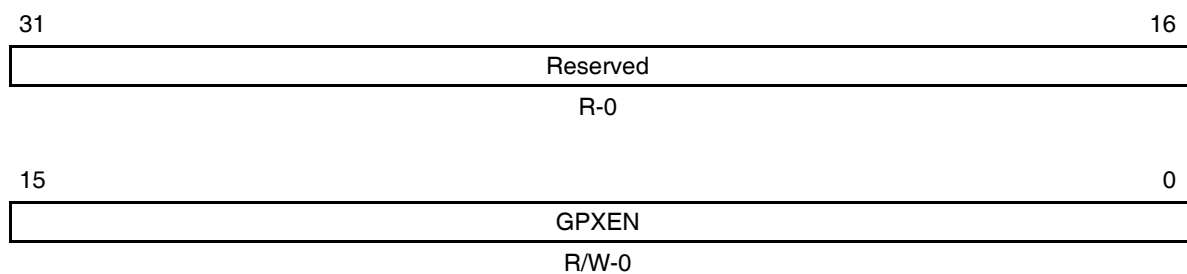

Legend: R/W = Read/Write; -n = value after reset

Table B–130. GPIO Enable Register (GPEN) Field Values

Bit	Field	symval [†]	Value	Description
31–16	Reserved	–	0	Reserved. The reserved bit location is always read as zero. A value written to this field has no effect.
15–0	GPXEN	OF(value)	0	GPIO Mode enable GPx pin is disabled as general-purpose input/output pin. It does not function as a GPIO pin and defaults to high impedance state.
			1	GPx pin is enabled as general-purpose input/output pin. It defaults to high impedance state.

[†] For CSL implementation, use the notation GPIO_GPEN_GPXEN_symval

B.7.2 GPIO Direction Register (GPDIR)

Figure B–125. GPIO Direction Register (GPDIR)

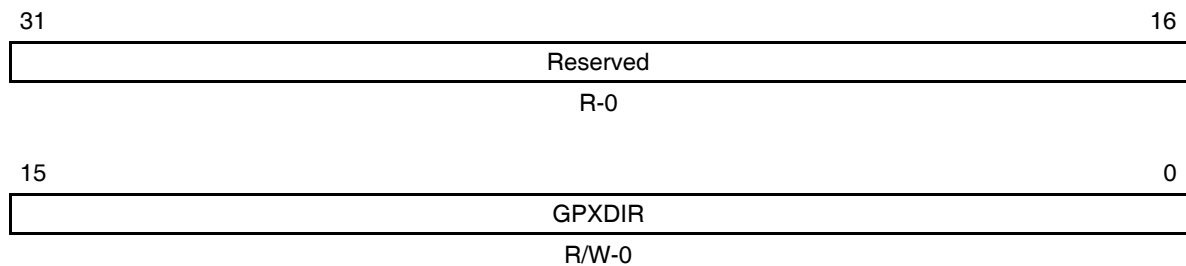

Legend: R/W = Read/Write; -n = value after reset

Table B–131. GPIO Direction Register (GPDIR) Field Values

Bit	Field	symval [†]	Value	Description
31–16	Reserved	–	0	Reserved. The reserved bit location is always read as zero. A value written to this field has no effect.
15–0	GPXDIR	OF(value)	0	GPx Direction. Controls direction (input or output) of GPIO pin. Applies when the corresponding GPxEN bit in the GPEN register is set to 1. GPx pin is an input.
			1	GPx pin is an output.

[†] For CSL implementation, use the notation GPIO_GPDIR_GPXDIR_symval

B.7.3 GPIO Value Register (GPVAL)

Figure B–126. GPIO Value Register (GPVAL)

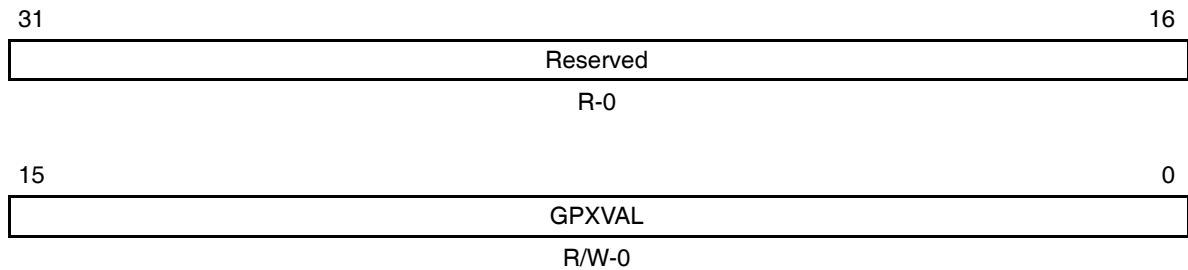

Legend: R/W = Read/Write; -n = value after reset

Table B–132. GPIO Value Register (GPVAL) Field Values

Bit	Field	symval [†]	Value	Description
31–16	Reserved	–	0	Reserved. The reserved bit location is always read as zero. A value written to this field has no effect.
15–0	GPXVAL	OF(<i>value</i>)	0	Value detected at GPx input/output. Applies when the corresponding GPXEN bit in the GPEN register is set to 1. When GPx pin is an input. A value of 0 is latched from the GPx input pin.
			1	A value of 1 is latched from the GPx input pin. When GPx pin is an output. GPx signal is driven low.
			0	GPx signal is driven low.
			1	GPx signal is driven high.

[†] For CSL implementation, use the notation GPIO_GPVAL_GPXVAL_symval

B.7.4 GPIO Delta High Register (GPDH)

Figure B–127. GPIO Delta High Register (GPDH)

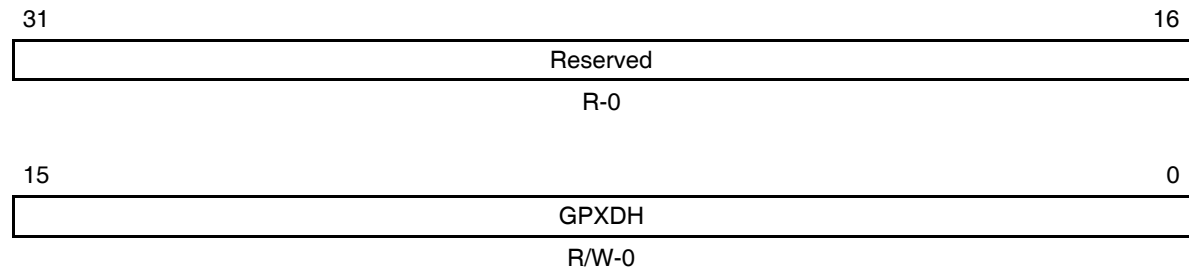

Legend: R/W = Read/Write; -n = value after reset

Table B–133. GPIO Delta High Register (GPDH) Field Values

Bit	Field	symval [†]	Value	Description
31–16	Reserved	–	0	Reserved. The reserved bit location is always read as zero. A value written to this field has no effect.
15–0	GPXDH	OF(value)	0	A low-to-high transition is not detected on GPx
			1	A low-to-high transition is detected on GPx
				GPx Delta High. A low-to-high transition is detected on the GPx input. Applies when the corresponding GPx pin is enabled as an input (GPXEN = 1 and GPXDIR = 0)

[†] For CSL implementation, use the notation GPIO_GPDH_GPXDH_symval

B.7.5 GPIO High Mask Register (GPHM)

Figure B–128. GPIO High Mask Register (GPHM)

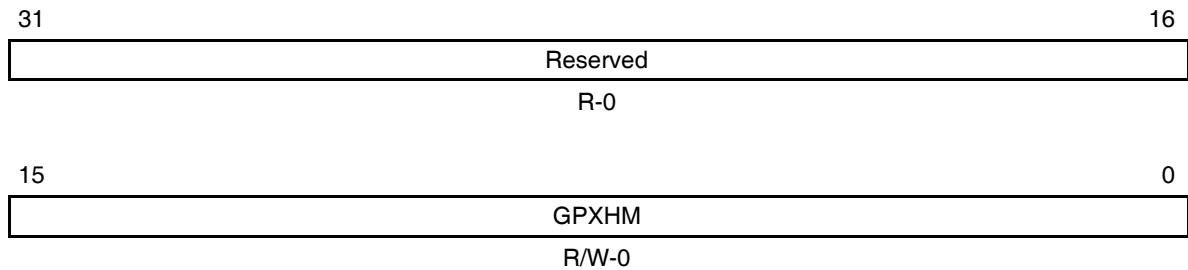

Legend: R/W = Read/Write; -n = value after reset

Table B–134. GPIO High Mask Register (GPHM) Field Values

Bit	Field	symval [†]	Value	Description
31–16	Reserved	–	0	Reserved. The reserved bit location is always read as zero. A value written to this field has no effect.
15–0	GPXHM	OF(value)	0	GPx high mask. Enable interrupt/event generation based on either the corresponding GPxDH or GPxVAL bit in the GPDH and GPVAL registers, respectively. Applies when the corresponding GPxEN bit is enabled as an input (GPXEN = 1 and GPXDIR = 0).
			0	Interrupt/event generation disabled for GPx. The value or transition on GPx does not cause an interrupt/event generation.
			1	Interrupt/event generation enabled for GPx.

[†] For CSL implementation, use the notation GPIO_GPHM_GPXHM_symval

B.7.6 GPIO Delta Low Register (GPD_L)

Figure B–129. GPIO Delta Low Register (GPD_L)

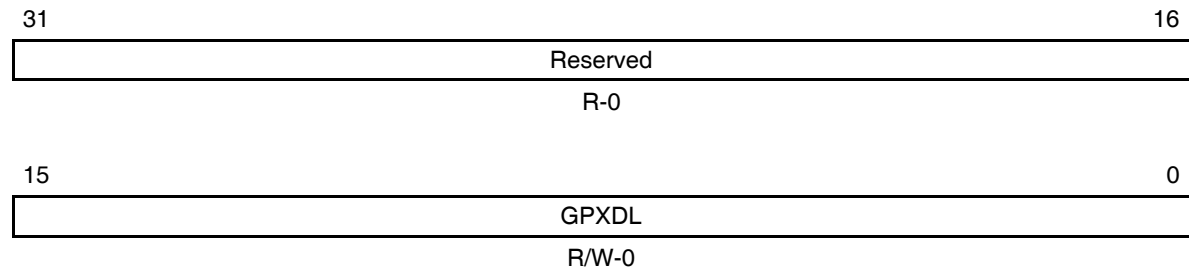

Legend: R/W = Read/Write; -n = value after reset

Table B–135. GPIO Delta Low Register (GPD_L) Field Values

Bit	Field	symval [†]	Value	Description
31–16	Reserved	–	0	Reserved. The reserved bit location is always read as zero. A value written to this field has no effect.
15–0	GPXDL	OF(value)	0	A high-to-low transition is not detected on GPx.
			1	A high-to-low transition is detected on GPx.

[†] For CSL implementation, use the notation GPIO_GPD_L_GPXDL_symval

B.7.7 GPIO Low Mask Register (GPLM)

Figure B–130. GPIO Low Mask Register (GPLM)

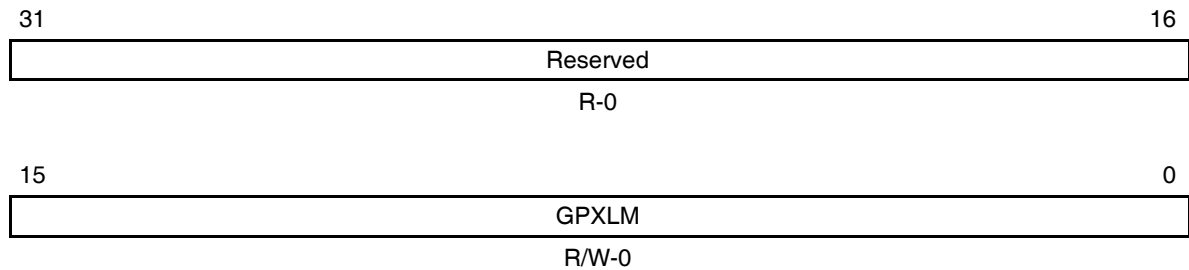

Legend: R/W = Read/Write; -n = value after reset

Table B–136. GPIO Low Mask Register (GPLM) Field Values

Bit	Field	symval [†]	Value	Description
31–16	Reserved	–	0	Reserved. The reserved bit location is always read as zero. A value written to this field has no effect.
15–0	GPXLM	OF(value)	0	GPx low mask. Enable interrupt/event generation based on either the corresponding GPXDL or <i>inverted</i> GPXVAL bit in the GPDL and GPVAL registers, respectively. Applies when the corresponding GPxEN bit is enabled as an input (GPXEN = 1 and GPXDIR = 0)
			0	Interrupt/event generation disabled for GPx. The value or transition on GPx does not cause an interrupt/event generation.
			1	Interrupt/event generation enabled for GPx.

[†] For CSL implementation, use the notation GPIO_GPLM_GPXLM_symval

B.7.8 GPIO Global Control Register (GPGC)

Figure B–131. GPIO Global Control Register (GPGC)

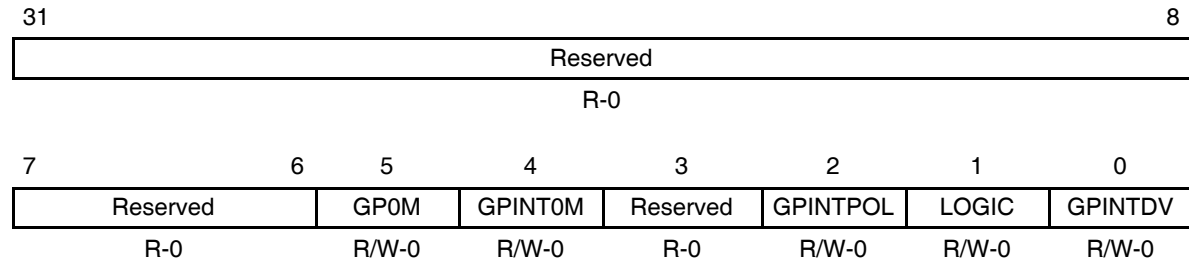

Legend: R/W = Read/Write; -n = value after reset

Table B–137. GPIO Global Control Register (GPGC) Field Values

Bit	field†	symval†	Value	Description
31–6	Reserved	–	0	Reserved. The reserved bit location is always read as zero. A value written to this field has no effect.
5	GP0M	GP0MODE	0	GPIO Mode—GP0 output is based on GP0 value (GP0VAL in GPVAL register)
		LOGICMODE	1	Logic Mode—GP0 output is based on the value of internal Logic Mode interrupt/event signal GPINT.
4	GPINT0M			GPINT0 interrupt/event generation mode.
		PASSMODE	0	Pass Through Mode—GPINT0 interrupt/event generation is based on GP0 input value (GP0VAL in the GPVAL register).
		LOGICMODE	1	Logic Mode—GPINT0 interrupt/event generation is based on GPINT.
3	Reserved	–	0	Reserved. The reserved bit location is always read as zero. A value written to this field has no effect.
2	GPINTPOL			GPINT Polarity. Applies to Logic Mode (GPINT0M = 1) only.
		LOGICTRUE	0	GPINT is active (high) when the logic combination of the GPIO inputs is evaluated true.
		LOGICFALSE	1	GPINT is active (high) when the logic combination of the GPIO inputs is evaluated false.

† For CSL implementation, use the notation GPIO_GPGC_field_symval

Table B–137. GPIO Global Control Register (GPGC) Field Values (Continued)

Bit	field [†]	symval [†]	Value	Description
1	LOGIC			GPINT Logic. Applies to Logic Mode (GPINTOM = 1) only.
		ORMODE	0	OR Mode—GPINT is generated based on the logical-OR of all GPx events enabled in the GPHM or GPLM registers.
		ANDMODE	1	AND Mode—GPINT is generated based on the logical-AND of all GPx events enabled in the GPHM or GPLM registers.
0	GPINTDV			GPINT Delta/Value Mode. Applies to Logic Mode (GPINTOM = 1) only.
		DELTAMODE	0	Delta Mode—GPINT is generated based on a logic combination of <i>transitions</i> on the GPx pins. The corresponding bits in the GPHM and/or GPLM registers must be set.
		VALUEMODE	1	Value Mode—GPINT is generated based on a logic combination of <i>values</i> on the GPx pins. The corresponding bits in the GPHM and/or GPLM registers must be set.

[†] For CSL implementation, use the notation GPIO_GPGC_*field_symval*

B.7.9 GPIO Interrupt Polarity Register (GPPOL)

Figure B–132. GPIO Interrupt Polarity Register (GPPOL)

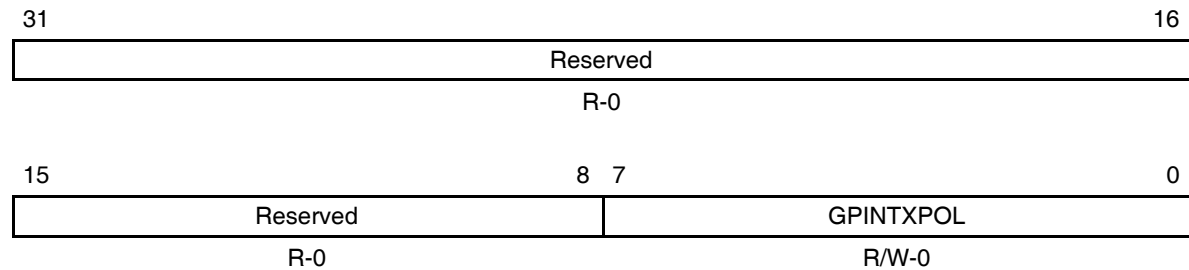

Legend: R/W = Read/Write; -n = value after reset

Table B–138. GPIO Interrupt Polarity Register (GPPOL) Field Values

Bit	Field	symval [†]	Value	Description
31–8	Reserved	–	0	Reserved. The reserved bit location is always read as zero. A value written to this field has no effect.
7–0	GPINTXPOL	OF(value)	0	GPINTx polarity bit. Applies to pass-through mode only (GPINT0M = 0 in GPGC). GPINTx is asserted (high) based on a rising edge of GPx (effectively based on the value of the corresponding GPXVAL)
			1	GPINTx is asserted (high) based on a falling edge of GPx (effectively based on the inverted value of the corresponding GPXVAL)

[†] For CSL implementation, use the notation GPIO_GPPOL_GPINTXPOL_symval

B.8 Host Port Interface (HPI) Register

Table B–139. HPI Registers for C62x/C67x DSP

Acronym	Register Name	Read/Write Access		Section
		Host	CPU	
HPID	HPI data register	R/W	–	B.8.1
HPIA	HPI address register	R/W	–	B.8.2
HPIC	HPI control register	R/W	R/W	B.8.3

Table B–140. HPI Registers for C64x DSP

Acronym	Register Name	Read/Write Access		Section
		Host	CPU	
HPID	HPI data register	R/W	–	B.8.1
HPIAW [†]	HPI address write register	R/W	R/W	B.8.2
HPIAR [†]	HPI address read register	R/W	R/W	B.8.2
HPIC	HPI control register	R/W	R/W	B.8.3
TRCTL	HPI transfer request control register	–	R/W	B.8.4

[†] Host access to the HPIA updates both HPIAW and HPIAR. The CPU can access HPIAW and HPIAR, independently.

B.8.1 HPI Data Register (HPID)

The HPI data register (HPID) contains the data that was read from the memory accessed by the HPI, if the current access is a read; HPID contains the data that is written to the memory, if the current access is a write.

B.8.2 HPI Address Register (HPIA)

The HPI address register (HPIA) contains the address of the memory accessed by the HPI at which the current access occurs. This address is a 32-bit word address with all 32-bits readable/writable. The two LSBs always function as 0, regardless of the value read from their location. The C62x/C67x HPIA is only accessible by the host, it is not mapped to the DSP memory.

The C64x HPIA is separated into two registers internally: the HPI address write register (HPIAW) and the HPI address read register (HPIAR). The HPIA is accessible by both the host and the CPU. By separating the HPIA into HPIAW and HPIAR internally, the CPU can update the read and write memory address independently to allow the host to perform read and write to different address ranges. When reading HPIA from the CPU, the value returned corresponds to the address currently being used by the HPI and DMA to transfer data inside the DSP. It is not the address for the current transfer at the external pins. Thus, reading HPIA does not indicate the status of a transfer, and should not be relied upon to do so.

For the C64x HPI, a host access to HPIA is identical to the operation of the C62x/C67x HPI. The HCNTL[1–0] control bits are set to 01b to indicate an access to HPIA. A host write to HPIA updates both HPIAW and HPIAR internally. A host read of HPIA returns the value in the most-recently-used HPIAx register. For example, if the most recent HPID access was a read, then an HPIA read by the external host returns the value in HPIAR; if the most recent HPID access was a write, then an HPIA read by the external host returns the value in HPIAW.

Systems that update HPIAR/HPIAW internally via the CPU must not allow HPIA updates via the external bus and conversely. The HPIAR/HPIAW registers can be read independently by both the CPU and the external host. The system must not allow HPID accesses via the external host while the DSP is updating the HPIAR/W registers internally. This can be controlled by any convenient means, including the use of general-purpose input/output pins to perform handshaking between the host and the DSP.

B.8.3 HPI Control Register (HPIC)

The HPI control register (HPIC) is normally the first register accessed to set configuration bits and initialize the interface. The HPIC is shown in Figure B–133, Figure B–134, and Figure B–135, and described in Table B–141. From the host's view (Figure B–133(a), Figure B–134(a), and Figure B–135(a)), HPIC is organized as a 32-bit register with two identical halves, meaning the high halfword and low halfword contents are the same. On a host write, both halfwords must be identical, except when writing the DSPINT bits in HPI16 mode. In HPI16 mode when setting DSPINT = 1, the host must only write 1 to the lower 16-bit halfword or upper 16-bit halfword, but not both. On C64x DSP in HPI16 mode, the value of DSPINT in the first halfword write is latched. The DSPINT bit must be cleared to 0 in the second halfword write. In HPI32 mode, the upper and lower halfwords must always be identical.

From the C6000 CPU view (Figure B–133(b), Figure B–134(b), and Figure B–135(b)), HPIC is a 32-bit register with only 16 bits of useful data. Only CPU writes to the lower halfword affect HPIC values and HPI operation.

On C64x DSP, the HWOB bit is writable by the CPU. Therefore, care must be taken when writing to HPIC in order not to write an undesired value to HWOB.

Figure B–133. HPI Control Register (HPIC)—C620x/C670x DSP

(a) Host Reference View

31		21	20	19	18	17	16
Reserved		FETCH	HRDY	HINT	DSPINT	HWOB	
HR-0		HR/W-0	HR-1	HR/W-0	HR/W-0	HR/W-0	
15		5	4	3	2	1	0
Reserved		FETCH	HRDY	HINT	DSPINT	HWOB	
HR-0		HR/W-0	HR-1	HR/W-0	HR/W-0	HR/W-0	

Legend: H = Host access; R = Read only; R/W = Read/Write; -n = value after reset

(b) CPU Reference View

31	Reserved						16
R-0							
15		5	4	3	2	1	0
Reserved		FETCH	HRDY	HINT	DSPINT	HWOB	
R-0		R-0	R-1	R/W-0	R/W-0	R-0	

Legend: R = Read only; R/W = Read/Write; -n = value after reset

Figure B–134. HPI Control Register (HPIC)—C621x/C671x DSP

(a) Host Reference View

31		20	19	18	17	16
Reserved		Reserved	HINT	DSPINT	HWOB	
HR-0		HR-x	HR/W-0	HR/W-0	HR/W-0	
15		4	3	2	1	0
Reserved		Reserved	HINT	DSPINT	HWOB	
HR-0		HR-x	HR/W-0	HR/W-0	HR/W-0	

Legend: H = Host access; R = Read only; R/W = Read/Write; -n = value after reset; -x = value is indeterminate after reset

(b) CPU Reference View

31		16
Reserved		
R-0		
15		0
Reserved		4
R-0		3
R-0		2
R-0		1
R-0		0
R-0		HRDY
R-0		HINT
R-0		DSPINT
R-0		HWOB
R-0		R-0

Legend: R = Read only; R/W = Read/Write; -n = value after reset

Figure B–135. HPI Control Register (HPIC)—C64x DSP

(a) Host Reference View

31	30	24	23	22	20	19	18	17	16
Reserved†	Reserved	Reserved†	Reserved		Reserved	HINT	DSPINT	HWOB	
HR/W-0	HR-0	HR-0	HR-0		HR-x	HR/W-0	HR/W-0	HR/W-0	
15	14	8	7	6	4	3	2	1	0
Reserved†	Reserved	Reserved†	Reserved		Reserved	HINT	DSPINT	HWOB	
HR/W-0	HR-0	HR-0	HR-0		HR-x	HR/W-0	HR/W-0	HR/W-0	

Legend: H = Host access; R = Read only; R/W = Read/Write; -n = value after reset; -x = value is indeterminate after reset
 † These bits are writable fields and must be written with 0; otherwise, operation is undefined.

(b) CPU Reference View

31	Reserved								16
R-0									
15	14	8	7	6	4	3	2	1	0
Reserved†	Reserved	Reserved†	Reserved		HRDY	HINT	DSPINT	HWOB	
R/W-0	R-0	R-0	R-0		R-1	R/W-0	R/W-0	R-0	

Legend: R = Read only; R/W = Read/Write; -n = value after reset
 † These bits are writable fields and must be written with 0; otherwise, operation is undefined.

Table B–141. HPI Control Register (HPIC) Field Values

Bit	field [†]	symval [†]	Value	Description
31–21	Reserved	–	0	Reserved. The reserved bit location is always read as 0.
20, 4	FETCH			Host fetch request bit.
		0	0	The value read by the host or CPU is always 0.
		1	1	The host writes a 1 to this bit to request a fetch into HPID of the word at the address pointed to by HPIA. The 1 is never actually written to this bit, however.
19, 3	HRDY			Ready signal to host bit. Not masked by HCS (as the HRDY pin is).
		0	0	The internal bus is waiting for an HPI data access request to finish.
		1	1	
18, 2	HINT			DSP-to-host interrupt bit. The inverted value of this bit determines the state of the CPU HINT output.
		0	0	CPU $\overline{\text{HINT}}$ output is logic 1.
		1	1	CPU $\overline{\text{HINT}}$ output is logic 0.
17, 1	DSPINT			The host processor-to-CPU/DMA interrupt bit.
		0	0	
		1	1	
16, 0	HWOB			Halfword ordering bit affects both data and address transfers. Only the host can modify this bit. HWOB must be initialized before the first data or address register access.
				For HPI32, HWOB is not used and the value of HWOB is irrelevant.
		0	0	The first halfword is most significant.
		1	1	The first halfword is least significant.
15–5	Reserved	–	0	Reserved. The reserved bit location is always read as 0.

[†] For CSL implementation, use the notation HPI_HPIC_field_symval

B.8.4 HPI Transfer Request Control Register (TRCTL) (C64x)

The HPI transfer request control register (TRCTL) controls how the HPI submits its requests to the EDMA subsystem. The TRCTL is shown in Figure B–246 and described in Table B–255.

To safely change the PALLOC or PRI bits in TRCTL, the TRSTALL bit needs to be used to ensure a proper transition. The following procedure must be followed to change the PALLOC or PRI bits:

- 1) Set the TRSTALL bit to 1 to stop the HPI from submitting TR requests on the current PRI level. In the same write, the desired new PALLOC and PRI fields may be specified.
- 2) Clear all EDMA event enables (EER) corresponding to both old and new PRI levels to stop EDMA from submitting TR requests on both PRI levels. Do not manually submit additional events via the EDMA.
- 3) Do not submit new QDMA requests on either old or new PRI level.
- 4) Stop L2 cache misses on either old or new PRI level. This can be done by forcing program execution or data accesses in internal memory. Another way is to have the CPU executing a tight loop that does not cause additional cache misses.
- 5) Poll the appropriate PQ bits in the priority queue status register (PQSR) of the EDMA until both queues are empty (see the *Enhanced DMA (EDMA) Controller Reference Guide*, SPRU234).
- 6) Clear the TRSTALL bit to 0 to allow the HPI to continue normal operation.

Requestors are halted on the old HPI PRI level so that memory ordering can be preserved. In this case, all pending requests corresponding to the old PRI level must be let to complete before HPI is released from stall state.

Requestors are halted on the new PRI level to ensure that at no time can the sum of all requestor allocations exceed the queue length. By halting all requestors at a given level, you can be free to modify the queue allocation counters of each requestor.

Figure B–136. HPI Transfer Request Control Register (TRCTL)

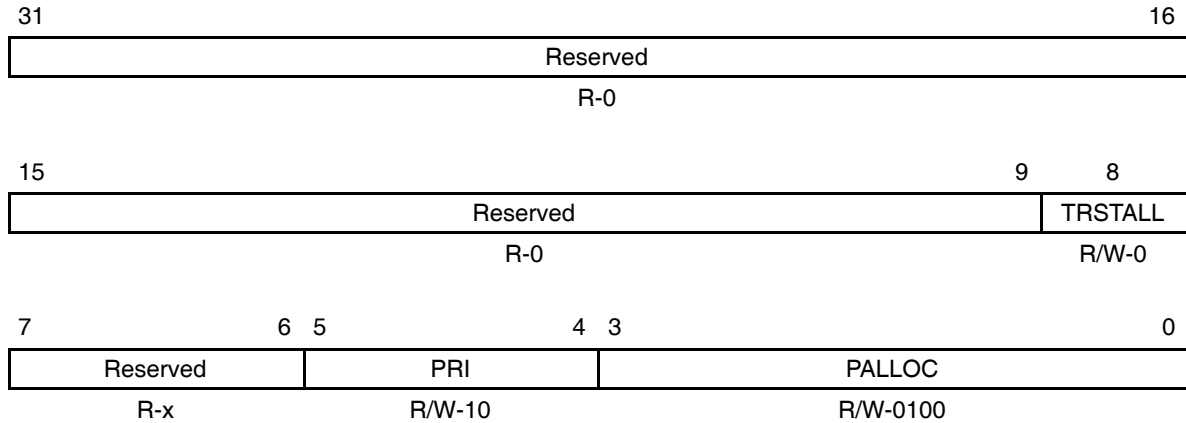

Legend: R = Read only; R/W = Read/Write; -n = value after reset; -x = value is indeterminate after reset

Table B–142. HPI Transfer Request Control Register (TRCTL) Field Values

Bit	field [†]	symval [†]	Value	Description
31–9	Reserved	–	0	Reserved. The reserved bit location is always read as 0.
8	TRSTALL		0	Allows HPI requests to be submitted to the EDMA.
			1	Halts the creation of new HPI requests to the EDMA.
7–6	Reserved	–	0	Reserved. The reserved bit location is always read as 0.
5–4	PRI		0–3h	Controls the priority queue level that HPI requests are submitted to.
			0	Urgent priority
			1h	High priority
			2h	Medium priority
			3h	Low priority
3–0	PALLOC		0–Fh	Controls the total number of outstanding requests that can be submitted by the HPI to the EDMA.

[†] For CSL implementation, use the notation HPI_TRCTL_field_symval

B.9 Inter-Integrated Circuit (I2C) Registers

Table B–143. I2C Module Registers

Acronym	Register Name	Address Offset (hex)	Section
I2COAR	I2C own address register	00	B.9.1
I2CIER	I2C interrupt enable register	04	B.9.2
I2CSTR	I2C status register	08	B.9.3
I2CCLKL	I2C clock low-time divider register	0C	B.9.4
I2CCLKH	I2C clock high-time divider register	10	B.9.4
I2CCNT	I2C data count register	14	B.9.5
I2CDRR	I2C data receive register	18	B.9.6
I2CSAR	I2C slave address register	1C	B.9.7
I2CDXR	I2C data transmit register	20	B.9.8
I2CMDR	I2C mode register	24	B.9.9
I2CISRC	I2C interrupt source register	28	B.9.10
I2CEMDR†	I2C extended mode register	2C	B.9.11
I2CPSC	I2C prescaler register	30	B.9.12
I2CPID1	I2C peripheral identification register 1	34	B.9.13
I2CPID2	I2C peripheral identification register 2	38	B.9.13
I2CPFUNC†	I2C pin function register	48	B.9.14
I2CPDIR†	I2C pin direction register	4C	B.9.15
I2CPDIN†	I2C pin data input register	50	B.9.16
I2CPDOUT†	I2C pin data output register	54	B.9.17
I2CPDSET†	I2C pin data set register	58	B.9.18
I2CPDCLR†	I2C pin data clear register	5C	B.9.19
I2CRSR	I2C receive shift register (not accessible to the CPU or EDMA)	—	—
I2CXSR	I2C transmit shift register (not accessible to the CPU or EDMA)	—	—

† Available only on C6410/C6413/C6418 DSPs.

B.9.1 I2C Own Address Register (I2COAR)

The I2C own address register (I2COAR) is a 32-bit register mapped used to specify its own slave address, which distinguishes it from other slaves connected to the I2C-bus. If the 7-bit addressing mode is selected ($XA = 0$ in I2CMDR), only bits 6–0 are used; bits 9–7 are ignored. The I2COAR is shown in Figure B–137 and described in Table B–144.

Figure B–137. I2C Own Address Register (I2COAR)

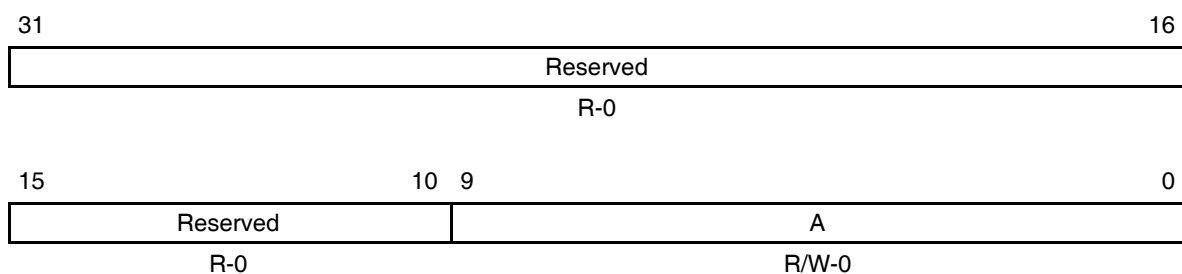

Legend: R = Read only; R/W = Read/write; -n = value after reset

Table B–144. I2C Own Address Register (I2COAR) Field Values

Bit	Field	symval [†]	Value	Description
31–10	Reserved	–	0	These Reserved bit locations are always read as zeros. A value written to this field has no effect.
9–0	A	OF(<i>value</i>)	0–7Fh	In 7-bit addressing mode ($XA = 0$ in I2CMDR): Bits 6–0 provide the 7-bit slave address of the I2C module. Bits 9–7 are ignored.
			0–3FFh	In 10-bit addressing mode ($XA = 1$ in I2CMDR): Bits 9–0 provide the 10-bit slave address of the I2C module.

[†] For CSL C macro implementation, use the notation I2C_I2COAR_A_symval

B.9.2 I2C Interrupt Enable Register (I2CIER)

The I2C interrupt enable register (I2CIER) is used by the CPU to individually enable or disable I2C interrupt requests. The I2CIER is shown in Figure B–138 and described Table B–145.

Figure B–138. I2C Interrupt Enable Register (I2CIER)

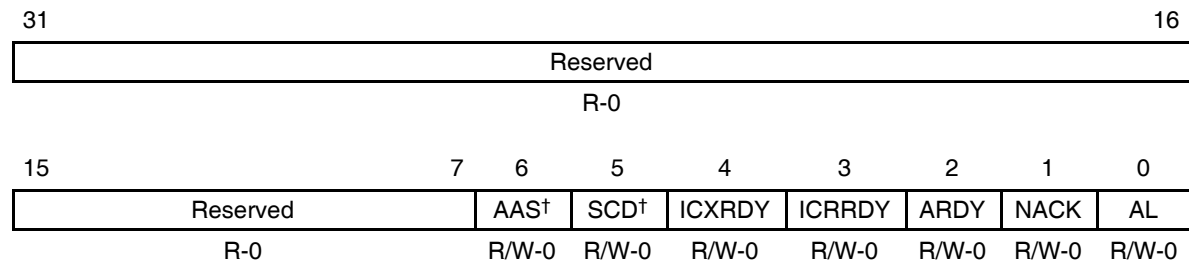

Legend: R = Read only; R/W = Read/write; -n = value after reset
[†] Available only on C6410/C6413/C6418 DSPs; reserved on all other devices.

Table B–145. I2C Interrupt Enable Register (I2CIER) Field Values

Bit	field [†]	symval [†]	Value	Description
31–7	Reserved	–	0	These Reserved bit locations are always read as zeros. A value written to this field has no effect.
6	AAS			Address as slave interrupt enable bit.
		MSK	0	Interrupt request is disabled.
		UNMSK	1	Interrupt request is enabled.
5	SCD			Stop condition detected interrupt enable bit.
		MSK	0	Interrupt request is disabled.
		UNMSK	1	Interrupt request is enabled.
4	ICXRDY			Transmit-data-ready interrupt enable bit.
		MSK	0	Interrupt request is disabled.
		UNMSK	1	Interrupt request is enabled.
3	ICRRDY			Receive-data-ready interrupt enable bit.
		MSK	0	Interrupt request is disabled.
		UNMSK	1	Interrupt request is enabled.

[†] For CSL C macro implementation, use the notation `I2C_I2CIER_field_symval`

Table B–145. I2C Interrupt Enable Register (I2CIER) Field Values (Continued)

Bit	field [†]	symval [†]	Value	Description
2	ARDY			Register-access-ready interrupt enable bit.
		MSK	0	Interrupt request is disabled.
		UNMSK	1	Interrupt request is enabled.
1	NACK			No-acknowledgement interrupt enable bit.
		MSK	0	Interrupt request is disabled.
		UNMSK	1	Interrupt request is enabled.
0	AL			Arbitration-lost interrupt enable bit
		MSK	0	Interrupt request is disabled.
		UNMSK	1	Interrupt request is enabled.

[†] For CSL C macro implementation, use the notation `I2C_I2CIER_field_symval`

B.9.3 I2C Status Register (I2CSTR)

The I2C status register (I2CSTR) is used by the CPU to determine which interrupt has occurred and to read status information. The I2CSTR is shown in Figure B–139 and described in Table B–146.

Figure B–139. I2C Status Register (I2CSTR)

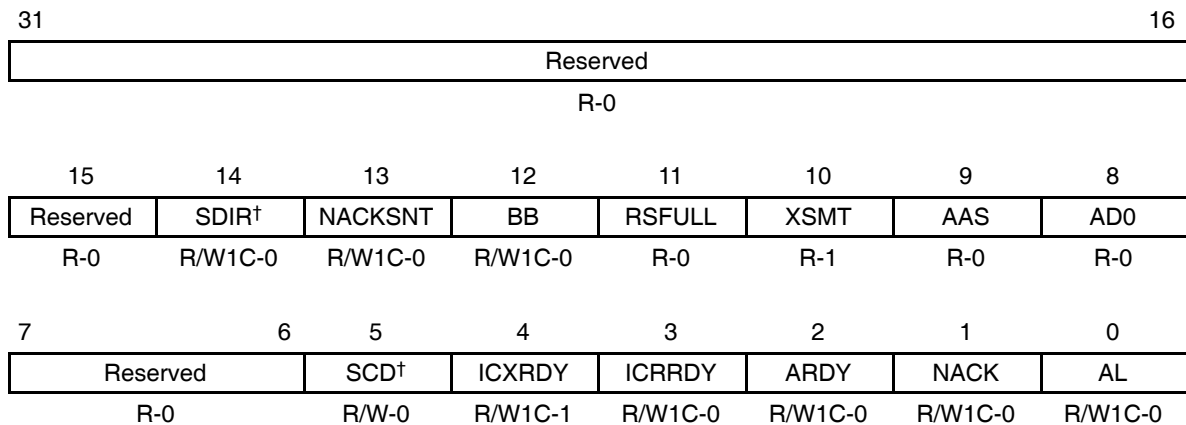

Legend: R = Read; W1C = Write 1 to clear (writing 0 has no effect); -n = value after reset

[†] Available only on C6410/C6413/C6418 DSPs; reserved on all other devices.

Table B–146. I2C Status Register (I2CSTR) Field Values

Bit	field [†]	symval [†]	Value	Description
31–15	Reserved	–	0	These Reserved bit locations are always read as zeros. A value written to this field has no effect.
14	SDIR			Slave direction bit. In digital-loopback mode, the SDIR bit is cleared to 0.
		NONE	0	I2C module is acting as a master-transmitter/receiver or a slave-receiver. SDIR is cleared by any one of the following events: <ul style="list-style-type: none"> <input type="checkbox"/> A STOP or a START condition. <input type="checkbox"/> SDIR is manually cleared. To clear this bit, write a 1 to it.
		INT CLR	1	I2C module is acting as a slave-transmitter.
13	NACKSNT			NACK sent bit is used when the I2C module is in the receiver mode. One instance in which NACKSNT is affected is when the NACK mode is used (see the description for NACKMOD in section B.9.9).
		NONE	0	NACK is not sent. NACKSNT bit is cleared by any one of the following events: <ul style="list-style-type: none"> <input type="checkbox"/> It is manually cleared. To clear this bit, write a 1 to it. <input type="checkbox"/> The I2C module is reset (either when 0 is written to the IRS bit of I2CMDR or when the whole DSP is reset).
		INT CLR	1	NACK is sent: A no-acknowledge bit was sent during the acknowledge cycle on the I ² C-bus.
12	BB			Bus busy bit. BB indicates whether the I ² C-bus is busy or is free for another data transfer.
		NONE	0	Bus is free. BB is cleared by any one of the following events: <ul style="list-style-type: none"> <input type="checkbox"/> The I2C module receives or transmits a STOP bit (bus free). <input type="checkbox"/> BB is manually cleared. To clear this bit, write a 1 to it. <input type="checkbox"/> The I2C module is reset.
		INT CLR	1	Bus is busy: The I2C module has received or transmitted a START bit on the bus.

[†] For CSL C macro implementation, use the notation I2C_I2CSTR_field_symval

Table B–146. I2C Status Register (I2CSTR) Field Values (Continued)

Bit	field [†]	symval [†]	Value	Description
11	RSFULL			Receive shift register full bit. RSFULL indicates an overrun condition during reception. Overrun occurs when the receive shift register (I2CRSR) is full with new data but the previous data has not been read from the data receive register (I2CDRR). The new data will not be copied to I2CDRR until the previous data is read. As new bits arrive from the SDA pin, they overwrite the bits in I2CRSR.
		NONE	0	No overrun is detected. RSFULL is cleared by any one of the following events: <ul style="list-style-type: none"> <input type="checkbox"/> I2CDRR is read. <input type="checkbox"/> The I2C module is reset.
		INT	1	Overrun is detected.
10	XSMT			Transmit shift register empty bit. XSMT indicates that the transmitter has experienced underflow. Underflow occurs when the transmit shift register (I2CXSR) is empty but the data transmit register (I2CDXR) has not been loaded since the last I2CDXR-to-I2CXSR transfer. The next I2CDXR-to-I2CXSR transfer will not occur until new data is in I2CDXR. If new data is not transferred in time, the previous data may be re-transmitted on the SDA pin.
		NONE	0	Underflow is detected.
		INT	1	No underflow is detected. XSMT is set by one of the following events: <ul style="list-style-type: none"> <input type="checkbox"/> Data is written to I2CDXR. <input type="checkbox"/> The I2C module is reset.
9	AAS			Addressed-as-slave bit.
		NONE	0	The AAS bit has been cleared by a repeated START condition or by a STOP condition.
		INT	1	The I2C module has recognized its own slave address or an address of all zeros (general call). The AAS bit is also set if the first data word has been received in the free data format (FDF = 1 in I2CMDR).
8	AD0			Address 0 bit.
		NONE	0	AD0 has been cleared by a START or STOP condition.
		INT	1	An address of all zeros (general call) is detected.

[†] For CSL C macro implementation, use the notation I2C_I2CSTR_field_symval

Table B–146. I2C Status Register (I2CSTR) Field Values (Continued)

Bit	field [†]	symval [†]	Value	Description
7–6	Reserved	–	0	These Reserved bit locations are always read as zeros. A value written to this field has no effect.
5	SCD			Stop condition detected bit. SCD indicates when a STOP condition has been detected on the I2C bus. The STOP condition could be generated by the I2C module or by another I2C device connected to the bus.
		NONE	0	No STOP condition has been detected. SCD is cleared by any one of the following events: <ul style="list-style-type: none"> <input type="checkbox"/> By reading INCODE bits in I2CICR as 110b. <input type="checkbox"/> SCD is manually cleared. To clear this bit, write a 1 to it.
		INT CLR	1	A STOP condition has been detected.
4	ICXRDY			Transmit-data-ready interrupt flag bit. ICXRDY indicates that the data transmit register (I2CDXR) is ready to accept new data because the previous data has been copied from I2CDXR to the transmit shift register (I2CXSR). The CPU can poll ICXRDY or use the XRDY interrupt request.
		NONE	0	I2CDXR is not ready. ICXRDY is cleared by one of the following events: <ul style="list-style-type: none"> <input type="checkbox"/> Data is written to I2CDXR. <input type="checkbox"/> ICXRDY is manually cleared. To clear this bit, write a 1 to it.
		INT CLR	1	I2CDXR is ready: Data has been copied from I2CDXR to I2CXSR. ICXRDY is forced to 1 when the I2C module is reset.

[†] For CSL C macro implementation, use the notation I2C_I2CSTR_field_symval

Table B–146. I2C Status Register (I2CSTR) Field Values (Continued)

Bit	field [†]	symval [†]	Value	Description
3	ICRRDY			Receive-data-ready interrupt flag bit. ICRRDY indicates that the data receive register (I2CDRR) is ready to be read because data has been copied from the receive shift register (I2CRSR) to I2CDRR. The CPU can poll ICRRDY or use the RRDY interrupt request.
		NONE	0	I2CDRR is not ready. ICRRDY is cleared by any one of the following events: <ul style="list-style-type: none"> <input type="checkbox"/> I2CDRR is read. <input type="checkbox"/> ICRRDY is manually cleared. To clear this bit, write a 1 to it. <input type="checkbox"/> The I2C module is reset.
		INT CLR	1	I2CDRR is ready: Data has been copied from I2CRSR to I2CDRR.
2	ARDY			Register-access-ready interrupt flag bit (only applicable when the I2C module is in the master mode). ARDY indicates that the I2C module registers are ready to be accessed because the previously programmed address, data, and command values have been used. The CPU can poll ARDY or use the ARDY interrupt request.
		NONE	0	The registers are not ready to be accessed. ARDY is cleared by any one of the following events: <ul style="list-style-type: none"> <input type="checkbox"/> The I2C module starts using the current register contents. <input type="checkbox"/> ARDY is manually cleared. To clear this bit, write a 1 to it. <input type="checkbox"/> The I2C module is reset.
		INT CLR	1	The registers are ready to be accessed. In the nonrepeat mode (RM = 0 in I2CMR): If STP = 0 in I2CMR, the ARDY bit is set when the internal data counter counts down to 0. If STP = 1, ARDY is not affected (instead, the I2C module generates a STOP condition when the counter reaches 0). In the repeat mode (RM = 1): ARDY is set at the end of each data word transmitted from I2CDXR.

[†] For CSL C macro implementation, use the notation I2C_I2CSTR_field_symval

Table B–146. I2C Status Register (I2CSTR) Field Values (Continued)

Bit	field [†]	symval [†]	Value	Description
1	NACK			No-acknowledgement interrupt flag bit. NACK applies when the I2C module is a transmitter (master or slave). NACK indicates whether the I2C module has detected an acknowledge bit (ACK) or a no-acknowledge bit (NACK) from the receiver. The CPU can poll NACK or use the NACK interrupt request.
		NONE	0	ACK received/NACK is not received. This bit is cleared by any one of the following events: <ul style="list-style-type: none"> <input type="checkbox"/> An acknowledge bit (ACK) has been sent by the receiver. <input type="checkbox"/> NACK is manually cleared. To clear this bit, write a 1 to it. <input type="checkbox"/> The CPU reads the interrupt source register (I2CISR) when the register contains the code for a NACK interrupt. <input type="checkbox"/> The I2C module is reset.
		INT CLR	1	NACK bit is received. The hardware detects that a no-acknowledge (NACK) bit has been received. Note: While the I2C module performs a general call transfer, NACK is 1, even if one or more slaves send acknowledgement.
0	AL			Arbitration-lost interrupt flag bit (only applicable when the I2C module is a master-transmitter). AL primarily indicates when the I2C module has lost an arbitration contest with another master-transmitter. The CPU can poll AL or use the AL interrupt request.
		NONE	0	Arbitration is not lost. AL is cleared by any one of the following events: <ul style="list-style-type: none"> <input type="checkbox"/> AL is manually cleared. To clear this bit, write a 1 to it. <input type="checkbox"/> The CPU reads the interrupt source register (I2CISR) when the register contains the code for an AL interrupt. <input type="checkbox"/> The I2C module is reset.
		INT CLR	1	Arbitration is lost. AL is set by any one of the following events: <ul style="list-style-type: none"> <input type="checkbox"/> The I2C module senses that it has lost an arbitration with two or more competing transmitters that started a transmission almost simultaneously. <input type="checkbox"/> The I2C module attempts to start a transfer while the BB (bus busy) bit is set to 1. When AL becomes 1, the MST and STP bits of I2CMDR are cleared, and the I2C module becomes a slave-receiver.

[†] For CSL C macro implementation, use the notation I2C_I2CSTR_field_symval

B.9.4 I2C Clock Divider Registers (I2CCLKL and I2CCLKH)

When the I2C module is a master, the module clock is divided down for use as the master clock on the SCL pin. As shown in Figure B-140, the shape of the master clock depends on two divide-down values:

- ICCL in I2CCLKL (shown in Figure B-141 and described in Table B-147). For each master clock cycle, ICCL determines the amount of time the signal is low.
- ICCH in I2CCLKH (shown in Figure B-142 and described in Table B-148). For each master clock cycle, ICCH determines the amount of time the signal is high.

The frequency of the master clock can be calculated as:

$$\text{master clock frequency} = \frac{\text{module clock frequency}}{(\text{ICCL} + 6) + (\text{ICCH} + 6)}$$

Figure B-140. Roles of the Clock Divide-Down Values (ICCL and ICCH)

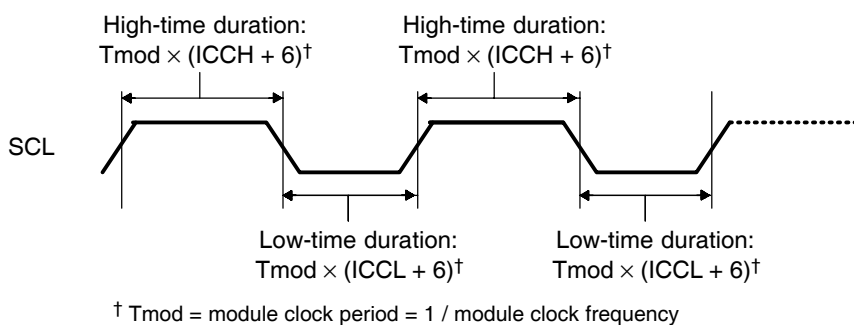
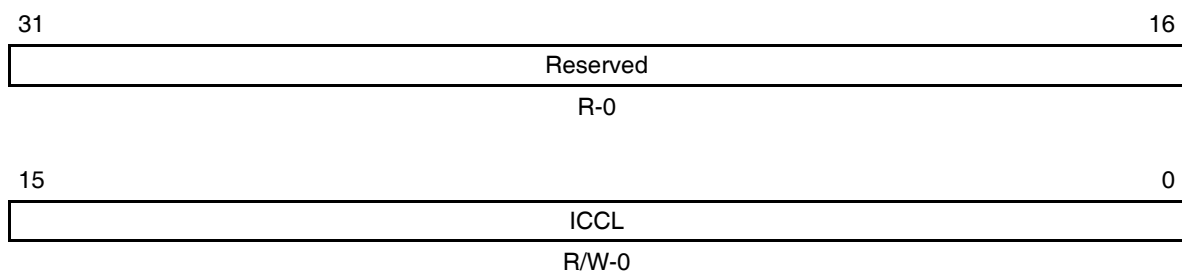

Figure B-141. I2C Clock Low-Time Divider Register (I2CCLKL)



Legend: R = Read only; R/W = Read/write; -n = value after reset

Table B–147. I2C Clock Low-Time Divider Register (I2CCLKL) Field Values

Bit	Field	symval [†]	Value	Description
31–16	Reserved	–	0	These Reserved bit locations are always read as zeros. A value written to this field has no effect.
15–0	ICCL	OF(value)	0–FFFFh	Clock low-time divide-down value of 1–65536. The period of the module clock is multiplied by (ICCL + 6) to produce the low-time duration of the master clock on the SCL pin.

[†] For CSL C macro implementation, use the notation I2C_I2CCLKL_ICCL_symval

Figure B–142. I2C Clock High-Time Divider Register (I2CCLKH)

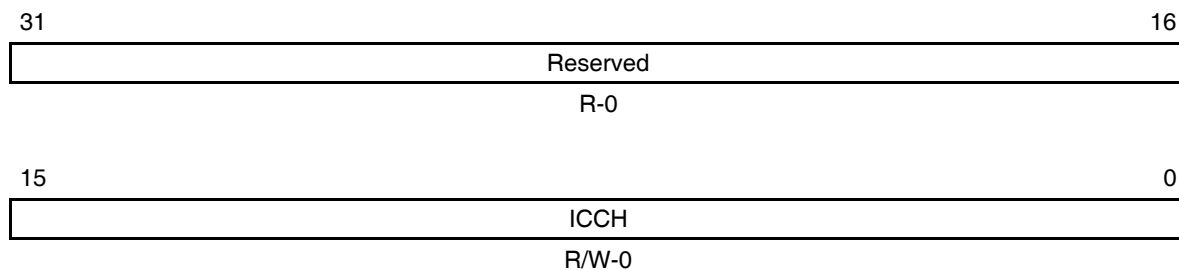

Legend: R = Read only; R/W = Read/write; -n = value after reset

Table B–148. I2C Clock High-Time Divider Register (I2CCLKH) Field Values

Bit	Field	symval [†]	Value	Description
31–16	Reserved	–	0	These Reserved bit locations are always read as zeros. A value written to this field has no effect.
15–0	ICCH	OF(value)	0–FFFFh	Clock high-time divide-down value of 1–65536. The period of the module clock is multiplied by (ICCH + 6) to produce the high-time duration of the master clock on the SCL pin.

[†] For CSL C macro implementation, use the notation I2C_I2CCLKH_ICCH_symval

B.9.5 I2C Data Count Register (I2CCNT)

The I2C data count register (I2CCNT) is used to indicate how many data words to transfer when the I2C module is configured as a master-transmitter (MST = 1 and TRX = 1 in I2CMDR) and the repeat mode is off (RM = 0 in I2CMDR). In the repeat mode (RM = 1), I2CCNT is not used. The I2CCNT is shown in Figure B–143 and described in Table B–149.

The value written to I2CCNT is copied to an internal data counter. The internal data counter is decremented by 1 for each data word transferred (I2CCNT remains unchanged). If a STOP condition is requested (STP = 1 in I2CMDR), the I2C module terminates the transfer with a STOP condition when the countdown is complete (that is, when the last data word has been transferred).

Figure B–143. I2C Data Count Register (I2CCNT)

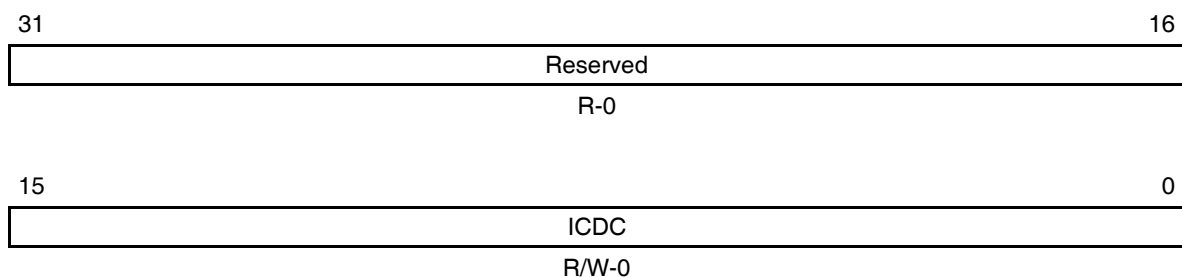

Legend: R = Read only; R/W = Read/write; -n = value after reset

Table B–149. I2C Data Count Register (I2CCNT) Field Values

Bit	Field	symval [†]	Value	Description
31–16	Reserved	–	0	These Reserved bit locations are always read as zeros. A value written to this field has no effect.
15–0	ICDC	OF(value)	0	Data count value. ICDC indicates the number of data words to transfer in the nonrepeat mode (RM = 0 in I2CMDR). The value in I2CCNT is a don't care when the RM bit in I2CMDR is set to 1.
			0	The start value loaded to the internal data counter is 65536.
			1h–FFFFh	The start value loaded to internal data counter is 1–65535.

[†] For CSL C macro implementation, use the notation I2C_I2CCNT_ICDC_symval

B.9.6 I2C Data Receive Register (I2CDRR)

The I2C data receive register (I2CDRR) is used by the DSP to read the receive data. The I2CDRR can receive a data value of up to 8 bits; data values with fewer than 8 bits are right-aligned in the D bits and the remaining D bits are undefined. The number of data bits is selected by the bit count bits (BC) of I2CMDR. The I2C receive shift register (I2CRSR) shifts in the received data from the SDA pin. Once data is complete, the I2C module copies the contents of I2CRSR into I2CDRR. The CPU and the EDMA controller cannot access I2CRSR. The I2CDRR is shown in Figure B–144 and described in Table B–150.

Figure B–144. I2C Data Receive Register (I2CDRR)

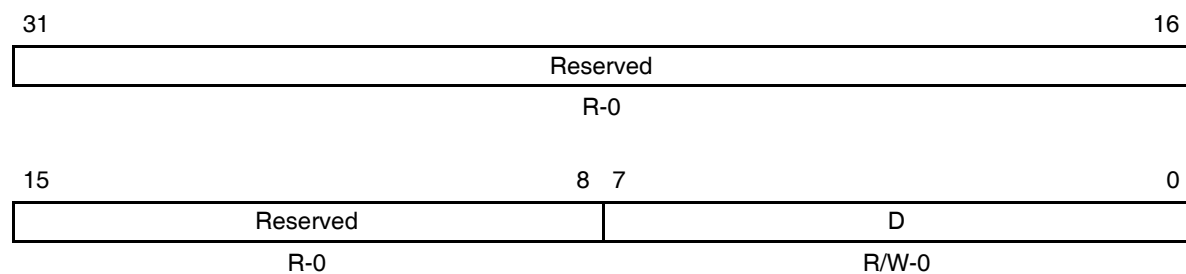

Legend: R = Read only; R/W = Read/write; -n = value after reset

Table B–150. I2C Data Receive Register (I2CDRR) Field Values

Bit	Field	symval [†]	Value	Description
31–8	Reserved	–	0	These Reserved bit locations are always read as zeros. A value written to this field has no effect.
7–0	D	OF(value)	0–FFh	Receive data.

[†] For CSL C macro implementation, use the notation I2C_I2CDRR_D_symval

B.9.7 I2C Slave Address Register (I2CSAR)

The I2C slave address register (I2CSAR) contains a 7-bit or 10-bit slave address. When the I2C module is not using the free data format (FDF = 0 in I2CMDR), it uses this address to initiate data transfers with a slave or slaves. When the address is nonzero, the address is for a particular slave. When the address is 0, the address is a general call to all slaves. If the 7-bit addressing mode is selected (XA = 0 in I2CMDR), only bits 6–0 of I2CSAR are used; bits 9–7 are ignored. The I2CSAR is shown in Figure B–145 and described in Table B–151.

Figure B–145. I2C Slave Address Register (I2CSAR)

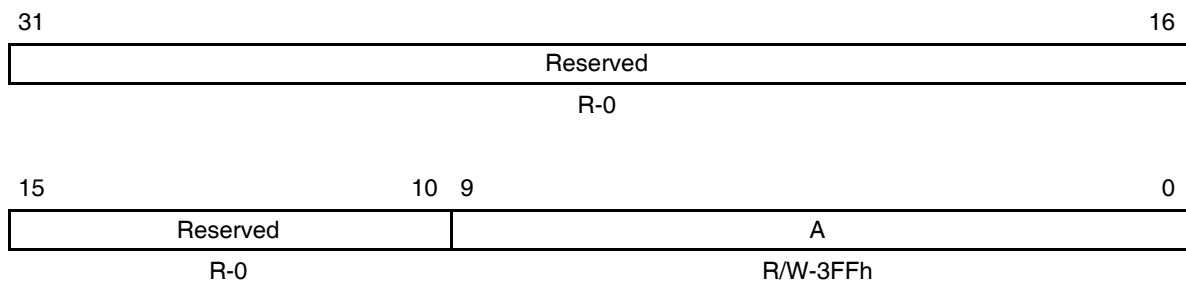

Legend: R = Read; W = Write; -n = Value after reset

Table B–151. I2C Slave Address Register (I2CSAR) Field Values

Bit	Field	symval [†]	Value	Description
31–10	Reserved	–	0	These Reserved bit locations are always read as zeros. A value written to this field has no effect.
9–0	A	OF(value)	0–7Fh	<p>In 7-bit addressing mode (XA = 0 in I2CMDR):</p> <p>Bits 6–0 provide the 7-bit slave address that the I2C module transmits when it is in the master-transmitter mode. Bits 9–7 are ignored.</p> <p>In 10-bit addressing mode (XA = 1 in I2CMDR):</p> <p>Bits 9–0 provide the 10-bit slave address that the I2C module transmits when it is in the master-transmitter mode.</p>

[†] For CSL C macro implementation, use the notation I2C_I2CSAR_A_symval

B.9.8 I2C Data Transmit Register (I2CDXR)

The DSP writes transmit data to the I2C data transmit register (I2CDXR). The I2CDXR can accept a data value of up to 8 bits. When writing a data value with fewer than 8 bits, the DSP must make sure that the value is right-aligned in the D bits. The number of data bits is selected by the bit count bits (BC) of I2CMDR. Once data is written to I2CDXR, the I2C module copies the contents of I2CDXR into the I2C transmit shift register (I2CXSR). The I2CXSR shifts out the transmit data from the SDA pin. The CPU and the EDMA controller cannot access I2CXSR. The I2CDXR is shown in Figure B–146 and described in Table B–152.

Figure B–146. I2C Data Transmit Register (I2CDXR)

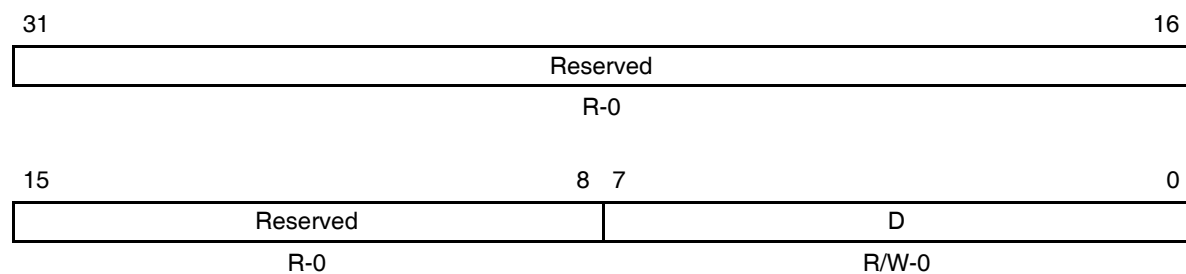

Legend: R = Read only; R/W = Read/write; -n = value after reset

Table B–152. I2C Data Transmit Register (I2CDXR) Field Values

Bit	Field	symval [†]	Value	Description
31–8	Reserved	–	0	These Reserved bit locations are always read as zeros. A value written to this field has no effect.
7–0	D	OF(value)	0–FFh	Transmit data

[†] For CSL C macro implementation, use the notation I2C_I2CDXR_D_symval

B.9.9 I2C Mode Register (I2CMDR)

The I2C mode register (I2CMDR) contains the control bits of the I2C module. The I2CMDR is shown in Figure B–147 and described in Table B–153.

Figure B–147. I2C Mode Register (I2CMDR)

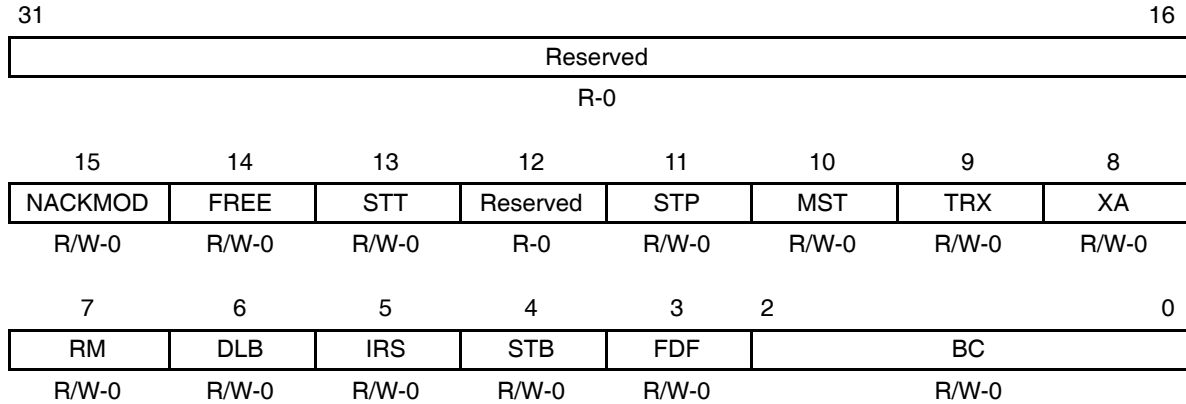

Legend: R/W = Read/write; -n = value after reset

Table B–153. I2C Mode Register (I2CMDR) Field Values

Bit	field [†]	symval [†]	Value	Description
31–16	Reserved	–	0	These Reserved bit locations are always read as zeros. A value written to this field has no effect.
15	NACKMOD			NACK mode bit is only applicable when the I2C module is acting as a receiver.
		ACK	0	In slave-receiver mode: The I2C module sends an acknowledge (ACK) bit to the transmitter during the each acknowledge cycle on the bus. The I2C module only sends a no-acknowledge (NACK) bit if you set the NACKMOD bit. In master-receiver mode: The I2C module sends an ACK bit during each acknowledge cycle until the internal data counter counts down to 0. At that point, the I2C module sends a NACK bit to the transmitter. To have a NACK bit sent earlier, you must set the NACKMOD bit.
		NACK	1	In either slave-receiver or master-receiver mode: The I2C module sends a NACK bit to the transmitter during the next acknowledge cycle on the bus. Once the NACK bit has been sent, NACKMOD is cleared. To send a NACK bit in the next acknowledge cycle, you must set NACKMOD before the rising edge of the last data bit.

[†] For CSL C macro implementation, use the notation I2C_I2CMDR_field_symval

Table B–153. I2C Mode Register (I2CMDR) Field Values (Continued)

Bit	field [†]	symval [†]	Value	Description
14	FREE	BSTOP	0	<p>This emulation mode bit is used to determine what the state of the I2C module will be when a breakpoint is encountered in the high-level language debugger.</p> <p>When I2C module is master: If SCL is low when the breakpoint occurs, the I2C module stops immediately and keeps driving SCL low, whether the I2C module is the transmitter or the receiver. If SCL is high, the I2C module waits until SCL becomes low and then stops.</p> <p>When I2C module is slave: A breakpoint forces the I2C module to stop when the current transmission/reception is complete.</p>
		RFREE	1	The I2C module runs free; that is, it continues to operate when a breakpoint occurs.
13	STT	NONE	0	<p>START condition bit (only applicable when the I2C module is a master). The RM, STT, and STP bits determine when the I2C module starts and stops data transmissions (see Table B–154). Note that the STT and STP bits can be used to terminate the repeat mode.</p> <p>In the master mode, STT is automatically cleared after the START condition has been generated.</p> <p>In the slave mode, if STT is 0, the I2C module does not monitor the bus for commands from a master. As a result, the I2C module performs no data transfers.</p>
		START	1	<p>In the master mode, setting STT to 1 causes the I2C module to generate a START condition on the I²C-bus.</p> <p>In the slave mode, if STT is 1, the I2C module monitors the bus and transmits/receives data in response to commands from a master.</p>
12	Reserved	–	0	This Reserved bit location is always read as zero. A value written to this field has no effect.

[†] For CSL C macro implementation, use the notation `I2C_I2CMDR_field_symval`

Table B–153. I2C Mode Register (I2CMDR) Field Values (Continued)

Bit	field [†]	symval [†]	Value	Description
11	STP			STOP condition bit (only applicable when the I2C module is a master). In the master mode, the RM, STT, and STP bits determine when the I2C module starts and stops data transmissions (see Table B–154). Note that the STT and STP bits can be used to terminate the repeat mode.
		NONE	0	STP is automatically cleared after the STOP condition has been generated.
		STOP	1	STP has been set by the DSP to generate a STOP condition when the internal data counter of the I2C module counts down to 0.
10	MST			Master mode bit. MST determines whether the I2C module is in the slave mode or the master mode. MST is automatically changed from 1 to 0 when the I2C master generates a STOP condition.
		SLAVE	0	Slave mode. The I2C module is a slave and receives the serial clock from the master.
		MASTER	1	Master mode. The I2C module is a master and generates the serial clock on the SCL pin.
9	TRX			Transmitter mode bit. When relevant, TRX selects whether the I2C module is in the transmitter mode or the receiver mode. Table B–155 summarizes when TRX is used and when it is a don't care.
		RCV	0	Receiver mode. The I2C module is a receiver and receives data on the SDA pin.
		XMT	1	Transmitter mode. The I2C module is a transmitter and transmits data on the SDA pin.
8	XA			Expanded address enable bit.
		7BIT	0	7-bit addressing mode (normal address mode). The I2C module transmits 7-bit slave addresses (from bits 6–0 of I2CSAR), and its own slave address has 7 bits (bits 6–0 of I2COAR).
		10BIT	1	10-bit addressing mode (expanded address mode). The I2C module transmits 10-bit slave addresses (from bits 9–0 of I2CSAR), and its own slave address has 10 bits (bits 9–0 of I2COAR).

[†] For CSL C macro implementation, use the notation `I2C_I2CMDR_field_symval`

Table B–153. I2C Mode Register (I2CMDR) Field Values (Continued)

Bit	field [†]	symval [†]	Value	Description
7	RM			Repeat mode bit (only applicable when the I2C module is a master-transmitter). The RM, STT, and STP bits determine when the I2C module starts and stops data transmissions (see Table B–154).
		NONE	0	Nonrepeat mode. The value in the data count register (I2CCNT) determines how many data words are received/transmitted by the I2C module.
		REPEAD	1	Repeat mode. Data words are continuously received/transmitted by the I2C module until the STP bit is manually set to 1, regardless of the value in I2CCNT.
6	DLB			Digital loopback mode bit. This bit disables or enables the digital loopback mode of the I2C module. The effects of this bit are shown in Figure B–148. Note that DLB in the free data format mode (DLB = 1 and FDF = 1) is not supported.
		NONE	0	Digital loopback mode is disabled.
		LOOPBACK	1	Digital loopback mode is enabled. In this mode, the MST bit must be set to 1 and data transmitted out of I2CDXR is received in I2CDRR after n DSP cycles by an internal path, where: $n = ((\text{I2C input clock frequency}/\text{module clock frequency}) \times 8)$ The transmit clock is also the receive clock. The address transmitted on the SDA pin is the address in I2COAR.
5	IRS			I2C module reset bit.
		RST	0	The I2C module is in reset/disabled. When this bit is cleared to 0, all status bits (in I2CSTR) are set to their default values.
		NRST	1	The I2C module is enabled.

[†] For CSL C macro implementation, use the notation `I2C_I2CMDR_field_symval`

Table B–153. I2C Mode Register (I2CMDR) Field Values (Continued)

Bit	field [†]	symval [†]	Value	Description
4	STB			START byte mode bit. This bit is only applicable when the I2C module is a master. As described in version 2.1 of the Philips I ² C-bus specification, the START byte can be used to help a slave that needs extra time to detect a START condition. When the I2C module is a slave, the I2C module ignores a START byte from a master, regardless of the value of the STB bit.
		NONE	0	The I2C module is not in the START byte mode.
		SET	1	The I2C module is in the START byte mode. When you set the START condition bit (STT), the I2C module begins the transfer with more than just a START condition. Specifically, it generates: <ul style="list-style-type: none"> 1) A START condition 2) A START byte (0000 0001b) 3) A dummy acknowledge clock pulse 4) A repeated START condition The I2C module sends the slave address that is in I2CSAR.
3	FDF			Free data format mode bit. Note that DLB in the free data format mode (DLB = 1 and FDF = 1) is not supported.
		NONE	0	Free data format mode is disabled. Transfers use the 7-/10-bit addressing format selected by the XA bit.
		SET	1	Free data format mode is enabled. Transfers have the free data (no address) format.

[†] For CSL C macro implementation, use the notation `I2C_I2CMDR_field_symval`

Table B–153. I2C Mode Register (I2CMDR) Field Values (Continued)

Bit	field [†]	symval [†]	Value	Description
2–0	BC	OF(value)		Bit count bits. BC defines the number of bits (1 to 8) in the next data word that is to be received or transmitted by the I2C module. The number of bits selected with BC must match the data size of the other device. Notice that when BC = 000b, a data word has 8 bits. If the bit count is less than 8, receive data is right aligned in the D bits of I2CDRR and the remaining D bits are undefined. Also, transmit data written to I2CDXR must be right aligned.
		BIT8FDF	0	8 bits per data word
		BIT1FDF	1h	1 bit per data word
		BIT2FDF	2h	2 bits per data word
		BIT3FDF	3h	3 bits per data word
		BIT4FDF	4h	4 bits per data word
		BIT5FDF	5h	5 bits per data word
		BIT6FDF	6h	6 bits per data word
		BIT7FDF	7h	7 bits per data word

[†] For CSL C macro implementation, use the notation I2C_I2CMDR_field_symval

Table B–154. Master-Transmitter/Receiver Bus Activity Defined by RM, STT, and STP Bits

I2CMDR Bit			Bus Activity [†]	Description
RM	STT	STP		
0	0	0	None	No activity
0	0	1	P	STOP condition
0	1	0	S-A-D..(n)..D	START condition, slave address, <i>n</i> data words (<i>n</i> = value in I2CCNT)
0	1	1	S-A-D..(n)..D-P	START condition, slave address, <i>n</i> data words, STOP condition (<i>n</i> = value in I2CCNT)
1	0	0	None	No activity
1	0	1	P	STOP condition
1	1	0	S-A-D-D-D.....	Repeat mode transfer: START condition, slave address, continuous data transfers until STOP condition or next START condition
1	1	1	None	Reserved bit combination (No activity)

[†] A = Address; D = Data word; P = STOP condition; S = START condition

Table B–155. How the MST and FDF Bits Affect the Role of TRX Bit

I2CMDR Bit		I2C Module State	Function of TRX Bit
MST	FDF		
0	0	In slave mode but not free data format mode	TRX is a don't care. Depending on the command from the master, the I2C module responds as a receiver or a transmitter.
0	1	In slave mode and free data format mode	The free data format mode requires that the transmitter and receiver be fixed. TRX identifies the role of the I2C module: TRX = 0: The I2C module is a receiver. TRX = 1: The I2C module is a transmitter.
1	X	In master mode; free data format mode on or off	TRX = 0: The I2C module is a receiver. TRX = 1: The I2C module is a transmitter.

Figure B–148. Block Diagram Showing the Effects of the Digital Loopback Mode (DLB) Bit

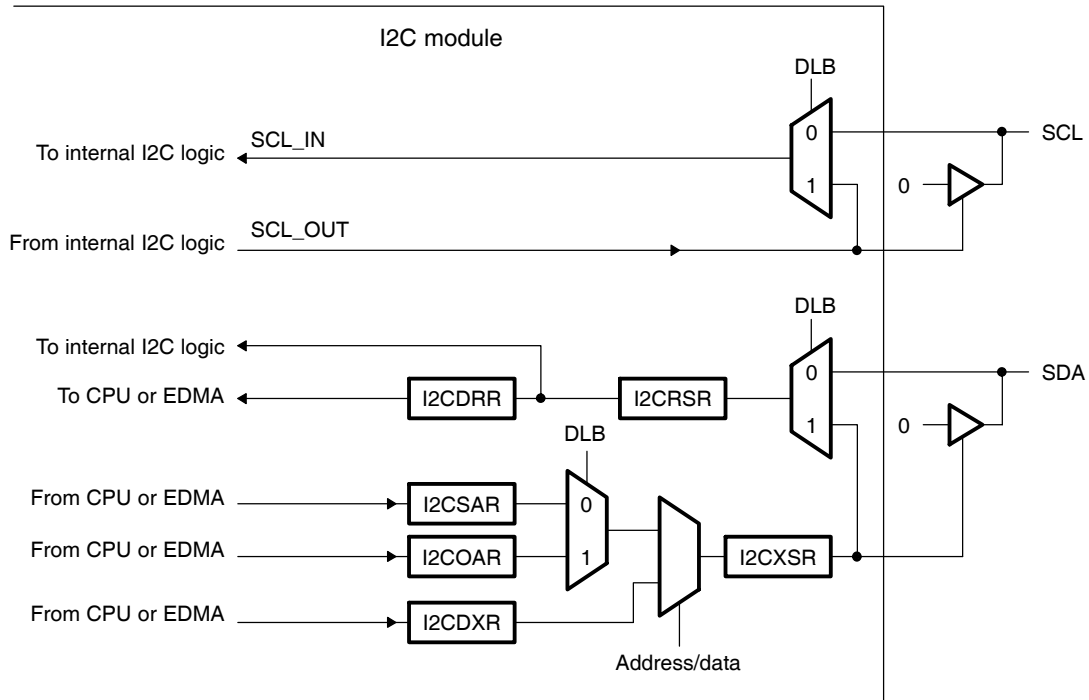

B.9.10 I2C Interrupt Source Register (I2CISRC)

The I2C interrupt source register (I2CISRC) is used by the CPU to determine which event generated the I2C interrupt. The I2CISRC is shown in Figure B–149 and described in Table B–156.

Figure B–149. I2C Interrupt Source Register (I2CISRC)

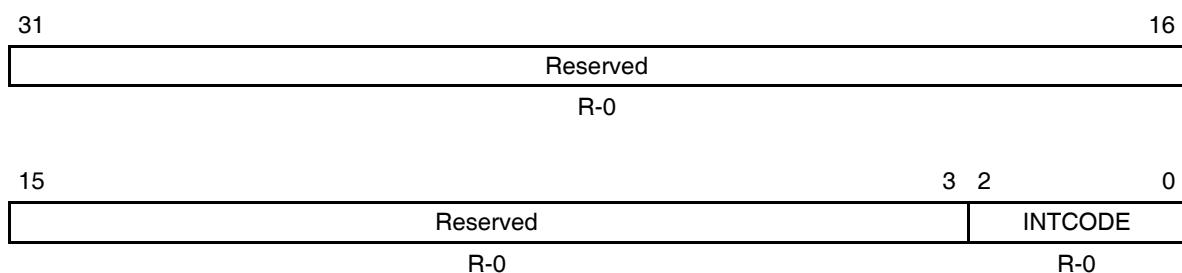

Legend: R = Read only; R/W = Read/write; -n = value after reset

Table B–156. I2C Interrupt Source Register (I2CISRC) Field Values

Bit	Field	symval [†]	Value	Description
31–3	Reserved	–	0	These Reserved bit locations are always read as zeros. Always write 0 to this field.
2–0	INTCODE			Interrupt code bits. The binary code in INTCODE indicates which event generated an I2C interrupt.
		NONE	0	None
		AL	1h	Arbitration is lost.
		NACK	2h	No-acknowledgement condition is detected.
		RAR	3h	Registers are ready to be accessed.
		RDR	4h	Receive data is ready.
		XDR	5h	Transmit data is ready.
		–	6h–7h	Reserved

[†] For CSL C macro implementation, use the notation I2C_I2CISR_INTCODE_symval

B.9.11 I2C Extended Mode Register (I2CEMDR) (C6410/C6413/C6418)

The I2C extended mode register (I2CEMDR) is used to indicate which condition generates a transmit data ready interrupt. The I2CEMDR is shown in Figure B–150 and described in Table B–157.

Figure B–150. I2C Extended Mode Register (I2CEMDR)

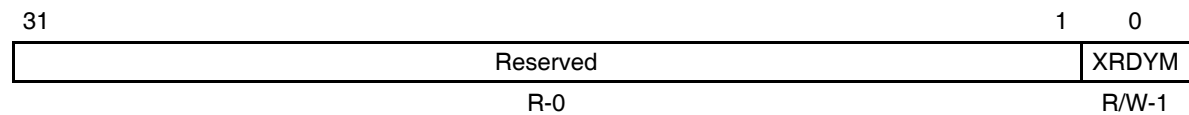

Legend: R = Read only; R/W = Read/write; -n = value after reset

Table B–157. I2C Extended Mode Register (I2CEMDR) Field Values

Bit	Field	symval [†]	Value	Description
31–1	Reserved	–	0	These reserved bit locations are always read as 0. A value written to this field has no effect.
0	XRDYM			Transmit data ready interrupt mode bit. Determines which condition generates a transmit data ready interrupt. The XRDYM bit only has an effect when the I2C module is operating as a slave-transmitter.
	MSTACK		0	The transmit data ready interrupt is generated when the master requests more data by sending an acknowledge signal after the transmission of the last data.
	DXRCPY		1	The transmit data ready interrupt is generated when the data in I2CDXR is copied to I2CXSR.

[†] For CSL C macro implementation, use the notation I2C_I2CEMDR_XRDYM_symval

B.9.12 I2C Prescaler Register (I2CPSC)

The I2C prescaler register (I2CPSC) is used for dividing down the I2C input clock to obtain the desired module clock for the operation of the I2C module. The I2CPSC is shown in Figure B–151 and described in Table B–158.

The IPSC bits must be initialized while the I2C module is in reset (IRS = 0 in I2CMDR). The prescaled frequency takes effect only when the IRS bit is changed to 1. Changing the IPSC value while IRS = 1 has no effect.

Figure B–151. I2C Prescaler Register (I2CPSC)

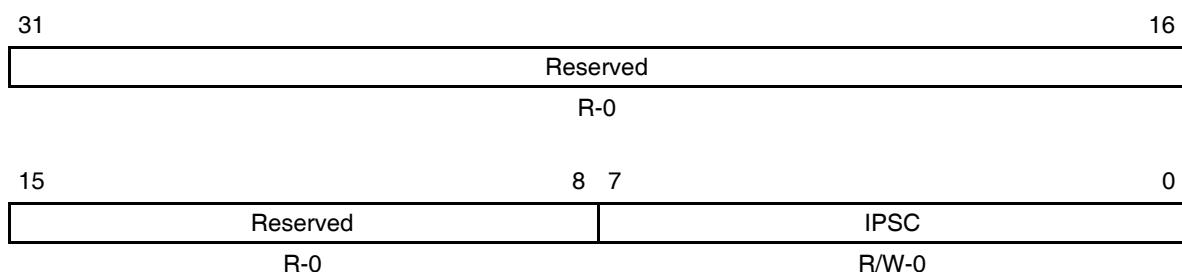

Legend: R = Read; W = Write; -n = Value after reset

Table B–158. I2C Prescaler Register (I2CPSC) Field Values

Bit	Field	symval [†]	Value	Description
31–8	Reserved	–	0	These Reserved bit locations are always read as zeros. A value written to this field has no effect.
7–0	IPSC	OF(value)	0–FFh	I2C prescaler divide-down value. IPSC determines how much the CPU clock is divided to create the module clock of the I2C module: $\text{module clock frequency} = \text{I2C input clock frequency} / (\text{IPSC} + 1)$ Note: IPSC must be initialized while the I2C module is in reset (IRS = 0 in I2CMDR).

[†] For CSL C macro implementation, use the notation I2C_I2CPSC_IPSC_symval

B.9.13 I2C Peripheral Identification Registers (I2CPID1 and I2CPID2)

The peripheral identification registers (PID) contain identification data for the I2C module. I2CPID1 is shown in Figure B–152 and described in Table B–159. I2CPID2 is shown in Figure B–153 and described in Table B–160.

Figure B–152. I2C Peripheral Identification Register 1 (I2CPID1)

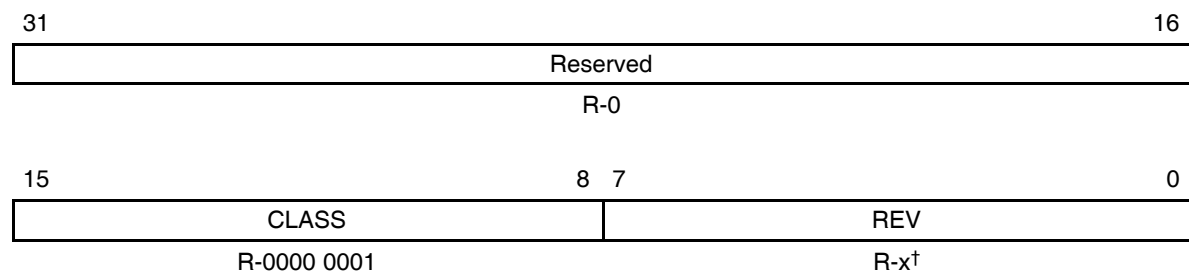

Legend: R = Read only; -x = value after reset

† See the device-specific datasheet for the default value of this field.

Table B–159. I2C Peripheral Identification Register 1 (I2CPID1) Field Values

Bit	Field	Value	Description
31–16	Reserved	0	These Reserved bit locations are always read as zeros. A value written to this field has no effect.
15–8	CLASS	1	Identifies class of peripheral. Serial port
7–0	REV	x	Identifies revision of peripheral. See the device-specific datasheet for the value.

Figure B–153. I2C Peripheral Identification Register 2 (I2CPID2)

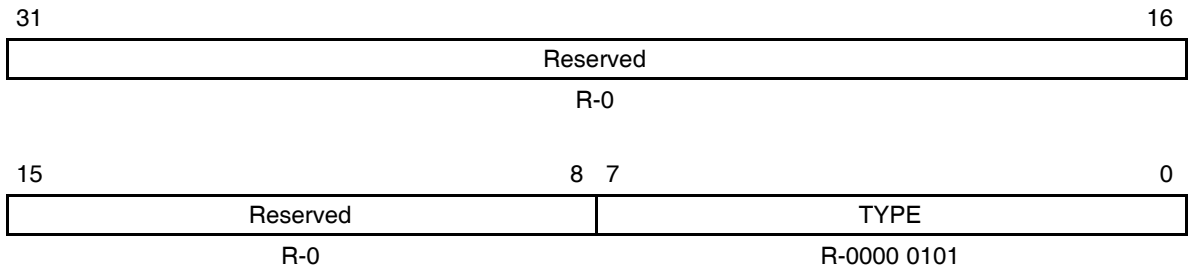

Legend: R = Read only; -x = value after reset

Table B–160. I2C Peripheral Identification Register 2 (I2CPID2) Field Values

Bit	Field	Value	Description
31–8	Reserved	0	These Reserved bit locations are always read as zeros. A value written to this field has no effect.
7–0	TYPE		Identifies type of peripheral.
		05h	I2C

B.9.14 I2C Pin Function Register (I2CPFUNC) (C6410/C6413/C6418)

The I2C pin function register (I2CPFUNC) selects the SDA and SCL pins as GPIO. The I2CPFUNC is shown in Figure B–154 and described in Table B–161.

Figure B–154. I2C Pin Function Register (I2CPFUNC)

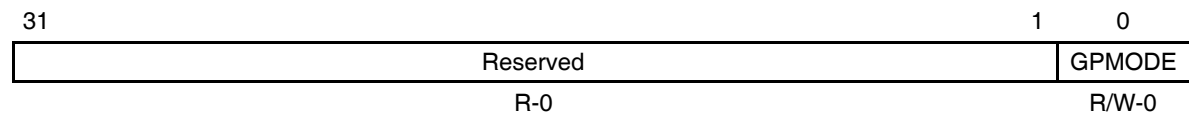

Legend: R = Read only; R/W = Read/write; -n = value after reset

Table B–161. I2C Pin Function Register (I2CPFUNC) Field Values

Bit	Field	<i>symval</i> [†]	Value	Description
31–1	Reserved	–	0	These reserved bit locations have an indeterminate value when read. A value written to this field has no effect.
0	GPMODE			GPIO mode enable bit for SCL and SDA pins. The I2C module must be placed in reset (IRS = 0 in I2CMDR) before enabling the GPIO function of the SCL and SDA pins.
		DISABLED	0	GPIO mode is disabled; SCL and SDA pins have I2C functionality.
		ENABLED	1	GPIO mode is enabled; SCL and SDA pins have GPIO functionality.

[†] For CSL C macro implementation, use the notation I2C_I2CPFUNC_GPMODE_*symval*

B.9.15 I2C Pin Direction Register (I2CPDIR) (C6410/C6413/C6418)

The I2C pin direction register (I2CPDIR) controls the direction of the SDA and SCL pins. The I2CPDIR is shown in Figure B–155 and described in Table B–162. If a bit is set to 1, the pin functions as an output; if a bit is cleared to 0, the pin functions as an input.

Figure B–155. I2C Pin Direction Register (I2CPDIR)

31	Reserved	2	1	0
	R-0		R/W-0	R/W-0

Legend: R = Read only; R/W = Read/write; -n = value after reset

Table B–162. I2C Pin Direction Register (I2CPDIR) Field Values

Bit	field [†]	symval [†]	Value	Description
31–2	Reserved	–	0	These reserved bit locations have an indeterminate value when read. A value written to this field has no effect.
1	SDADIR			SDA direction bit. Controls the direction of the SDA pin when configured as GPIO.
		INPUT	0	SDA pin functions as input.
		OUTPUT	1	SDA pin functions as output.
0	SCLDIR			SCL direction bit. Controls the direction of the SCL pin when configured as GPIO.
		INPUT	0	SCL pin functions as input.
		OUTPUT	1	SCL pin functions as output.

[†] For CSL C macro implementation, use the notation `I2C_I2CPDIR_field_symval`

B.9.16 I2C Pin Data Input Register (I2CPDIN) (C6410/C6413/C6418)

The I2C pin data input register (I2CPDIN) reflects the state of the SDA and SCL pins. The I2CPDIN is shown in Figure B–156 and described in Table B–163. When read, I2CPDIN returns the value from the pin’s input buffer regardless of the state of the corresponding I2CPFUNC or I2CPDIR bits.

Figure B–156. I2C Pin Data Input Register (I2CPDIN)

31	Reserved	2	SDAIN	1	SCLIN	0
	R-0		R/W-pin		R/W-pin	

Legend: R = Read only; R/W = Read/write; -n = value after reset; -pin = external pin value after reset

Table B–163. I2C Pin Data Input Register (I2CPDIN) Field Values

Bit	field [†]	symval [†]	Value	Description
31–2	Reserved	–	0	These reserved bit locations have an indeterminate value when read. A value written to this field has no effect.
1	SDAIN			Indicates the logic level present on the SDA pin. SDAIN is set regardless of the GPMODE setting. A value written to this bit has no effect.
		LOW	0	A logic low is present at the SDA pin.
		HIGH	1	A logic high is present at the SDA pin.
0	SCLIN			Indicates the logic level present on the SCL pin. SCLIN is set regardless of the GPMODE setting. A value written to this bit has no effect.
		LOW	0	A logic low is present at the SCL pin.
		HIGH	1	A logic high is present at the SCL pin.

[†] For CSL C macro implementation, use the notation I2C_I2CPDIN_field_symval

B.9.17 I2C Pin Data Output Register (I2CPDOUT) (C6410/C6413/C6418)

The I2C pin data output register (I2CPDOUT) determines the value driven on the SDA and SCL pins, if the pin is configured as an output. The I2CPDOUT is shown in Figure B–157 and described in Table B–164. Writes do not affect pins not configured as GPIO outputs.

The I2CPDOUT bits are set or cleared by writing to this register directly. A read of I2CPDOUT returns the value of the register not the value at the pin (that might be configured as an input). An alternative way to set bits in I2CPDOUT is to write a 1 to the corresponding bit of I2CPDSET. An alternative way to clear bits in I2CPDOUT is to write a 1 to the corresponding bit of I2CPDCLR.

I2CPDOUT has these aliases:

- I2CPDSET — writing a 1 to a bit in I2CPDSET sets the corresponding bit in I2CPDOUT to 1; writing a 0 has no effect and keeps the bits in I2CPDOUT unchanged.
- I2CPDCLR — writing a 1 to a bit in I2CPDCLR clears the corresponding bit in I2CPDOUT to 0; writing a 0 has no effect and keeps the bits in I2CPDOUT unchanged.

Figure B–157. I2C Pin Data Output Register (I2CPDOUT)

31	Reserved	2	1	0
	R-0	SDAOUT	SCLOUT	
		R/W-0	R/W-0	

Legend: R = Read only; R/W = Read/write; -n = value after reset

Table B–164. I2C Pin Data Output Register (I2CPDOUT) Field Values

Bit	field†	symval†	Value	Description
31–2	Reserved	–	0	These reserved bit locations have an indeterminate value when read. A value written to this field has no effect.
1	SDAOUT			Controls the value driven on the SDA pin when the pin is configured as an output (GPIO mode must be enabled by setting GPMODE = 1). When reading data, returns the value in the SDAOUT bit, does not return the level on the pin. When writing data, writes to the SDAOUT bit.
		LOW	0	SDA pin is driven to a logic low.
		HIGH	1	SDA pin is driven to a logic high.
0	SCLOUT			Controls the value driven on the SCL pin when the pin is configured as an output (GPIO mode must be enabled by setting GPMODE = 1). When reading data, returns the value in the SCLOUT bit, does not return the level on the pin. When writing data, writes to the SCLOUT bit.
		LOW	0	SCL pin is driven to a logic low.
		HIGH	1	SCL pin is driven to a logic high.

† For CSL C macro implementation, use the notation I2C_I2CPDOUT_field_symval

B.9.18 I2C Pin Data Set Register (I2CPDSET) (C6410/C6413/C6418)

The I2C pin data set register (I2CPDSET) is shown in Figure B–158 and described in Table B–165. I2CPDSET is an alias of the I2C pin data output register (I2CPDOUT) for writes only and provides an alternate means of driving GPIO outputs high. Writing a 1 to a bit of I2CPDSET sets the corresponding bit in I2CPDOUT. Writing a 0 has no effect. Register reads are indeterminate.

Figure B–158. I2C Pin Data Set Register (I2CPDSET)

31	Reserved	2	1	0
	R-0	SDAOUT	SCLOUT	
		R/W-0	R/W-0	

Legend: R = Read only; R/W = Read/write; -n = value after reset

Table B–165. I2C Pin Data Set Register (I2CPDSET) Field Values

Bit	field [†]	symval [†]	Value	Description
31–2	Reserved	–	0	These reserved bit locations have an indeterminate value when read. A value written to this field has no effect.
1	SDAOUT			Sets the value of the SDAOUT bit in I2CPDOUT. A write of 0 to this bit has no effect. This bit location has an indeterminate value when read.
		UNCHGN	0	No effect.
		SET	1	Sets the SDAOUT bit in I2CPDOUT to 1.
0	SCLOUT			Sets the value of the SCLOUT bit in I2CPDOUT. A write of 0 to this bit has no effect. This bit location has an indeterminate value when read.
		UNCHGN	0	No effect.
		SET	1	Sets the SCLOUT bit in I2CPDOUT to 1.

[†] For CSL C macro implementation, use the notation I2C_I2CPDSET_field_symval

B.9.19 I2C Pin Data Clear Register (I2CPDCLR) (C6410/C6413/C6418)

The I2C pin data clear register (I2CPDCLR) is shown in Figure B–159 and described in Table B–166. I2CPDCLR is an alias of the I2C pin data output register (I2CPDOUT) for writes only and provides an alternate means of driving GPIO outputs low. Writing a 1 to a bit of I2CPDCLR clears the corresponding bit in I2CPDOUT. Writing a 0 has no effect. Register reads are indeterminate.

Figure B–159. I2C Pin Data Clear Register (I2CPDCLR)

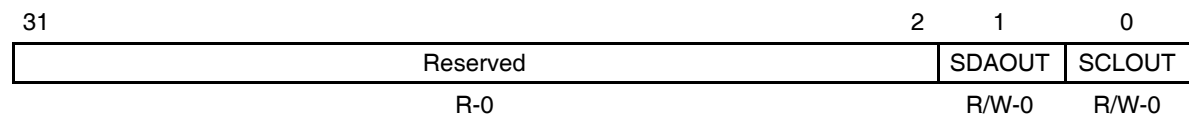

Legend: R = Read only; R/W = Read/write; -n = value after reset

Table B–166. I2C Pin Data Clear Register (I2CPDCLR) Field Values

Bit	field [†]	symval [†]	Value	Description
31–2	Reserved	–	0	These reserved bit locations have an indeterminate value when read. A value written to this field has no effect.
1	SDAOUT			Clears the value of the SDAOUT bit in I2CPDOUT. A write of 0 to this bit has no effect. This bit location has an indeterminate value when read.
		UNCHGN	0	No effect.
		CLR	1	Clears the SDAOUT bit in I2CPDOUT to 0.
0	SCLOUT			Clears the value of the SCLOUT bit in I2CPDOUT. A write of 0 to this bit has no effect. This bit location has an indeterminate value when read.
		UNCHGN	0	No effect.
		CLR	1	Clears the SCLOUT bit in I2CPDOUT to 0.

[†] For CSL C macro implementation, use the notation I2C_I2CPDCLR_field_symval

B.10 Interrupt Request (IRQ) Registers

Table B–167 shows the interrupt selector registers. The interrupt multiplexer registers determine the mapping between the interrupt sources and the CPU interrupts 4 through 15 (INT4–INT15). The external interrupt polarity register sets the polarity of external interrupts. See the device-specific datasheet for the memory address of these registers.

Table B–167. IRQ Registers

Acronym	Register Name	Section
MUXH	Interrupt multiplexer high register	B.10.1
MUXL	Interrupt multiplexer low register	B.10.2
EXTPOL	External interrupt polarity register	B.10.3

B.10.1 Interrupt Multiplexer High Register (MUXH)

The interrupt multiplexer high register (MUXH) maps the interrupt sources to particular interrupts. The MUXH is shown in Figure B–160 and described in Table B–168. The INTSEL10–INTSEL15 fields correspond to the CPU interrupts INT10–INT15. By setting the INTSEL bits to the value of the desired interrupt selection number, you can map any interrupt source to any CPU interrupt. The default values of the INTSEL bits are shown in Figure B–160. For the default mapping of interrupt sources to CPU interrupts, see the device-specific datasheet.

Figure B–160. Interrupt Multiplexer High Register (MUXH)

31	30	26	25	21	20	16
Reserved	INTSEL15	INTSEL14	INTSEL13			
R-0	R/W-0 0010	R/W-0 0001	R/W-0 0000			
15	14	10	9	5	4	0
Reserved	INTSEL12	INTSEL11	INTSEL10			
R-0	R/W-0 1011	R/W-0 1010	R/W-0 0011			

Legend: R/W-x = Read/Write-Reset value

Table B–168. Interrupt Multiplexer High Register (MUXH) Field Values

Bit	field [†]	symval [†]	Value	Description
31	Reserved	–	0	Reserved. The reserved bit location is always read as 0. A value written to this field has no effect.
30–26	INTSEL15	OF(value)	0–1Fh	Interrupt selector 15 bits. This value maps interrupt 15 to any CPU interrupt.
25–21	INTSEL14	OF(value)	0–1Fh	Interrupt selector 14 bits. This value maps interrupt 14 to any CPU interrupt.
20–16	INTSEL13	OF(value)	0–1Fh	Interrupt selector 13 bits. This value maps interrupt 13 to any CPU interrupt.
15	Reserved	–	0	Reserved. The reserved bit location is always read as 0. A value written to this field has no effect.
14–10	INTSEL12	OF(value)	0–1Fh	Interrupt selector 12 bits. This value maps interrupt 12 to any CPU interrupt.
9–5	INTSEL11	OF(value)	0–1Fh	Interrupt selector 11 bits. This value maps interrupt 11 to any CPU interrupt.
4–0	INTSEL10	OF(value)	0–1Fh	Interrupt selector 10 bits. This value maps interrupt 10 to any CPU interrupt.

[†] For CSL implementation, use the notation IRQ_MUXH_INTSEL n _symval

B.10.2 Interrupt Multiplexer Low Register (MUXL)

The interrupt multiplexer low register (MUXL) maps the interrupt sources to particular interrupts. The MUXL is shown in Figure B–161 and described in Table B–169. The INTSEL4–INTSEL9 fields correspond to the CPU interrupts INT4–INT9. By setting the INTSEL bits to the value of the desired interrupt selection number, you can map any interrupt source to any CPU interrupt. The default values of the INTSEL bits are shown in Figure B–161. For the default mapping of interrupt sources to CPU interrupts, see the device-specific datasheet.

Figure B–161. Interrupt Multiplexer Low Register (MUXL)

31	30	26	25	21	20	16	
Reserved	INTSEL9			INTSEL8			INTSEL7
R-0	R/W-0 1001			R/W-0 1000			R/W-0 0111
15	14	10	9	5	4	0	
Reserved	INTSEL6			INTSEL5			INTSEL4
R-0	R/W-0 0110			R/W-0 0101			R/W-0 0100

Legend: R/W-x = Read/Write-Reset value

Table B–169. Interrupt Multiplexer Low Register (MUXL) Field Values

Bit	field†	symval†	Value	Description
31	Reserved	–	0	Reserved. The reserved bit location is always read as 0. A value written to this field has no effect.
30–26	INTSEL9	OF(value)	0–1Fh	Interrupt selector 9 bits. This value maps interrupt 9 to any CPU interrupt.
25–21	INTSEL8	OF(value)	0–1Fh	Interrupt selector 8 bits. This value maps interrupt 8 to any CPU interrupt.
20–16	INTSEL7	OF(value)	0–1Fh	Interrupt selector 7 bits. This value maps interrupt 7 to any CPU interrupt.
15	Reserved	–	0	Reserved. The reserved bit location is always read as 0. A value written to this field has no effect.
14–10	INTSEL6	OF(value)	0–1Fh	Interrupt selector 6 bits. This value maps interrupt 6 to any CPU interrupt.
9–5	INTSEL5	OF(value)	0–1Fh	Interrupt selector 5 bits. This value maps interrupt 5 to any CPU interrupt.
4–0	INTSEL4	OF(value)	0–1Fh	Interrupt selector 4 bits. This value maps interrupt 4 to any CPU interrupt.

† For CSL implementation, use the notation IRQ_MUXL_INTSELn_symval

B.10.3 External Interrupt Polarity Register (EXTPOL)

The external interrupt polarity register (EXTPOL) allows you to change the polarity of the four external interrupts (EXT_INT4–EXT_INT7). The EXTPOL is shown in Figure B–162 and described in Table B–170. When the XIP bit is its default value of 0, a low-to-high transition on an interrupt source is recognized as an interrupt. By setting the corresponding XIP bit to 1, you can invert the external interrupt source and effectively have the CPU detect high-to-low transitions of the external interrupt. Changing an XIP bit value creates transitions on the related CPU interrupt (INT4–INT7) that the external interrupt (EXT_INT) is selected to drive. For example, if XIP4 is changed from 0 to 1 and EXT_INT4 is low or if XIP4 is changed from 1 to 0 and EXT_INT4 is high, the CPU interrupt that is mapped to EXT_INT4 becomes set. EXTPOL only affects interrupts to the CPU and has no effect on DMA events.

Figure B–162. External Interrupt Polarity Register (EXTPOL)

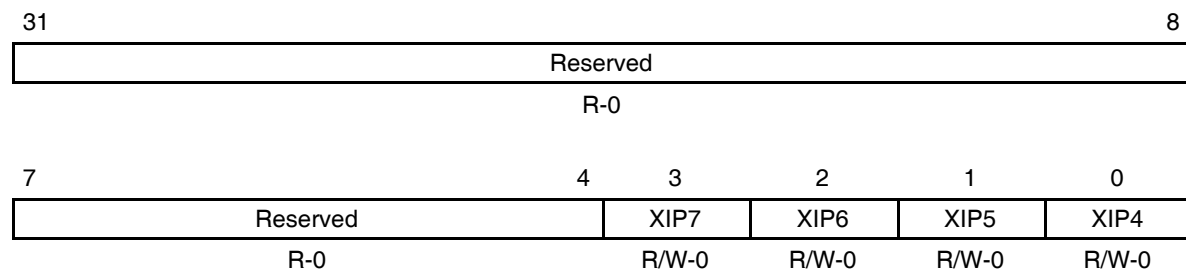

Legend: R/W-x = Read/Write-Reset value

Table B–170. External Interrupt Polarity Register (EXTPOL) Field Values

Bit	Field	symval†	Value	Description
31–4	Reserved	–	0	Reserved. The reserved bit location is always read as 0. A value written to this field has no effect.
3–0	XIP	OF(value)	0–Fh	External interrupt polarity bits. A 4-bit unsigned value used to change the polarity of the four external interrupts (EXT_INT4 to EXT_INT7).
			0	A low-to-high transition on an interrupt source is recognized as an interrupt.
			1	A high-to-low transition on an interrupt source is recognized as an interrupt.

† For CSL implementation, use the notation IRQ_EXTPOL_XIP_symval

B.11 Multichannel Audio Serial Port (McASP) Registers*Table B–171. McASP Registers Accessed Through Configuration Bus*

Acronym	Register Name	Address Offset (hex)	Section
PID	Peripheral identification register	0000	B.11.1
PWRDEMU	Power down and emulation management register	0004	B.11.2
PFUNC	Pin function register	0010	B.11.3
PDIR	Pin direction register	0014	B.11.4
PDOUT	Pin data output register	0018	B.11.5
PDIN	Read returns: Pin data input register	001C	B.11.6
PDSET	Writes affect: Pin data set register (alternate write address: PDOUT)	001C	B.11.7
PDCLR	Pin data clear register (alternate write address: PDOUT)	0020	B.11.8
GBLCTL	Global control register	0044	B.11.9
AMUTE	Audio mute control register	0048	B.11.10
DLBCTL	Digital loopback control register	004C	B.11.11
DITCTL	DIT mode control register	0050	B.11.12
RGBLCTL	Receiver global control register. Alias of GBLCTL, only receive bits are affected – allows receiver to be reset independently from transmitter	0060	B.11.13
RMASK	Receive format unit bit mask register	0064	B.11.14
RFMT	Receive bit stream format register	0068	B.11.15
AFSRCTL	Receive frame sync control register	006C	B.11.16
ACLKRCTL	Receive clock control register	0070	B.11.17
AHCLKRCTL	Receive high-frequency clock control register	0074	B.11.18
RTDM	Receive TDM time slot 0–31 register	0078	B.11.19
RINTCTL	Receiver interrupt control register	007C	B.11.20
RSTAT	Receiver status register	0080	B.11.21
RSLOT	Current receive TDM time slot register	0084	B.11.22
RCLKCHK	Receive clock check control register	0088	B.11.23

† Available only on DA6x DSP.

‡ CFG BUS only if XBUSEL = 1.

§ CFG BUS only if RBUSEL = 1.

Table B–171. McASP Registers Accessed Through Configuration Bus (Continued)

Acronym	Register Name	Address Offset (hex)	Section
REVCTL†	Receiver DMA event control register	008C	B.11.24
XGBLCTL	Transmitter global control register. Alias of GBLCTL, only transmit bits are affected– allows transmitter to be reset independently from receiver	00A0	B.11.25
XMASK	Transmit format unit bit mask register	00A4	B.11.26
XFMT	Transmit bit stream format register	00A8	B.11.27
AFSXCTL	Transmit frame sync control register	00AC	B.11.28
ACLKXCTL	Transmit clock control register	00B0	B.11.29
AHCLKXCTL	Transmit high-frequency clock control register	00B4	B.11.30
XTDM	Transmit TDM time slot 0–31 register	00B8	B.11.31
XINTCTL	Transmitter interrupt control register	00BC	B.11.32
XSTAT	Transmitter status register	00C0	B.11.33
XSLOT	Current transmit TDM time slot register	00C4	B.11.34
XCLKCHK	Transmit clock check control register	00C8	B.11.35
XEVCTL†	Transmitter DMA event control register	00CC	B.11.36
DITCSRA0	Left (even TDM time slot) channel status register (DIT mode) 0	0100	B.11.38
DITCSRA1	Left (even TDM time slot) channel status register (DIT mode) 1	0104	B.11.38
DITCSRA2	Left (even TDM time slot) channel status register (DIT mode) 2	0108	B.11.38
DITCSRA3	Left (even TDM time slot) channel status register (DIT mode) 3	010C	B.11.38
DITCSRA4	Left (even TDM time slot) channel status register (DIT mode) 4	0110	B.11.38
DITCSRA5	Left (even TDM time slot) channel status register (DIT mode) 5	0114	B.11.38
DITCSRB0	Right (odd TDM time slot) channel status register (DIT mode) 0	0118	B.11.39
DITCSRB1	Right (odd TDM time slot) channel status register (DIT mode) 1	011C	B.11.39
DITCSRB2	Right (odd TDM time slot) channel status register (DIT mode) 2	0120	B.11.39
DITCSRB3	Right (odd TDM time slot) channel status register (DIT mode) 3	0124	B.11.39
DITCSRB4	Right (odd TDM time slot) channel status register (DIT mode) 4	0128	B.11.39

† Available only on DA6x DSP.

‡ CFG BUS only if XBUSEL = 1.

§ CFG BUS only if RBUSEL = 1.

Table B–171. McASP Registers Accessed Through Configuration Bus (Continued)

Acronym	Register Name	Address Offset (hex)	Section
DITCSRB5	Right (odd TDM time slot) channel status register (DIT mode) 5	012C	B.11.39
DITUDRA0	Left (even TDM time slot) channel user data register (DIT mode) 0	0130	B.11.40
DITUDRA1	Left (even TDM time slot) channel user data register (DIT mode) 1	0134	B.11.40
DITUDRA2	Left (even TDM time slot) channel user data register (DIT mode) 2	0138	B.11.40
DITUDRA3	Left (even TDM time slot) channel user data register (DIT mode) 3	013C	B.11.40
DITUDRA4	Left (even TDM time slot) channel user data register (DIT mode) 4	0140	B.11.40
DITUDRA5	Left (even TDM time slot) channel user data register (DIT mode) 5	0144	B.11.40
DITUDRB0	Right (odd TDM time slot) channel user data register (DIT mode) 0	0148	B.11.41
DITUDRB1	Right (odd TDM time slot) channel user data register (DIT mode) 1	014C	B.11.41
DITUDRB2	Right (odd TDM time slot) channel user data register (DIT mode) 2	0150	B.11.41
DITUDRB3	Right (odd TDM time slot) channel user data register (DIT mode) 3	0154	B.11.41
DITUDRB4	Right (odd TDM time slot) channel user data register (DIT mode) 4	0158	B.11.41
DITUDRB5	Right (odd TDM time slot) channel user data register (DIT mode) 5	015C	B.11.41
SRCTL0	Serializer control register 0	0180	B.11.37
SRCTL1	Serializer control register 1	0184	B.11.37
SRCTL2	Serializer control register 2	0188	B.11.37
SRCTL3	Serializer control register 3	018C	B.11.37
SRCTL4	Serializer control register 4	0190	B.11.37
SRCTL5	Serializer control register 5	0194	B.11.37
SRCTL6	Serializer control register 6	0198	B.11.37
SRCTL7	Serializer control register 7	019C	B.11.37
SRCTL8†	Serializer control register 8	01A0	B.11.37
SRCTL9†	Serializer control register 9	01A4	B.11.37
SRCTL10†	Serializer control register 10	01A8	B.11.37
SRCTL11†	Serializer control register 11	01AC	B.11.37

† Available only on DA6x DSP.

‡ CFG BUS only if XBUSEL = 1.

§ CFG BUS only if RBUSEL = 1.

Table B–171. McASP Registers Accessed Through Configuration Bus (Continued)

Acronym	Register Name	Address Offset (hex)	Section
SRCTL12†	Serializer control register 12	01B0	B.11.37
SRCTL13†	Serializer control register 13	01B4	B.11.37
SRCTL14†	Serializer control register 14	01B8	B.11.37
SRCTL15†	Serializer control register 15	01BC	B.11.37
XBUF0‡	Transmit buffer register for serializer 0	0200	B.11.42
XBUF1‡	Transmit buffer register for serializer 1	0204	B.11.42
XBUF2‡	Transmit buffer register for serializer 2	0208	B.11.42
XBUF3‡	Transmit buffer register for serializer 3	020C	B.11.42
XBUF4‡	Transmit buffer register for serializer 4	0210	B.11.42
XBUF5‡	Transmit buffer register for serializer 5	0214	B.11.42
XBUF6‡	Transmit buffer register for serializer 6	0218	B.11.42
XBUF7‡	Transmit buffer register for serializer 7	021C	B.11.42
XBUF8†‡	Transmit buffer register for serializer 8	0220	B.11.42
XBUF9†‡	Transmit buffer register for serializer 9	0224	B.11.42
XBUF10†‡	Transmit buffer register for serializer 10	0228	B.11.42
XBUF11†‡	Transmit buffer register for serializer 11	022C	B.11.42
XBUF12†‡	Transmit buffer register for serializer 12	0230	B.11.42
XBUF13†‡	Transmit buffer register for serializer 13	0234	B.11.42
XBUF14†‡	Transmit buffer register for serializer 14	0238	B.11.42
XBUF15†‡	Transmit buffer register for serializer 15	023C	B.11.42
RBUF0§	Receive buffer register for serializer 0	0280	B.11.43
RBUF1§	Receive buffer register for serializer 1	0284	B.11.43
RBUF2§	Receive buffer register for serializer 2	0288	B.11.43
RBUF3§	Receive buffer register for serializer 3	028C	B.11.43
RBUF4§	Receive buffer register for serializer 4	0290	B.11.43

† Available only on DA6x DSP.

‡ CFG BUS only if XBUSEL = 1.

§ CFG BUS only if RBUSEL = 1.

Table B–171. McASP Registers Accessed Through Configuration Bus (Continued)

Acronym	Register Name	Address Offset (hex)	Section
RBUF5 [§]	Receive buffer register for serializer 5	0294	B.11.43
RBUF6 [§]	Receive buffer register for serializer 6	0298	B.11.43
RBUF7 [§]	Receive buffer register for serializer 7	029C	B.11.43
RBUF8 ^{†§}	Receive buffer register for serializer 8	02A0	B.11.43
RBUF9 ^{†§}	Receive buffer register for serializer 9	02A4	B.11.43
RBUF10 ^{†§}	Receive buffer register for serializer 10	02A8	B.11.43
RBUF11 ^{†§}	Receive buffer register for serializer 11	02AC	B.11.43
RBUF12 ^{†§}	Receive buffer register for serializer 12	02B0	B.11.43
RBUF13 ^{†§}	Receive buffer register for serializer 13	02B4	B.11.43
RBUF14 ^{†§}	Receive buffer register for serializer 14	02B8	B.11.43
RBUF15 ^{†§}	Receive buffer register for serializer 15	02BC	B.11.43

† Available only on DA6x DSP.

‡ CFG BUS only if XBUSEL = 1.

§ CFG BUS only if RBUSEL = 1.

Table B–172. McASP Registers Accessed Through Data Port

Hex Address	Register Name	Register Description
Read Accesses	RBUF	Receive buffer data port address. Cycles through receive serializers, skipping over transmit serializers and inactive serializers. Starts at the lowest serializer at the beginning of each time slot. DAT BUS only if XBUSEL = 0.
Write Accesses	XBUF	Transmit buffer data port address. Cycles through transmit serializers, skipping over receive and inactive serializers. Starts at the lowest serializer at the beginning of each time slot. DAT BUS only if RBUSEL = 0.

B.11.1 Peripheral Identification Register (PID)

The peripheral identification register (PID) is shown in Figure B–163 and described in Table B–173.

Figure B–163. Peripheral Identification Register (PID)

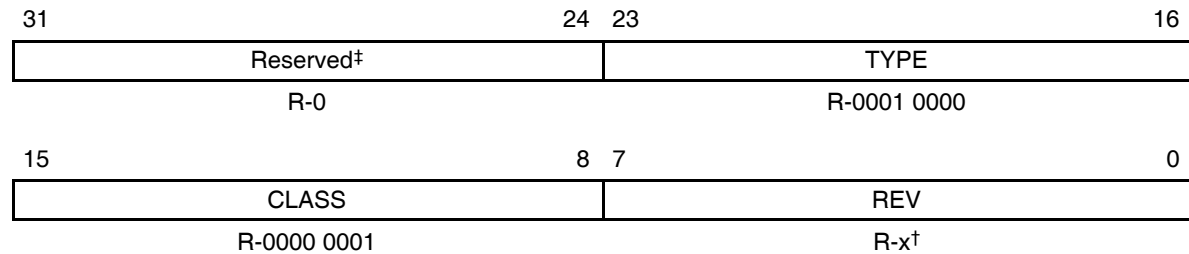

Legend: R = Read only; -n = value after reset

† See the device-specific datasheet for the default value of this field.

‡ If writing to this field, always write the default value for future device compatibility.

Table B–173. Peripheral Identification Register (PID) Field Values

Bit	field†	symval†	Value	Description
31–24	Reserved	–	0	Reserved. The reserved bit location always returns the default value. A value written to this field has no effect. If writing to this field, always write the default value for future device compatibility.
23–16	TYPE			Identifies type of peripheral.
		MCASP	10h	McASP
15–8	CLASS			Identifies class of peripheral.
		SERPORT	1	Serial port
7–0	REV			Identifies revision of peripheral.
		–	x	See the device-specific datasheet for the value.

† For CSL implementation, use the notation `MCASP_PID_field_symval`

B.11.2 Power Down and Emulation Management Register (PWRDEMU)

The power down and emulation management register (PWRDEMU) is shown in Figure B–164 and described in Table B–174.

Figure B–164. Power Down and Emulation Management Register (PWRDEMU)

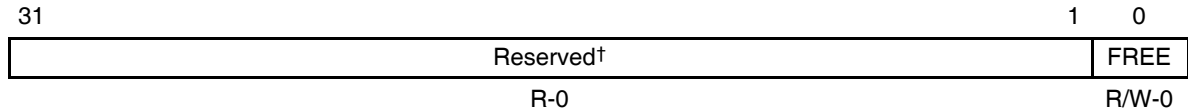

Legend: R = Read only; R/W = Read/Write; -n = value after reset

† If writing to this field, always write the default value for future device compatibility.

Table B–174. Power Down and Emulation Management Register (PWRDEMU) Field Values

Bit	Field	<i>symval</i> †	Value	Description
31–1	Reserved	–	0	Reserved. The reserved bit location always returns the default value. A value written to this field has no effect. If writing to this field, always write the default value for future device compatibility.
0	FREE			Free-running mode enable bit. This bit determines the state of the serial port clock during emulation halt.
		OFF	0	Reserved.
		ON	1	Free-running mode is enabled. Peripheral ignores the emulation suspend signal and continues to function as normal. During emulation suspend, EDMA requests continue to be generated and are serviced by the EDMA. Error conditions are flagged as usual.

† For CSL implementation, use the notation `MCASP_PWRDEMU_FREE_symval`

B.11.3 Pin Function Register (PFUNC)

The pin function register (PFUNC) specifies the function of AXR[n], ACLKX, AHCLKX, AFSX, ACLKR, AHCLKR, and AFSR pins as either a McASP pin or a general-purpose input/output (GPIO) pin. The PFUNC is shown in Figure B–165 and described in Table B–175.

Writing to Reserved Bits

Writing a value other than 0 to reserved bits in this register may cause improper device operation. This includes bits that are not implemented on a particular DSP.

Figure B–165. Pin Function Register (PFUNC)

31	30	29	28	27	26	25	24
AFSR	AHCLKR	ACLKR	AFSX	AHCLKX	ACLKX	AMUTE	Reserved†
R/W-0	R/W-0	R/W-0	R/W-0	R/W-0	R/W-0	R/W-0	R-0
							23
Reserved†							
R-0							
15	14	13	12	11	10	9	8
AXR15‡	AXR14‡	AXR13‡	AXR12‡	AXR11‡	AXR10‡	AXR9‡	AXR8‡
R/W-0	R/W-0	R/W-0	R/W-0	R/W-0	R/W-0	R/W-0	R/W-0
7	6	5	4	3	2	1	0
AXR7	AXR6	AXR5	AXR4	AXR3	AXR2	AXR1	AXR0
R/W-0	R/W-0	R/W-0	R/W-0	R/W-0	R/W-0	R/W-0	R/W-0

Legend: R = Read only; R/W = Read/Write; -n = value after reset

† If writing to this field, always write the default value for future device compatibility.

‡ On DA6x DSP only; reserved on C6713 DSP.

Table B–175. Pin Function Register (PFUNC) Field Values

Bit	field [†]	symval [‡]	Value	Description
31	AFSR			Determines if specified pin functions as McASP or GPIO.
30	AHCLKR	MCASP	0	Pin functions as McASP pin.
29	ACLKR	GPIO	1	Pin functions as GPIO pin.
28	AFSX			
27	AHCLKX			
26	ACLKX			
25	AMUTE			
24–16	Reserved	–	0	Reserved. The reserved bit location always returns the default value. A value written to this field has no effect. If writing to this field, always write the default value for future device compatibility.
15–8	AXR[15–8] [‡]			Determines if AXR[n] pin functions as McASP or GPIO.
		MCASP	0	Pin functions as McASP pin.
		GPIO	1	Pin functions as GPIO pin.
7–0	AXR[7–0]			Determines if AXR[n] pin functions as McASP or GPIO.
		MCASP	0	Pin functions as McASP pin.
		GPIO	1	Pin functions as GPIO pin.

[†] For CSL implementation, use the notation `MCASP_PFUNC_field_symval`

[‡] On DA6x DSP only; reserved on C6713 DSP.

B.11.4 Pin Direction Register (PDIR)

The pin direction register (PDIR) specifies the direction of AXR[n], ACLKX, AHCLKX, AFSX, ACLKR, AHCLKR, and AFSR pins as either an input or an output pin. The PDIR is shown in Figure B–166 and described in Table B–176.

Regardless of the pin function register (PFUNC) setting, each PDIR bit must be set to 1 for the specified pin to be enabled as an output and each PDIR bit must be cleared to 0 for the specified pin to be an input.

For example, if the McASP is configured to use an internally-generated bit clock and the clock is to be driven out to the system, the PFUNC bit must be cleared to 0 (McASP function) and the PDIR bit must be set to 1 (an output).

When AXR[n] is configured to transmit, the PFUNC bit must be cleared to 0 (McASP function) and the PDIR bit must be set to 1 (an output). Similarly, when AXR[n] is configured to receive, the PFUNC bit must be cleared to 0 (McASP function) and the PDIR bit must be cleared to 0 (an input).

Writing to Reserved Bits

Writing a value other than 0 to reserved bits in this register may cause improper device operation. This includes bits that are not implemented on a particular DSP.

Figure B–166. Pin Direction Register (PDIR)

31	30	29	28	27	26	25	24
AFSR	AHCLKR	ACLKR	AFSX	AHCLKX	ACLKX	AMUTE	Reserved†
R/W-0	R/W-0	R/W-0	R/W-0	R/W-0	R/W-0	R/W-0	R-0
23	Reserved†						16
R-0							
15	14	13	12	11	10	9	8
AXR15‡	AXR14‡	AXR13‡	AXR12‡	AXR11‡	AXR10‡	AXR9‡	AXR8‡
R/W-0	R/W-0	R/W-0	R/W-0	R/W-0	R/W-0	R/W-0	R/W-0
7	6	5	4	3	2	1	0
AXR7	AXR6	AXR5	AXR4	AXR3	AXR2	AXR1	AXR0
R/W-0	R/W-0	R/W-0	R/W-0	R/W-0	R/W-0	R/W-0	R/W-0

Legend: R = Read only; R/W = Read/Write; -n = value after reset

† If writing to this field, always write the default value for future device compatibility.

‡ On DA6x DSP only; reserved on C6713 DSP.

Table B–176. Pin Direction Register (PDIR) Field Values

Bit	field [†]	symval [‡]	Value	Description
31	AFSR			Determines if specified pin functions as an input or output.
30	AHCLKR	IN	0	Pin functions as input.
29	ACLKR	OUT	1	Pin functions as output.
28	AFSX			
27	AHCLKX			
26	ACLKX			
25	AMUTE			
24–16	Reserved	–	0	Reserved. The reserved bit location always returns the default value. A value written to this field has no effect. If writing to this field, always write the default value for future device compatibility.
15–8	AXR[15–8] [‡]			Determines if AXR[n] pin functions as an input or output.
		IN	0	Pin functions as input.
		OUT	1	Pin functions as output.
7–0	AXR[7–0]			Determines if AXR[n] pin functions as an input or output.
		IN	0	Pin functions as input.
		OUT	1	Pin functions as output.

[†] For CSL implementation, use the notation `MCASP_PDIR_field_symval`

[‡] On DA6x DSP only; reserved on C6713 DSP.

B.11.5 Pin Data Output Register (PDOUT)

The pin data output register (PDOUT) holds a value for data out at all times, and may be read back at all times. The value held by PDOUT is not affected by writing to PDIR and PFUNC. However, the data value in PDOUT is driven out onto the McASP pin only if the corresponding bit in PFUNC is set to 1 (GPIO function) and the corresponding bit in PDIR is set to 1 (output). The PDOUT is shown in Figure B–167 and described in Table B–177.

PDOUT has these aliases or alternate addresses:

- PDSET — when written to at this address, writing a 1 to a bit in PDSET sets the corresponding bit in PDOUT to 1; writing a 0 has no effect and keeps the bits in PDOUT unchanged.
- PDCLR — when written to at this address, writing a 1 to a bit in PDCLR clears the corresponding bit in PDOUT to 0; writing a 0 has no effect and keeps the bits in PDOUT unchanged.

There is only one set of data out bits, PDOUT[31–0]. The other registers, PDSET and PDCLR, are just different addresses for the same control bits, with different behaviors during writes.

Writing to Reserved Bits

Writing a value other than 0 to reserved bits in this register may cause improper device operation. This includes bits that are not implemented on a particular DSP.

Figure B–167. Pin Data Output Register (PDOUT)

31	30	29	28	27	26	25	24
AFSR	AHCLKR	ACLKR	AFSX	AHCLKX	ACLKX	AMUTE	Reserved†
R/W-0	R/W-0	R/W-0	R/W-0	R/W-0	R/W-0	R/W-0	R-0
23	Reserved†						16
R-0							
15	14	13	12	11	10	9	8
AXR15‡	AXR14‡	AXR13‡	AXR12‡	AXR11‡	AXR10‡	AXR9‡	AXR8‡
R/W-0	R/W-0	R/W-0	R/W-0	R/W-0	R/W-0	R/W-0	R/W-0
7	6	5	4	3	2	1	0
AXR7	AXR6	AXR5	AXR4	AXR3	AXR2	AXR1	AXR0
R/W-0	R/W-0	R/W-0	R/W-0	R/W-0	R/W-0	R/W-0	R/W-0

Legend: R = Read only; R/W = Read/Write; -n = value after reset

† If writing to this field, always write the default value for future device compatibility.

‡ On DA6x DSP only; reserved on C6713 DSP.

Table B–177. Pin Data Output Register (PDOUT) Field Values

Bit	field [†]	symval [†]	Value	Description
31	AFSR			Determines drive on specified output pin when the corresponding PFUNC[n] and PDIR[n] bits are set to 1.
30	AHCLKR			
29	ACLKR			When reading data, returns the corresponding bit value in PDOUT[n], does not return input from I/O pin. When writing data, writes to the corresponding PDOUT[n] bit.
28	AFSX			
27	AHCLKX	LOW	0	Pin drives low.
26	ACLKX	HIGH	1	Pin drives high.
25	AMUTE			
24–16	Reserved	–	0	Reserved. The reserved bit location always returns the default value. A value written to this field has no effect. If writing to this field, always write the default value for future device compatibility.
15–8	AXR[15–8] [‡]			Determines drive on AXR[n] pin when PFUNC[n] and PDIR[n] bits are set to 1. When reading data, returns the bit value in PDOUT[n], does not return input from I/O pin. When writing data, writes to PDOUT[n] bit.
		LOW	0	
		HIGH	1	Pin drives high.
7–0	AXR[7–0]			Determines drive on AXR[n] pin when PFUNC[n] and PDIR[n] bits are set to 1. When reading data, returns the bit value in PDOUT[n], does not return input from I/O pin. When writing data, writes to PDOUT[n] bit.
		LOW	0	
		HIGH	1	Pin drives high.

[†] For CSL implementation, use the notation MCASP_PDOUT_field_symval

[‡] On DA6x DSP only; reserved on C6713 DSP.

B.11.6 Pin Data Input Register (PDIN)

The pin data input register (PDIN) holds the I/O pin state of each of the McASP pins. PDIN allows the actual value of the pin to be read, regardless of the state of PFUNC and PDIR. The value after reset for registers 1 through 15 and 24 through 31 depends on how the pins are being driven. The PDIN is shown in Figure B-168 and described in Table B-178.

Writing to Reserved Bits

Writing a value other than 0 to reserved bits in this register may cause improper device operation. This includes bits that are not implemented on a particular DSP.

Figure B-168. Pin Data Input Register (PDIN)

31	30	29	28	27	26	25	24
AFSR	AHCLKR	ACLKR	AFSX	AHCLKX	ACLKX	AMUTE	Reserved†
R/W-0	R/W-0	R/W-0	R/W-0	R/W-0	R/W-0	R/W-0	R-0
23							16
Reserved†							
R-0							
15	14	13	12	11	10	9	8
AXR15‡	AXR14‡	AXR13‡	AXR12‡	AXR11‡	AXR10‡	AXR9‡	AXR8‡
R/W-0	R/W-0	R/W-0	R/W-0	R/W-0	R/W-0	R/W-0	R/W-0
7	6	5	4	3	2	1	0
AXR7	AXR6	AXR5	AXR4	AXR3	AXR2	AXR1	AXR0
R/W-0	R/W-0	R/W-0	R/W-0	R/W-0	R/W-0	R/W-0	R/W-0

Legend: R = Read only; R/W = Read/Write; -n = value after reset

† If writing to this field, always write the default value for future device compatibility.

‡ On DA6x DSP only; reserved on C6713 DSP.

Table B–178. Pin Data Input Register (PDIN) Field Values

Bit	field [†]	symval [†]	Value	Description
31	AFSR			Provides logic level of the specified pin.
30	AHCLKR		0	Pin is logic low.
29	ACLKR	SET	1	Pin is logic high.
28	AFSX			
27	AHCLKX			
26	ACLKX			
25	AMUTE			
24–16	Reserved	–	0	Reserved. The reserved bit location always returns the default value. A value written to this field has no effect. If writing to this field, always write the default value for future device compatibility.
15–8	AXR[15–8] [‡]		0	Provides logic level of AXR[n] pin. Pin is logic low.
		SET	1	Pin is logic high.
7–0	AXR[7–0]		0	Provides logic level of AXR[n] pin. Pin is logic low.
		SET	1	Pin is logic high.

[†] For CSL implementation, use the notation MCASP_PDIN_field_symval

[‡] On DA6x DSP only; reserved on C6713 DSP.

B.11.7 Pin Data Set Register (PDSET)

The pin data set register (PDSET) is an alias of the pin data output register (PDOUT) for writes only. Writing a 1 to the PDSET bit sets the corresponding bit in PDOUT and, if PFUNC = 1 (GPIO function) and PDIR = 1 (output), drives a logic high on the pin. PDSET is useful for a multitasking system because it allows you to set to a logic high only the desired pin(s) within a system without affecting other I/O pins controlled by the same McASP. The PDSET is shown in Figure B-169 and described in Table B-179.

Writing to Reserved Bits

Writing a value other than 0 to reserved bits in this register may cause improper device operation. This includes bits that are not implemented on a particular DSP.

Figure B-169. Pin Data Set Register (PDSET)

31	30	29	28	27	26	25	24
AFSR	AHCLKR	ACLKR	AFSX	AHCLKX	ACLKX	AMUTE	Reserved†
R/W-0	R/W-0	R/W-0	R/W-0	R/W-0	R/W-0	R/W-0	R-0
							23
Reserved†							
R-0							
15	14	13	12	11	10	9	8
AXR15†	AXR14†	AXR13†	AXR12†	AXR11†	AXR10†	AXR9†	AXR8†
R/W-0	R/W-0	R/W-0	R/W-0	R/W-0	R/W-0	R/W-0	R/W-0
7	6	5	4	3	2	1	0
AXR7	AXR6	AXR5	AXR4	AXR3	AXR2	AXR1	AXR0
R/W-0	R/W-0	R/W-0	R/W-0	R/W-0	R/W-0	R/W-0	R/W-0

Legend: R = Read only; R/W = Read/Write; -n = value after reset

† If writing to this field, always write the default value for future device compatibility.

† On DA6x DSP only; reserved on C6713 DSP.

Table B–179. Pin Data Set Register (PDSET) Field Values

Bit	field [†]	symval [†]	Value	Description
31	AFSR			Allows the corresponding PDOUT[n] bit to be set to a logic high without affecting other I/O pins controlled by the same port.
30	AHCLKR			
29	ACLKR		0	No effect.
28	AFSX	SET	1	Sets corresponding PDOUT[n] bit to 1.
27	AHCLKX			
26	ACLKX			
25	AMUTE			
24–16	Reserved	–	0	Reserved. The reserved bit location always returns the default value. A value written to this field has no effect. If writing to this field, always write the default value for future device compatibility.
15–8	AXR[15–8] [‡]		0	No effect.
		SET	1	Sets PDOUT[n] bit to 1.
7–0	AXR[7–0]		0	No effect.
		SET	1	Sets PDOUT[n] bit to 1.

[†] For CSL implementation, use the notation MCASP_PDSET_field_symval

[‡] On DA6x DSP only; reserved on C6713 DSP.

B.11.8 Pin Data Clear Register (PDCLR)

The pin data clear register (PDCLR) is an alias of the pin data output register (PDOOUT) for writes only. Writing a 1 to the PDCLR bit clears the corresponding bit in PDOOUT and, if PFUNC = 1 (GPIO function) and PDIR = 1 (output), drives a logic low on the pin. PDCLR is useful for a multitasking system because it allows you to clear to a logic low only the desired pin(s) within a system without affecting other I/O pins controlled by the same McASP. The PDCLR is shown in Figure B–170 and described in Table B–180.

Writing to Reserved Bits

Writing a value other than 0 to reserved bits in this register may cause improper device operation. This includes bits that are not implemented on a particular DSP.

Figure B–170. PDCLR Pin Data Clear Register (PDCLR)

31	30	29	28	27	26	25	24
AFSR	AHCLKR	ACLKR	AFSX	AHCLKX	ACLKX	AMUTE	Reserved†
R/W-0	R/W-0	R/W-0	R/W-0	R/W-0	R/W-0	R/W-0	R-0
							23
Reserved†							
R-0							
15	14	13	12	11	10	9	8
AXR15‡	AXR14‡	AXR13‡	AXR12‡	AXR11‡	AXR10‡	AXR9‡	AXR8‡
R/W-0	R/W-0	R/W-0	R/W-0	R/W-0	R/W-0	R/W-0	R/W-0
7	6	5	4	3	2	1	0
AXR7	AXR6	AXR5	AXR4	AXR3	AXR2	AXR1	AXR0
R/W-0	R/W-0	R/W-0	R/W-0	R/W-0	R/W-0	R/W-0	R/W-0

Legend: R = Read only; R/W = Read/Write; -n = value after reset

† If writing to this field, always write the default value for future device compatibility.

‡ On DA6x DSP only; reserved on C6713 DSP.

Table B–180. Pin Data Clear Register (PDCLR) Field Values

Bit	field [†]	symval [†]	Value	Description
31	AFSR			Allows the corresponding PDOUT[n] bit to be cleared to a logic low without affecting other I/O pins controlled by the same port.
30	AHCLKR			
29	ACLKR		0	No effect.
28	AFSX	CLR	1	Clears corresponding PDOUT[n] bit to 0.
27	AHCLKX			
26	ACLKX			
25	AMUTE			
24–16	Reserved	–	0	Reserved. The reserved bit location always returns the default value. A value written to this field has no effect. If writing to this field, always write the default value for future device compatibility.
15–8	AXR[15–8] [‡]		0	Allows PDOUT[n] bit to be cleared to a logic low without affecting other I/O pins controlled by the same port.
		CLR	1	No effect.
7–0	AXR[7–0]		0	Clears PDOUT[n] bit to 0.
		CLR	1	No effect.
			1	Clears PDOUT[n] bit to 0.

[†] For CSL implementation, use the notation MCASP_PDCLR_field_symval

[‡] On DA6x DSP only; reserved on C6713 DSP.

B.11.9 Global Control Register (GBLCTL)

The global control register (GBLCTL) provides initialization of the transmit and receive sections. The GBLCTL is shown in Figure B–171 and described in Table B–181.

The bit fields in GBLCTL are synchronized and latched by the corresponding clocks (ACLKX for bits 12–8 and ACLKR for bits 4–0). Before GBLCTL is programmed, you must ensure that serial clocks are running. If the corresponding external serial clocks, ACLKX and ACLKR, are not yet running, you should select the internal serial clock source in AHCLKXCTL, AHCLKRCTL, ACLKXCTL, and ACLKRCTL before GBLCTL is programmed. Also, after programming any bits in GBLCTL you should not proceed until you have read back from GBLCTL and verified that the bits are latched in GBLCTL.

Figure B–171. Global Control Register (GBLCTL)

31	Reserved†						16
R-0							
15	13	12	11	10	9	8	
Reserved†		XFRST	XSMRST	XSRCLR	XHCLKRST	XCLKRST	
R-0		R/W-0	R/W-0	R/W-0	R/W-0	R/W-0	
7	5	4	3	2	1	0	
Reserved†		RFRST	RSMRST	RSRCLR	RHCLKRST	RCLKRST	
R-0		R/W-0	R/W-0	R/W-0	R/W-0	R/W-0	

Legend: R = Read only; R/W = Read/Write; -n = value after reset

† If writing to this field, always write the default value for future device compatibility.

Table B–181. Global Control Register (GBLCTL) Field Values

Bit	field [†]	symval [†]	Value	Description
31–13	Reserved	–	0	Reserved. The reserved bit location always returns the default value. A value written to this field has no effect. If writing to this field, always write the default value for future device compatibility.
12	XFRST			Transmit frame sync generator reset enable bit.
		RESET	0	Transmit frame sync generator is reset.
		ACTIVE	1	Transmit frame sync generator is active. When released from reset, the transmit frame sync generator begins counting serial clocks and generating frame sync as programmed.
11	XSMRST			Transmit state machine reset enable bit.
		RESET	0	Transmit state machine is held in reset. AXR[n] pin state: If PFUNC[n] = 0 and PDIR[n] = 1; then the serializer drives the AXR[n] pin to the state specified for inactive time slot (as determined by DISMOD bits in SRCTL).
		ACTIVE	1	Transmit state machine is released from reset. When released from reset, the transmit state machine immediately transfers data from XRBUF[n] to XRSR[n]. The transmit state machine sets the underrun flag (XUNDRN) in XSTAT, if XRBUF[n] have not been preloaded with data before reset is released. The transmit state machine also immediately begins detecting frame sync and is ready to transmit. Transmit TDM time slot begins at slot 0 after reset is released.
10	XSRCLR			Transmit serializer clear enable bit. By clearing then setting this bit, the transmit buffer is flushed to an empty state (XDATA = 1). If XSMRST = 1, XSRCLR = 1, XDATA = 1, and XBUF is not loaded with new data before the start of the next active time slot, an underrun will occur.
		CLEAR	0	Transmit serializers are cleared.
		ACTIVE	1	Transmit serializers are active. When the transmit serializers are first taken out of reset (XSRCLR changes from 0 to 1), the transmit data ready bit (XDATA) in XSTAT is set to indicate XBUF is ready to be written.

[†] For CSL implementation, use the notation MCASP_GBLCTL_field_symval

Table B–181. Global Control Register (GBLCTL) Field Values (Continued)

Bit	field [†]	symval [†]	Value	Description
9	XHCLKRST			Transmit high-frequency clock divider reset enable bit.
		RESET	0	Transmit high-frequency clock divider is held in reset.
		ACTIVE	1	Transmit high-frequency clock divider is running.
8	XCLKRST			Transmit clock divider reset enable bit.
		RESET	0	Transmit clock divider is held in reset. When the clock divider is in reset, it passes through a divide-by-1 of its input.
		ACTIVE	1	Transmit clock divider is running.
7–5	Reserved	–	0	Reserved. The reserved bit location always returns the default value. A value written to this field has no effect. If writing to this field, always write the default value for future device compatibility.
4	RFRST			Receive frame sync generator reset enable bit.
		RESET	0	Receive frame sync generator is reset.
		ACTIVE	1	Receive frame sync generator is active. When released from reset, the receive frame sync generator begins counting serial clocks and generating frame sync as programmed.
3	RSMRST			Receive state machine reset enable bit.
		RESET	0	Receive state machine is held in reset.
		ACTIVE	1	Receive state machine is released from reset. When released from reset, the receive state machine immediately begins detecting frame sync and is ready to receive. Receive TDM time slot begins at slot 0 after reset is released.
2	RSRCLR			Receive serializer clear enable bit. By clearing then setting this bit, the receive buffer is flushed.
		CLEAR	0	Receive serializers are cleared.
		ACTIVE	1	Receive serializers are active.
1	RHCLKRST			Receive high-frequency clock divider reset enable bit.
		RESET	0	Receive high-frequency clock divider is held in reset.
		ACTIVE	1	Receive high-frequency clock divider is running.

[†] For CSL implementation, use the notation `MCASP_GBLCTL_field_symval`

Table B–181. Global Control Register (GBLCTL) Field Values (Continued)

Bit	field [†]	symval [†]	Value	Description
0	RCLKRST			Receive clock divider reset enable bit.
		RESET	0	Receive clock divider is held in reset. When the clock divider is in reset, it passes through a divide-by-1 of its input.
		ACTIVE	1	Receive clock divider is running.

[†] For CSL implementation, use the notation MCASP_GBLCTL_field_symval

B.11.10 Audio Mute Control Register (AMUTE)

The audio mute control register (AMUTE) controls the McASP audio mute (AMUTE) output pin. The value after reset for register 4 depends on how the pins are being driven. The AMUTE is shown in Figure B–172 and described in Table B–182.

Figure B–172. Audio Mute Control Register (AMUTE)

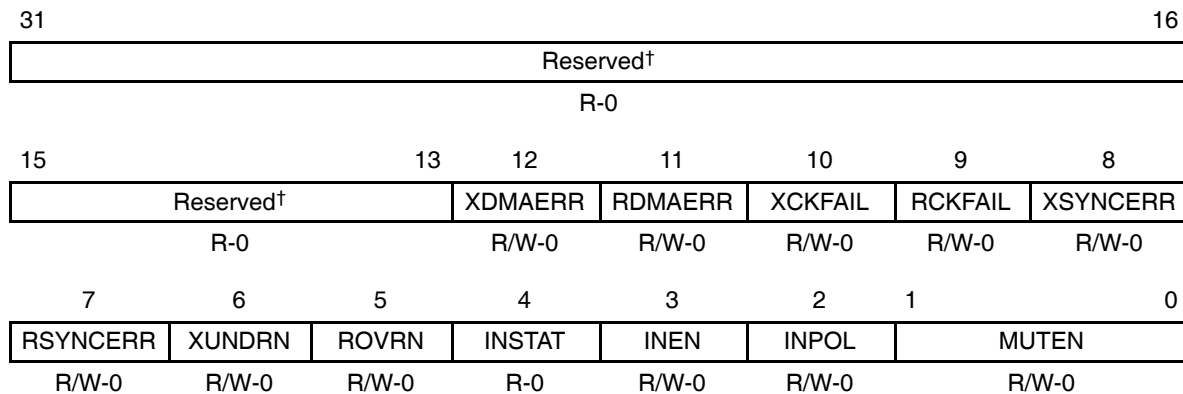

Legend: R = Read only; R/W = Read/Write; -n = value after reset

[†] If writing to this field, always write the default value for future device compatibility.

Table B–182. Audio Mute Control Register (AMUTE) Field Values

Bit	field [†]	symval [†]	Value	Description
31–13	Reserved	–	0	Reserved. The reserved bit location always returns the default value. A value written to this field has no effect. If writing to this field, always write the default value for future device compatibility.
12	XDMAERR			If transmit EDMA error (XDMAERR), drive AMUTE active enable bit.
		DISABLE	0	Drive is disabled. Detection of transmit EDMA error is ignored by AMUTE.
		ENABLE	1	Drive is enabled (active). Upon detection of transmit EDMA error, AMUTE is active and is driven according to MUTEN bit.
11	RDMAERR			If receive EDMA error (RDMAERR), drive AMUTE active enable bit.
		DISABLE	0	Drive is disabled. Detection of receive EDMA error is ignored by AMUTE.
		ENABLE	1	Drive is enabled (active). Upon detection of receive EDMA error, AMUTE is active and is driven according to MUTEN bit.
10	XCKFAIL			If transmit clock failure (XCKFAIL), drive AMUTE active enable bit.
		DISABLE	0	Drive is disabled. Detection of transmit clock failure is ignored by AMUTE.
		ENABLE	1	Drive is enabled (active). Upon detection of transmit clock failure, AMUTE is active and is driven according to MUTEN bit.
9	RCKFAIL			If receive clock failure (RCKFAIL), drive AMUTE active enable bit.
		DISABLE	0	Drive is disabled. Detection of receive clock failure is ignored by AMUTE.
		ENABLE	1	Drive is enabled (active). Upon detection of receive clock failure, AMUTE is active and is driven according to MUTEN bit.
8	XSYNCERR			If unexpected transmit frame sync error (XSYNCERR), drive AMUTE active enable bit.
		DISABLE	0	Drive is disabled. Detection of unexpected transmit frame sync error is ignored by AMUTE.
		ENABLE	1	Drive is enabled (active). Upon detection of unexpected transmit frame sync error, AMUTE is active and is driven according to MUTEN bit.

[†] For CSL implementation, use the notation `MCASP_AMUTE_field_symval`

Table B–182. Audio Mute Control Register (AMUTE) Field Values (Continued)

Bit	field [†]	symval [†]	Value	Description
7	RSYNCERR			If unexpected receive frame sync error (RSYNCERR), drive AMUTE active enable bit.
		DISABLE	0	Drive is disabled. Detection of unexpected receive frame sync error is ignored by AMUTE.
		ENABLE	1	Drive is enabled (active). Upon detection of unexpected receive frame sync error, AMUTE is active and is driven according to MUTEN bit.
6	XUNDRN			If transmit underrun error (XUNDRN), drive AMUTE active enable bit.
		DISABLE	0	Drive is disabled. Detection of transmit underrun error is ignored by AMUTE.
		ENABLE	1	Drive is enabled (active). Upon detection of transmit underrun error, AMUTE is active and is driven according to MUTEN bit.
5	ROVRN			If receiver overrun error (ROVRN), drive AMUTE active enable bit.
		DISABLE	0	Drive is disabled. Detection of receiver overrun error is ignored by AMUTE.
		ENABLE	1	Drive is enabled (active). Upon detection of receiver overrun error, AMUTE is active and is driven according to MUTEN bit.
4	INSTAT	OF(<i>value</i>)		Audio mute in (AMUTEIN) error detection status pin.
			0	AMUTEIN pin is inactive.
			1	AMUTEIN pin is active. Audio mute in error is detected.
3	INEN			Drive AMUTE active when AMUTEIN error is active (INSTAT = 1).
		DISABLE	0	Drive is disabled. AMUTEIN is ignored by AMUTE.
		ENABLE	1	Drive is enabled (active). INSTAT = 1 drives AMUTE active.
2	INPOL			Audio mute in (AMUTEIN) polarity select bit.
		ACTHIGH	0	Polarity is active high. A high on AMUTEIN sets INSTAT to 1.
		ACTLOW	1	Polarity is active low. A low on AMUTEIN sets INSTAT to 1.

[†] For CSL implementation, use the notation MCASP_AMUTE_field_symval

Table B–182. Audio Mute Control Register (AMUTE) Field Values (Continued)

Bit	field [†]	symval [†]	Value	Description
1–0	MUTEN		0–3h	AMUTE pin enable bit (unless overridden by GPIO registers).
		DISABLE	0	AMUTE pin is disabled, pin goes to tri-state condition.
		ERRHIGH	1h	AMUTE pin is driven high if error is detected.
		ERRLOW	2h	AMUTE pin is driven low if error is detected.
		–	3h	Reserved

[†] For CSL implementation, use the notation `MCASP_AMUTE_field_symval`

B.11.11 Digital Loopback Control Register (DLBCTL)

The digital loopback control register (DLBCTL) controls the internal loopback settings of the McASP in TDM mode. The DLBCTL is shown in Figure B–173 and described in Table B–183.

Figure B–173. Digital Loopback Control Register (DLBCTL)

31	Reserved†	4 3	2	1	0
	R-0	MODE	ORD	DLBEN	
		R/W-0	R/W-0	R/W-0	

Legend: R = Read only; R/W = Read/Write; -n = value after reset

† If writing to this field, always write the default value for future device compatibility.

Table B–183. Digital Loopback Control Register (DLBCTL) Field Values

Bit	field†	symval†	Value	Description
31–4	Reserved	–	0	Reserved. The reserved bit location always returns the default value. A value written to this field has no effect. If writing to this field, always write the default value for future device compatibility.
3–2	MODE		0–3h	Loopback generator mode bits. Applies only when loopback mode is enabled (DLBEN = 1).
		DEFAULT	0	Default and reserved on loopback mode (DLBEN = 1). When in non-loopback mode (DLBEN = 0), MODE should be left at default (00). When in loopback mode (DLBEN = 1), MODE = 00 is reserved and not applicable.
		XMTCLK	1h	Transmit clock and frame sync generators used by both transmit and receive sections. When in loopback mode (DLBEN = 1), MODE must be 01.
		–	2h–3h	Reserved
1	ORD			Loopback order bit when loopback mode is enabled (DLBEN = 1).
		XMTODD	0	Odd serializers N+1 transmit to even serializers N that receive. The corresponding serializers must be programmed properly.
		XMTEVEN	1	Even serializers N transmit to odd serializers N+1 that receive. The corresponding serializers must be programmed properly.
0	DLBEN			Loopback mode enable bit.
		DISABLE	0	Loopback mode is disabled.
		ENABLE	1	Loopback mode is enabled.

† For CSL implementation, use the notation MCASP_DLBCTL_field_symval

B.11.12 DIT Mode Control Register (DITCTL)

The DIT mode control register (DITCTL) controls DIT operations of the McASP. The DITCTL is shown in Figure B–174 and described in Table B–184.

Figure B–174. DIT Mode Control Register (DITCTL)

31	Reserved†	4	3	2	1	0
	R-0	VB	VA	Rsvd†	DITEN	
		R/W-0	R/W-0	R-0	R/W-0	

Legend: R = Read only; R/W = Read/Write; -n = value after reset

† If writing to this field, always write the default value for future device compatibility.

Table B–184. DIT Mode Control Register (DITCTL) Field Values

Bit	field†	symval†	Value	Description
31–4	Reserved	–	0	Reserved. The reserved bit location always returns the default value. A value written to this field has no effect. If writing to this field, always write the default value for future device compatibility.
3	VB			Valid bit for odd time slots (DIT right subframe).
		ZERO	0	V bit is 0 during odd DIT subframes.
		ONE	1	V bit is 1 during odd DIT subframes.
2	VA			Valid bit for even time slots (DIT left subframe).
		ZERO	0	V bit is 0 during even DIT subframes.
		ONE	1	V bit is 1 during even DIT subframes.
1	Reserved	–	0	Reserved. The reserved bit location always returns the default value. A value written to this field has no effect. If writing to this field, always write the default value for future device compatibility.
0	DITEN			DIT mode enable bit. DITEN should only be changed while XSMRST in GBLCTL is in reset (and for startup, XSRCLR also in reset). However, it is not necessary to reset XCLKRST or XHCLKRST in GBLCTL to change DITEN.
		TDM	0	DIT mode is disabled. Transmitter operates in TDM or burst mode.
		DIT	1	DIT mode is enabled. Transmitter operates in DIT encoded mode.

† For CSL implementation, use the notation MCASP_DITCTL_field_symval

B.11.13 Receiver Global Control Register (RGLCTL)

Alias of the global control register (GBLCTL). Writing to the receiver global control register (RGLCTL) affects only the receive bits of GBLCTL (bits 4–0). Reads from RGLCTL return the value of GBLCTL. RGLCTL allows the receiver to be reset independently from the transmitter. The RGLCTL is shown in Figure B–175 and described in Table B–185. See section B.11.9 for a detailed description of GBLCTL.

Figure B–175. Receiver Global Control Register (RGLCTL)

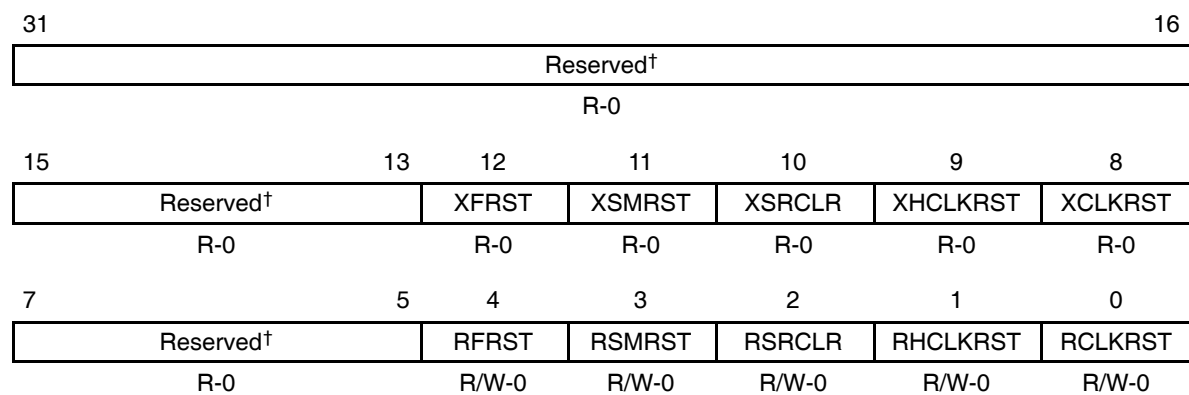

Legend: R = Read only; R/W = Read/Write; -n = value after reset
[†] If writing to this field, always write the default value for future device compatibility.

Table B–185. Receiver Global Control Register (RGLCTL) Field Values

Bit	field [†]	symval [†]	Value	Description
31–13	Reserved	–	0	Reserved. The reserved bit location always returns the default value. A value written to this field has no effect. If writing to this field, always write the default value for future device compatibility.
12	XFRST	–	x	Transmit frame sync generator reset enable bit. A read of this bit returns the XFRST bit value of GBLCTL. Writes have no effect.
11	XSMRST	–	x	Transmit state machine reset enable bit. A read of this bit returns the XSMRST bit value of GBLCTL. Writes have no effect.
10	XSRCLR	–	x	Transmit serializer clear enable bit. A read of this bit returns the XSRCLR bit value of GBLCTL. Writes have no effect.

[†] For CSL implementation, use the notation MCASP_RGLCTL_field_symval

Table B–185. Receiver Global Control Register (RGBLCTL) Field Values (Continued)

Bit	field [†]	symval [†]	Value	Description
9	XHCLKRST	–	x	Transmit high-frequency clock divider reset enable bit. A read of this bit returns the XHCLKRST bit value of GBLCTL. Writes have no effect.
8	XCLKRST	–	x	Transmit clock divider reset enable bit. a read of this bit returns the XCLKRST bit value of GBLCTL. Writes have no effect.
7–5	Reserved	–	0	Reserved. The reserved bit location always returns the default value. A value written to this field has no effect. If writing to this field, always write the default value for future device compatibility.
4	RFRST			Receive frame sync generator reset enable bit. A write to this bit affects the RFRST bit of GBLCTL.
		RESET	0	Receive frame sync generator is reset.
		ACTIVE	1	Receive frame sync generator is active.
3	RSMRST			Receive state machine reset enable bit. A write to this bit affects the RSMRST bit of GBLCTL.
		RESET	0	Receive state machine is held in reset.
		ACTIVE	1	Receive state machine is released from reset.
2	RSRCLR			Receive serializer clear enable bit. A write to this bit affects the RSRCLR bit of GBLCTL.
		CLEAR	0	Receive serializers are cleared.
		ACTIVE	1	Receive serializers are active.
1	RHCLKRST			Receive high-frequency clock divider reset enable bit. A write to this bit affects the RHCLKRST bit of GBLCTL.
		RESET	0	Receive high-frequency clock divider is held in reset.
		ACTIVE	1	Receive high-frequency clock divider is running.
0	RCLKRST			Receive clock divider reset enable bit. A write to this bit affects the RCLKRST bit of GBLCTL.
		RESET	0	Receive clock divider is held in reset.
		ACTIVE	1	Receive clock divider is running.

[†] For CSL implementation, use the notation MCASP_RGBLCTL_field_symval

B.11.14 Receive Format Unit Bit Mask Register (RMASK)

The receive format unit bit mask register (RMASK) determines which bits of the received data are masked off and padded with a known value before being read by the CPU or EDMA. The RMASK is shown in Figure B–176 and described in Table B–186.

Figure B–176. Receive Format Unit Bit Mask Register (RMASK)

31	30	29	28	27	26	25	24
RMASK31	RMASK30	RMASK29	RMASK28	RMASK27	RMASK26	RMASK25	RMASK24
R/W-0	R/W-0	R/W-0	R/W-0	R/W-0	R/W-0	R/W-0	R/W-0
23	22	21	20	19	18	17	16
RMASK23	RMASK22	RMASK21	RMASK20	RMASK19	RMASK18	RMASK17	RMASK16
R/W-0	R/W-0	R/W-0	R/W-0	R/W-0	R/W-0	R/W-0	R/W-0
15	14	13	12	11	10	9	8
RMASK15	RMASK14	RMASK13	RMASK12	RMASK11	RMASK10	RMASK9	RMASK8
R/W-0	R/W-0	R/W-0	R/W-0	R/W-0	R/W-0	R/W-0	R/W-0
7	6	5	4	3	2	1	0
RMASK7	RMASK6	RMASK5	RMASK4	RMASK3	RMASK2	RMASK1	RMASK0
R/W-0	R/W-0	R/W-0	R/W-0	R/W-0	R/W-0	R/W-0	R/W-0

Legend: R/W = Read/Write; -n = value after reset

Table B–186. Receive Format Unit Bit Mask Register (RMASK) Field Values

Bit	field [†]	symval [†]	Value	Description
31–0	RMASK[31–0]			Receive data mask enable bit.
		USEMASK	0	Corresponding bit of receive data (after passing through reverse and rotate units) is masked out and then padded with the selected bit pad value (RPAD and RPBIT bits in RFMT).
		NOMASK	1	Corresponding bit of receive data (after passing through reverse and rotate units) is returned to CPU or EDMA.

[†] For CSL implementation, use the notation MCASP_RMASK_RMASKn_symval

Table B–187. Receive Bit Stream Format Register (RFMT) Field Values (Continued)

Bit	field [†]	symval [†]	Value	Description
14–13	RPAD		0–3h	Pad value for extra bits in slot not belonging to the word. This field only applies to bits when RMASK[n] = 0.
		ZERO	0	Pad extra bits with 0.
		ONE	1h	Pad extra bits with 1.
		RPBIT	2h	Pad extra bits with one of the bits from the word as specified by RPBIT bits.
		–	3h	Reserved
12–8	RPBIT	OF(value)	0–1Fh	RPBIT value determines which bit (as read by the CPU or EDMA from RBUF[n]) is used to pad the extra bits. This field only applies when RPAD = 2h.
		DEFAULT	0	Pad with bit 0 value.
			1h–1Fh	Pad with bit 1 to bit 31 value.
7–4	RSSZ		0–Fh	Receive slot size.
		–	0–2h	Reserved
		8BITS	3h	Slot size is 8 bits.
		–	4h	Reserved
		12BITS	5h	Slot size is 12 bits.
		–	6h	Reserved
		16BITS	7h	Slot size is 16 bits.
		–	8h	Reserved
		20BITS	9h	Slot size is 20 bits.
		–	Ah	Reserved
		24BITS	Bh	Slot size is 24 bits.
		–	Ch	Reserved
		28BITS	Dh	Slot size is 28 bits.
		–	Eh	Reserved
32BITS	Fh	Slot size is 32 bits.		

[†] For CSL implementation, use the notation MCASP_RFMT_field_symval

Table B–187. Receive Bit Stream Format Register (RFMT) Field Values (Continued)

Bit	field [†]	symval [†]	Value	Description
3	RBUSEL			Selects whether reads from serializer buffer XRBUF[n] originate from the configuration bus (CFG) or the data (DAT) port.
		DAT	0	Reads from XRBUF[n] originate on data port. Reads from XRBUF[n] on configuration bus are ignored.
		CFG	1	Reads from XRBUF[n] originate on configuration bus. Reads from XRBUF[n] on data port are ignored.
2–0	RROT		0–7h	Right-rotation value for receive rotate right format unit.
		NONE	0	Rotate right by 0 (no rotation).
		4BITS	1h	Rotate right by 4 bit positions.
		8BITS	2h	Rotate right by 8 bit positions.
		12BITS	3h	Rotate right by 12 bit positions.
		16BITS	4h	Rotate right by 16 bit positions.
		20BITS	5h	Rotate right by 20 bit positions.
		24BITS	6h	Rotate right by 24 bit positions.
		28BITS	7h	Rotate right by 28 bit positions.

[†] For CSL implementation, use the notation MCASP_RFMT_field_symval

B.11.16 Receive Frame Sync Control Register (AFSRCTL)

The receive frame sync control register (AFSRCTL) configures the receive frame sync (AFSR). The AFSRCTL is shown in Figure B–178 and described in Table B–188.

Figure B–178. Receive Frame Sync Control Register (AFSRCTL)

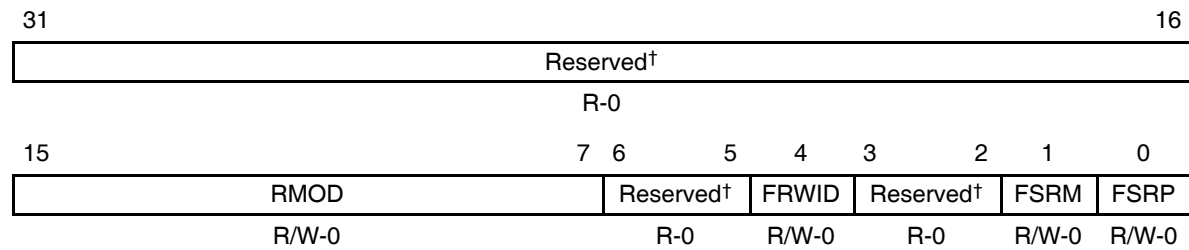

Legend: R = Read only; R/W = Read/Write; -n = value after reset

† If writing to this field, always write the default value for future device compatibility.

Table B–188. Receive Frame Sync Control Register (AFSRCTL) Field Values

Bit	field†	symval†	Value	Description
31–16	Reserved	–	0	value for future device compatibility.
15–7	RMOD	OF(value)	0–180h	Receive frame sync mode select bits.
		BURST	0	Burst mode
			1h	Reserved
			2h–20h	2-slot TDM (I2S mode) to 32-slot TDM
			21h–17Fh	Reserved
			180h	384-slot TDM (external DIR IC inputting 384-slot DIR frames to McASP over I2S interface)
6–5	Reserved	–	0	value for future device compatibility.
4	FRWID			Receive frame sync width select bit indicates the width of the receive frame sync (AFSR) during its active period.
		BIT	0	Single bit
		WORD	1	Single word
3–2	Reserved	–	0	value for future device compatibility.

† For CSL implementation, use the notation `MCASP_AFSRCTL_field_symval`

Table B–188. Receive Frame Sync Control Register (AFSRCTL) Field Values (Continued)

Bit	field [†]	symval [†]	Value	Description
1	FSRM			Receive frame sync generation select bit.
		EXTERNAL	0	Externally-generated receive frame sync
		INTERNAL	1	Internally-generated receive frame sync
0	FSRP			Receive frame sync polarity select bit.
		ACTIVEHIGH	0	A rising edge on receive frame sync (AFSR) indicates the beginning of a frame.
		ACTIVELOW	1	A falling edge on receive frame sync (AFSR) indicates the beginning of a frame.

[†] For CSL implementation, use the notation `MCASP_AFSRCTL_field_symval`

B.11.17 Receive Clock Control Register (ACLKRCTL)

The receive clock control register (ACLKRCTL) configures the receive bit clock (ACLKR) and the receive clock generator. The ACLKRCTL is shown in Figure B–179 and described in Table B–189.

Figure B–179. Receive Clock Control Register (ACLKRCTL)

31	8	7	6	5	4	0
Reserved [†]		CLKRP	Rsvd [†]	CLKRM	CLKRDIV	
R-0		R/W-0	R-0	R/W-1	R/W-0	

Legend: R = Read only; R/W = Read/Write; -n = value after reset

[†] If writing to this field, always write the default value for future device compatibility.

Table B–189. Receive Clock Control Register (ACLKRCTL) Field Values

Bit	field	symval [†]	Value	Description
31–8	Reserved	–	0	Reserved. The reserved bit location always returns the default value. A value written to this field has no effect. If writing to this field, always write the default value for future device compatibility.
7	CLKRP			Receive bitstream clock polarity select bit.
		FALLING	0	Falling edge. Receiver samples data on the falling edge of the serial clock, so the external transmitter driving this receiver must shift data out on the rising edge of the serial clock.
		RISING	1	Rising edge. Receiver samples data on the rising edge of the serial clock, so the external transmitter driving this receiver must shift data out on the falling edge of the serial clock.
6	Reserved	–	0	Reserved. The reserved bit location always returns the default value. A value written to this field has no effect. If writing to this field, always write the default value for future device compatibility.
5	CLKRM			Receive bit clock source bit.
		EXTERNAL	0	External receive clock source from ACLKR pin.
		INTERNAL	1	Internal receive clock source from output of programmable bit clock divider.
4–0	CLKRDIV	OF(<i>value</i>)	0–1Fh	Receive bit clock divide ratio bits determine the divide-down ratio from AHCLKR to ACLKR.
		DEFAULT	0	Divide-by-1
			1h	Divide-by-2
			2h–1Fh	Divide-by-3 to divide-by-32

[†] For CSL implementation, use the notation MCASP_ACLKRCTL_field_symval

B.11.18 Receive High-Frequency Clock Control Register (AHCLKRCTL)

The receive high-frequency clock control register (AHCLKRCTL) configures the receive high-frequency master clock (AHCLKR) and the receive clock generator. The AHCLKRCTL is shown in Figure B–180 and described in Table B–190.

Figure B–180. Receive High-Frequency Clock Control Register (AHCLKRCTL)

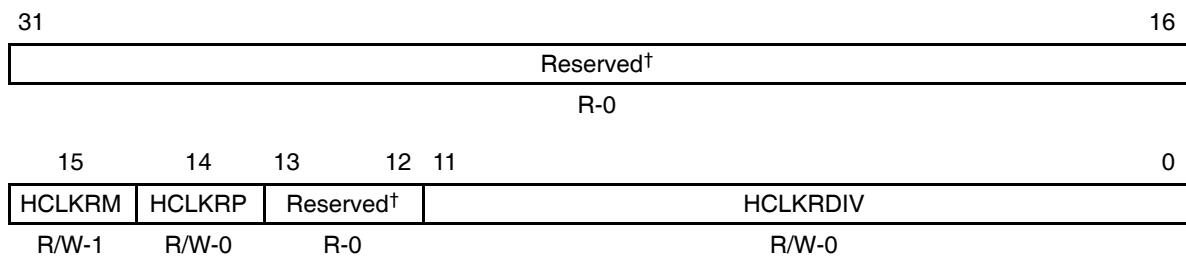

Legend: R = Read only; R/W = Read/Write; -n = value after reset

† If writing to this field, always write the default value for future device compatibility.

Table B–190. Receive High-Frequency Clock Control Register (AHCLKRCTL)
Field Values

Bit	field	symval†	Value	Description
31–16	Reserved	–	0	Reserved. The reserved bit location always returns the default value. A value written to this field has no effect. If writing to this field, always write the default value for future device compatibility.
15	HCLKRM			Receive high-frequency clock source bit.
		EXTERNAL	0	External receive high-frequency clock source from AHCLKR pin.
		INTERNAL	1	Internal receive high-frequency clock source from output of programmable high clock divider.

† For CSL implementation, use the notation MCASP_AHCLKRCTL_field_symval

Table B–190. Receive High-Frequency Clock Control Register (AHCLKRCTL)
Field Values (Continued)

Bit	field	symval [†]	Value	Description
14	HCLKRP	RISING	0	Rising edge. AHCLKR is not inverted before programmable bit clock divider. In the special case where the receive bit clock (ACLKR) is internally generated and the programmable bit clock divider is set to divide-by-1 (CLKRDIV = 0 in ACLKRCTL), AHCLKR is directly passed through to the ACLKR pin.
		FALLING	1	Falling edge. AHCLKR is inverted before programmable bit clock divider. In the special case where the receive bit clock (ACLKR) is internally generated and the programmable bit clock divider is set to divide-by-1 (CLKRDIV = 0 in ACLKRCTL), AHCLKR is directly passed through to the ACLKR pin.
13–12	Reserved	–	0	Reserved. The reserved bit location always returns the default value. A value written to this field has no effect. If writing to this field, always write the default value for future device compatibility.
11–0	HCLKRDIV	OF(value)	0–FFFh	Receive high-frequency clock divide ratio bits determine the divide-down ratio from AUXCLK to AHCLKR.
		DEFAULT	0	Divide-by-1
			1h	Divide-by-2
			2h–FFFh	Divide-by-3 to divide-by-4096

[†] For CSL implementation, use the notation MCASP_AHCLKRCTL_field_symval

B.11.19 Receive TDM Time Slot Register (RTDM)

The receive TDM time slot register (RTDM) specifies which TDM time slot the receiver is active. The RTDM is shown in Figure B–181 and described in Table B–191.

Figure B–181. Receive TDM Time Slot Register (RTDM)

31	30	29	28	27	26	25	24
RTDMS31	RTDMS30	RTDMS29	RTDMS28	RTDMS27	RTDMS26	RTDMS25	RTDMS24
R/W-0	R/W-0	R/W-0	R/W-0	R/W-0	R/W-0	R/W-0	R/W-0
23	22	21	20	19	18	17	16
RTDMS23	RTDMS22	RTDMS21	RTDMS20	RTDMS19	RTDMS18	RTDMS17	RTDMS16
R/W-0	R/W-0	R/W-0	R/W-0	R/W-0	R/W-0	R/W-0	R/W-0
15	14	13	12	11	10	9	8
RTDMS15	RTDMS14	RTDMS13	RTDMS12	RTDMS11	RTDMS10	RTDMS9	RTDMS8
R/W-0	R/W-0	R/W-0	R/W-0	R/W-0	R/W-0	R/W-0	R/W-0
7	6	5	4	3	2	1	0
RTDMS7	RTDMS6	RTDMS5	RTDMS4	RTDMS3	RTDMS2	RTDMS1	RTDMS0
R/W-0	R/W-0	R/W-0	R/W-0	R/W-0	R/W-0	R/W-0	R/W-0

Legend: R/W = Read/Write; -n = value after reset

Table B–191. Receive TDM Time Slot Register (RTDM) Field Values

Bit	field [†]	symval [†]	Value	Description
31–0	RTDMS[31–0]			Receiver mode during TDM time slot <i>n</i> .
		INACTIVE	0	Receive TDM time slot <i>n</i> is inactive. The receive serializer does not shift in data during this slot.
		ACTIVE	1	Receive TDM time slot <i>n</i> is active. The receive serializer shifts in data during this slot.

[†] For CSL implementation, use the notation MCASP_RTDM_RTDMSn_symval

B.11.20 Receiver Interrupt Control Register (RINTCTL)

The receiver interrupt control register (RINTCTL) controls generation of the McASP receive interrupt (RINT). When the register bit(s) is set to 1, the occurrence of the enabled McASP condition(s) generates RINT. The RINTCTL is shown in Figure B–182 and described in Table B–192. See section B.11.21 for a description of the interrupt conditions.

Figure B–182. Receiver Interrupt Control Register (RINTCTL)

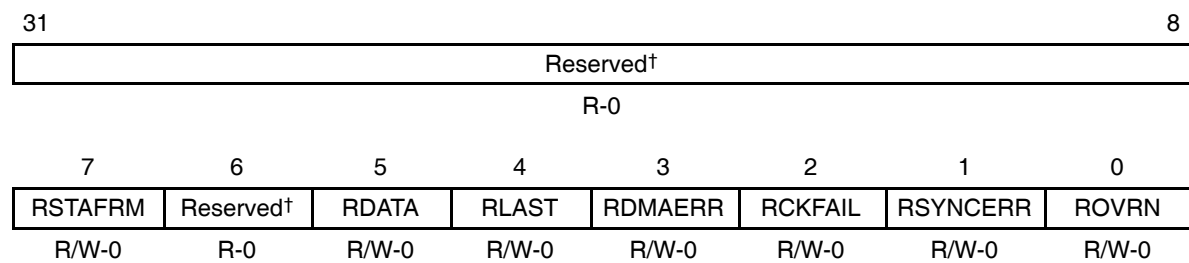

Legend: R = Read only; R/W = Read/Write; -n = value after reset

† If writing to this field, always write the default value for future device compatibility.

Table B–192. Receiver Interrupt Control Register (RINTCTL) Field Values

Bit	field†	symval†	Value	Description
31–8	Reserved	–	0	Reserved. The reserved bit location always returns the default value. A value written to this field has no effect. If writing to this field, always write the default value for future device compatibility.
7	RSTAFRM			Receive start of frame interrupt enable bit.
		DISABLE	0	Interrupt is disabled. A receive start of frame interrupt does not generate a McASP receive interrupt (RINT).
		ENABLE	1	Interrupt is enabled. A receive start of frame interrupt generates a McASP receive interrupt (RINT).
6	Reserved	–	0	Reserved. The reserved bit location always returns the default value. A value written to this field has no effect. If writing to this field, always write the default value for future device compatibility.

† For CSL implementation, use the notation `MCASP_RINTCTL_field_symval`

Table B–192. Receiver Interrupt Control Register (RINTCTL) Field Values (Continued)

Bit	field [†]	symval [†]	Value	Description
5	RDATA			Receive data ready interrupt enable bit.
		DISABLE	0	Interrupt is disabled. A receive data ready interrupt does not generate a McASP receive interrupt (RINT).
		ENABLE	1	Interrupt is enabled. A receive data ready interrupt generates a McASP receive interrupt (RINT).
4	RLAST			Receive last slot interrupt enable bit.
		DISABLE	0	Interrupt is disabled. A receive last slot interrupt does not generate a McASP receive interrupt (RINT).
		ENABLE	1	Interrupt is enabled. A receive last slot interrupt generates a McASP receive interrupt (RINT).
3	RDMAERR			Receive EDMA error interrupt enable bit.
		DISABLE	0	Interrupt is disabled. A receive EDMA error interrupt does not generate a McASP receive interrupt (RINT).
		ENABLE	1	Interrupt is enabled. A receive EDMA error interrupt generates a McASP receive interrupt (RINT).
2	RCKFAIL			Receive clock failure interrupt enable bit.
		DISABLE	0	Interrupt is disabled. A receive clock failure interrupt does not generate a McASP receive interrupt (RINT).
		ENABLE	1	Interrupt is enabled. A receive clock failure interrupt generates a McASP receive interrupt (RINT).
1	RSYNCERR			Unexpected receive frame sync interrupt enable bit.
		DISABLE	0	Interrupt is disabled. An unexpected receive frame sync interrupt does not generate a McASP receive interrupt (RINT).
		ENABLE	1	Interrupt is enabled. An unexpected receive frame sync interrupt generates a McASP receive interrupt (RINT).
0	ROVRN			Receiver overrun interrupt enable bit.
		DISABLE	0	Interrupt is disabled. A receiver overrun interrupt does not generate a McASP receive interrupt (RINT).
		ENABLE	1	Interrupt is enabled. A receiver overrun interrupt generates a McASP receive interrupt (RINT).

[†] For CSL implementation, use the notation `MCASP_RINTCTL_field_symval`

B.11.21 Receiver Status Register (RSTAT)

The receiver status register (RSTAT) provides the receiver status and receive TDM time slot number. If the McASP logic attempts to set an interrupt flag in the same cycle that the CPU writes to the flag to clear it, the McASP logic has priority and the flag remains set. This also causes a new interrupt request to be generated. The RSTAT is shown in Figure B–183 and described in Table B–193.

Figure B–183. Receiver Status Register (RSTAT)

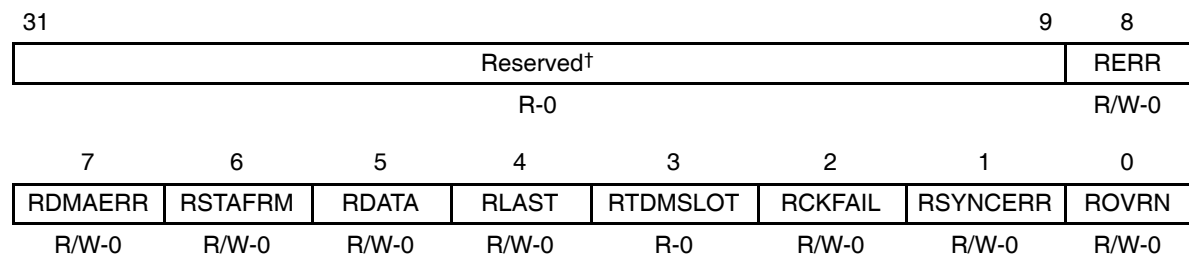

Legend: R = Read only; R/W = Read/Write; -n = value after reset
[†] If writing to this field, always write the default value for future device compatibility.

Table B–193. Receiver Status Register (RSTAT) Field Values

Bit	field [†]	symval [†]	Value	Description
31–9	Reserved	–	0	Reserved. The reserved bit location always returns the default value. A value written to this field has no effect. If writing to this field, always write the default value for future device compatibility.
8	RERR	OF(value)		RERR bit always returns a logic-OR of: ROVRN RSYNCERR RCKFAIL RDMAERR Allows a single bit to be checked to determine if a receiver error interrupt has occurred.
		DEFAULT	0	No errors have occurred.
			1	An error has occurred.

[†] For CSL implementation, use the notation MCASP_RSTAT_ *field_symval*

Table B–193. Receiver Status Register (RSTAT) Field Values (Continued)

Bit	field [†]	symval [†]	Value	Description
7	RDMAERR	OF(<i>value</i>)		Receive EDMA error flag. RDMAERR is set when the CPU or EDMA reads more serializers through the data port in a given time slot than were programmed as receivers. Causes a receive interrupt (RINT), if this bit is set and RDMAERR in RINTCTL is set. This bit is cleared by writing a 1 to this bit. Writing a 0 to this bit has no effect.
		DEFAULT	0	Receive EDMA error did not occur.
			1	Receive EDMA error did occur.
6	RSTAFRM			Receive start of frame flag. Causes a receive interrupt (RINT), if this bit is set and RSTAFRM in RINTCTL is set. This bit is cleared by writing a 1 to this bit. Writing a 0 to this bit has no effect.
		NO	0	No new receive frame sync (AFSR) is detected.
		YES	1	A new receive frame sync (AFSR) is detected.
5	RDATA			Receive data ready flag. Causes a receive interrupt (RINT), if this bit is set and RDATA in RINTCTL is set. This bit is cleared by writing a 1 to this bit. Writing a 0 to this bit has no effect.
		NO	0	No new data in RBUF.
		YES	1	Data is transferred from XRSR to RBUF and ready to be serviced by the CPU or EDMA. When RDATA is set, it always causes an EDMA event (AREVT).
4	RLAST			Receive last slot flag. RLAST is set along with RDATA, if the current slot is the last slot in a frame. Causes a receive interrupt (RINT), if this bit is set and RLAST in RINTCTL is set. This bit is cleared by writing a 1 to this bit. Writing a 0 to this bit has no effect.
		NO	0	Current slot is not the last slot in a frame.
		YES	1	Current slot is the last slot in a frame. RDATA is also set.
3	RTDMSLOT	OF(<i>value</i>)		Returns the LSB of RSLOT. Allows a single read of RSTAT to determine whether the current TDM time slot is even or odd.
		DEFAULT	0	Current TDM time slot is odd.
			1	Current TDM time slot is even.

[†] For CSL implementation, use the notation `MCASP_RSTAT_field_symval`

Table B–193. Receiver Status Register (RSTAT) Field Values (Continued)

Bit	field [†]	symval [†]	Value	Description
2	RCKFAIL			Receive clock failure flag. RCKFAIL is set when the receive clock failure detection circuit reports an error. Causes a receive interrupt (RINT), if this bit is set and RCKFAIL in RINTCTL is set. This bit is cleared by writing a 1 to this bit. Writing a 0 to this bit has no effect.
		NO	0	Receive clock failure did not occur.
		YES	1	Receive clock failure did occur.
1	RSYNCERR			Unexpected receive frame sync flag. RSYNCERR is set when a new receive frame sync (AFSR) occurs before it is expected. Causes a receive interrupt (RINT), if this bit is set and RSYNCERR in RINTCTL is set. This bit is cleared by writing a 1 to this bit. Writing a 0 to this bit has no effect.
		NO	0	Unexpected receive frame sync did not occur.
		YES	1	Unexpected receive frame sync did occur.
0	ROVRN			Receiver overrun flag. ROVRN is set when the receive serializer is instructed to transfer data from XRSR to RBUF, but the former data in RBUF has not yet been read by the CPU or EDMA. Causes a receive interrupt (RINT), if this bit is set and ROVRN in RINTCTL is set. This bit is cleared by writing a 1 to this bit. Writing a 0 to this bit has no effect.
		NO	0	Receiver overrun did not occur.
		YES	1	Receiver overrun did occur.

[†] For CSL implementation, use the notation MCASP_RSTAT_*field_symval*

B.11.22 Current Receive TDM Time Slot Registers (RSLOT)

The current receive TDM time slot register (RSLOT) indicates the current time slot for the receive data frame. The RSLOT is shown in Figure B–184 and described in Table B–194.

Figure B–184. Current Receive TDM Time Slot Register (RSLOT)

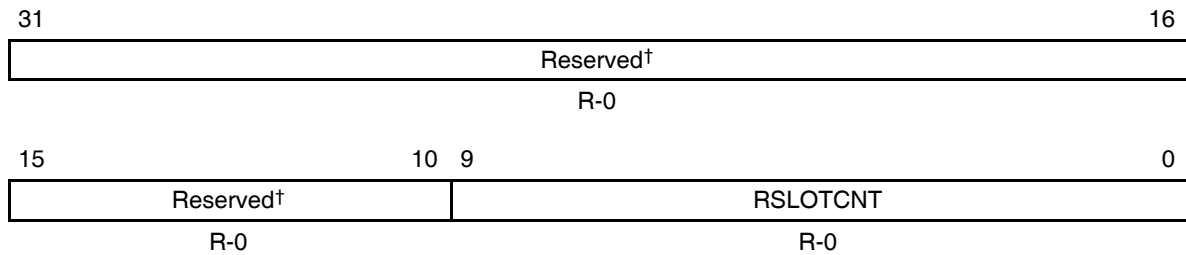

Legend: R = Read only; -n = value after reset

† If writing to this field, always write the default value for future device compatibility.

Table B–194. Current Receive TDM Time Slot Register (RSLOT) Field Values

Bit	Field	symval†	Value	Description
31–10	Reserved	–	0	Reserved. The reserved bit location always returns the default value. A value written to this field has no effect. If writing to this field, always write the default value for future device compatibility.
9–0	RSLOTCNT	OF(value)	0–17Fh	Current receive time slot count. Legal values: 0 to 383. TDM function is not supported for > 32 time slots. However, TDM time slot counter may count to 383 when used to receive a DIR block (transferred over TDM format).

† For CSL implementation, use the notation MCASP_RSLOT_RSLOTCNT_symval

B.11.23 Receive Clock Check Control Register (RCLKCHK)

The receive clock check control register (RCLKCHK) configures the receive clock failure detection circuit. The RCLKCHK is shown in Figure B–185 and described in Table B–195.

Figure B–185. Receive Clock Check Control Register (RCLKCHK)

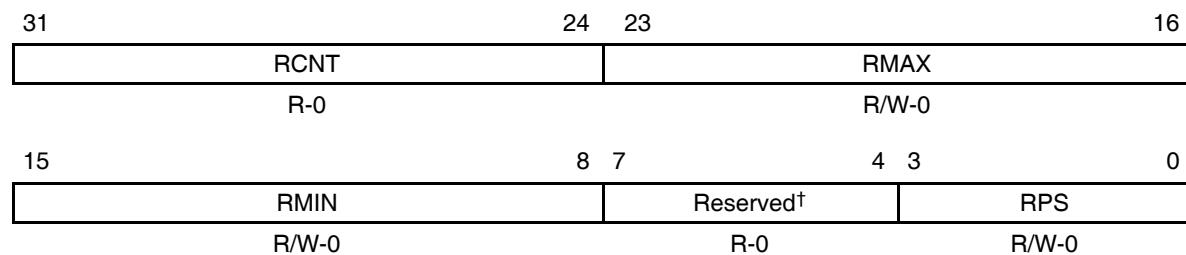

Legend: R = Read only; R/W = Read/Write; -n = value after reset

[†] If writing to this field, always write the default value for future device compatibility.

Table B–195. Receive Clock Check Control Register (RCLKCHK) Field Values

Bit	field [†]	symval [†]	Value	Description
31–24	RCNT	OF(value)	0–FFh	Receive clock count value (from previous measurement). The clock circuit continually counts the number of DSP system clocks for every 32 receive high-frequency master clock (AHCLKR) signals, and stores the count in RCNT until the next measurement is taken.
23–16	RMAX	OF(value)	0–FFh	Receive clock maximum boundary. This 8-bit unsigned value sets the maximum allowed boundary for the clock check counter after 32 receive high-frequency master clock (AHCLKR) signals have been received. If the current counter value is greater than RMAX after counting 32 AHCLKR signals, RCKFAIL in RSTAT is set. The comparison is performed using unsigned arithmetic.
15–8	RMIN	OF(value)	0–FFh	Receive clock minimum boundary. This 8-bit unsigned value sets the minimum allowed boundary for the clock check counter after 32 receive high-frequency master clock (AHCLKR) signals have been received. If RCNT is less than RMIN after counting 32 AHCLKR signals, RCKFAIL in RSTAT is set. The comparison is performed using unsigned arithmetic.

[†] For CSL implementation, use the notation MCASP_RCLKCHK_field_symval

Table B–195. Receive Clock Check Control Register (RCLKCHK) Field Values (Continued)

Bit	field [†]	symval [†]	Value	Description
7–4	Reserved	–	0	Reserved. The reserved bit location always returns the default value. A value written to this field has no effect. If writing to this field, always write the default value for future device compatibility.
3–0	RPS		0–Fh	Receive clock check prescaler value.
		DIVBY1	0	McASP system clock divided by 1
		DIVBY2	1h	McASP system clock divided by 2
		DIVBY4	2h	McASP system clock divided by 4
		DIVBY8	3h	McASP system clock divided by 8
		DIVBY16	4h	McASP system clock divided by 16
		DIVBY32	5h	McASP system clock divided by 32
		DIVBY64	6h	McASP system clock divided by 64
		DIVBY128	7h	McASP system clock divided by 128
		DIVBY256	8h	McASP system clock divided by 256
		–	9h–Fh	Reserved

[†] For CSL implementation, use the notation `MCASP_RCLKCHK_field_symval`

B.11.24 Receiver DMA Event Control Register (REVTCTL)

The receiver DMA event control register (REVTCTL) contains a disable bit for the receiver DMA event. The REVTCTL is shown in Figure B–186 and described in Table B–196.

DSP specific registers

Accessing REVTCTL not implemented on a specific DSP may cause improper device operation.

Figure B–186. Receiver DMA Event Control Register (REVTCTL)

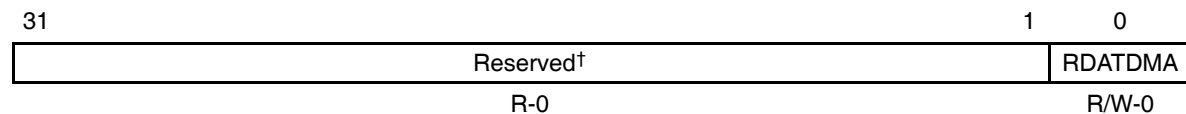

Legend: R = Read only; R/W = Read/Write; -n = value after reset
 † If writing to this field, always write the default value for future device compatibility.

Table B–196. Receiver DMA Event Control Register (REVTCTL) Field Values

Bit	field	symval†	Value	Description
31–1	Reserved	–	0	Reserved. The reserved bit location always returns the default value. A value written to this field has no effect. If writing to this field, always write the default value for future device compatibility.
0	RDATDMA			Receive data DMA request enable bit.
		ENABLE	0	Receive data DMA request is enabled.
		DISABLE	1	Receive data DMA request is disabled.

† For CSL implementation, use the notation MCASP_REVTCTL_RDATDMA_symval

B.11.25 Transmitter Global Control Register (XGBLCTL)

Alias of the global control register (GBLCTL). Writing to the transmitter global control register (XGBLCTL) affects only the transmit bits of GBLCTL (bits 12–8). Reads from XGBLCTL return the value of GBLCTL. XGBLCTL allows the transmitter to be reset independently from the receiver. The XGBLCTL is shown in Figure B–187 and described in Table B–197. See section B.11.9 for a detailed description of GBLCTL.

Figure B–187. Transmitter Global Control Register (XGBLCTL)

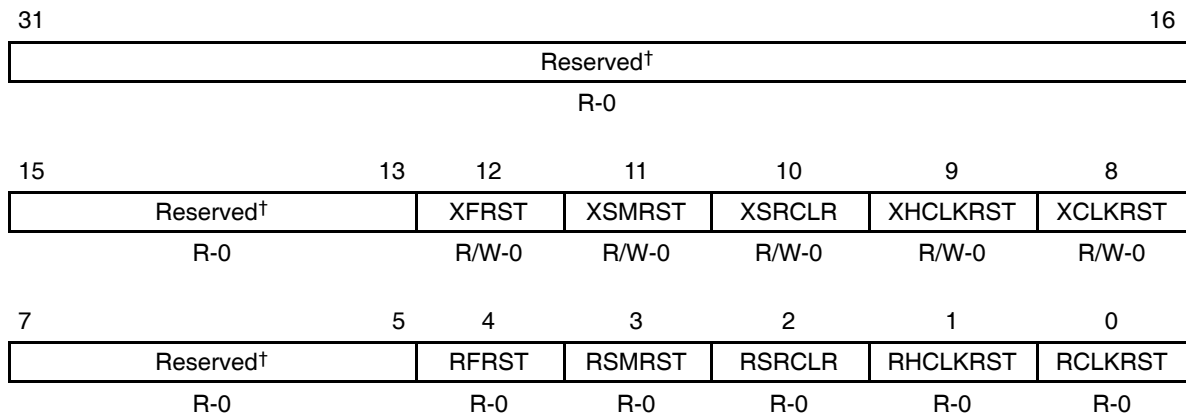

Legend: R = Read only; R/W = Read/Write; -n = value after reset

† If writing to this field, always write the default value for future device compatibility.

Table B–197. Transmitter Global Control Register (XGBLCTL) Field Values

Bit	field†	symval†	Value	Description
31–13	Reserved	–	0	Reserved. The reserved bit location always returns the default value. A value written to this field has no effect. If writing to this field, always write the default value for future device compatibility.
12	XFRST			Transmit frame sync generator reset enable bit. A write to this bit affects the XFRST bit of GBLCTL.
		RESET	0	Transmit frame sync generator is reset.
		ACTIVE	1	Transmit frame sync generator is active.

† For CSL implementation, use the notation `MCASP_XGBLCTL_field_symval`

Table B–197. Transmitter Global Control Register (XGBLCTL) Field Values (Continued)

Bit	field [†]	symval [†]	Value	Description
11	XSMRST			Transmit state machine reset enable bit. A write to this bit affects the XSMRST bit of GBLCTL.
		RESET	0	Transmit state machine is held in reset.
		ACTIVE	1	Transmit state machine is released from reset.
10	XSRCLR			Transmit serializer clear enable bit. A write to this bit affects the XSRCLR bit of GBLCTL.
		CLEAR	0	Transmit serializers are cleared.
		ACTIVE	1	Transmit serializers are active.
9	XHCLKRST			Transmit high-frequency clock divider reset enable bit. A write to this bit affects the XHCLKRST bit of GBLCTL.
		RESET	0	Transmit high-frequency clock divider is held in reset.
		ACTIVE	1	Transmit high-frequency clock divider is running.
8	XCLKRST			Transmit clock divider reset enable bit. A write to this bit affects the XCLKRST bit of GBLCTL.
		RESET	0	Transmit clock divider is held in reset.
		ACTIVE	1	Transmit clock divider is running.
7–5	Reserved	–	0	Reserved. The reserved bit location always returns the default value. A value written to this field has no effect. If writing to this field, always write the default value for future device compatibility.
4	RFRST	–	x	Receive frame sync generator reset enable bit. A read of this bit returns the RFRST bit value of GBLCTL. Writes have no effect.
3	RSMRST	–	x	Receive state machine reset enable bit. A read of this bit returns the RSMRST bit value of GBLCTL. Writes have no effect.
2	RSRCLR	–	x	Receive serializer clear enable bit. A read of this bit returns the RSRCLR bit value of GBLCTL. Writes have no effect.

[†] For CSL implementation, use the notation MCASP_XGBLCTL_field_symval

Table B–197. Transmitter Global Control Register (XGBLCTL) Field Values (Continued)

Bit	field [†]	symval [†]	Value	Description
1	RHCLKRST	–	x	Receive high-frequency clock divider reset enable bit. A read of this bit returns the RHCLKRST bit value of GBLCTL. Writes have no effect.
0	RCLKRST	–	x	Receive clock divider reset enable bit. A read of this bit returns the RCLKRST bit value of GBLCTL. Writes have no effect.

[†] For CSL implementation, use the notation `MCASP_XGBLCTL_field_symval`

B.11.26 Transmit Format Unit Bit Mask Register (XMASK)

The transmit format unit bit mask register (XMASK) determines which bits of the transmitted data are masked off and padded with a known value before being shifted out the McASP. The XMASK is shown in Figure B–188 and described in Table B–198.

Figure B–188. Transmit Format Unit Bit Mask Register (XMASK)

31	30	29	28	27	26	25	24
XMASK31	XMASK30	XMASK29	XMASK28	XMASK27	XMASK26	XMASK25	XMASK24
R/W-0	R/W-0	R/W-0	R/W-0	R/W-0	R/W-0	R/W-0	R/W-0
23	22	21	20	19	18	17	16
XMASK23	XMASK22	XMASK21	XMASK20	XMASK19	XMASK18	XMASK17	XMASK16
R/W-0	R/W-0	R/W-0	R/W-0	R/W-0	R/W-0	R/W-0	R/W-0
15	14	13	12	11	10	9	8
XMASK15	XMASK14	XMASK13	XMASK12	XMASK11	XMASK10	XMASK9	XMASK8
R/W-0	R/W-0	R/W-0	R/W-0	R/W-0	R/W-0	R/W-0	R/W-0
7	6	5	4	3	2	1	0
XMASK7	XMASK6	XMASK5	XMASK4	XMASK3	XMASK2	XMASK1	XMASK0
R/W-0	R/W-0	R/W-0	R/W-0	R/W-0	R/W-0	R/W-0	R/W-0

Legend: R/W = Read/Write; -n = value after reset

Table B–198. Transmit Format Unit Bit Mask Register (XMASK) Field Values

Bit	field [†]	symval [†]	Value	Description
31–0	XMASK[31–0]			Transmit data mask enable bit.
		USEMASK	0	Corresponding bit of transmit data (before passing through reverse and rotate units) is masked out and then padded with the selected bit pad value (XPAD and XPBIT bits in XFMT), which is transmitted out the McASP in place of the original bit.
		NOMASK	1	Corresponding bit of transmit data (before passing through reverse and rotate units) is transmitted out the McASP.

[†] For CSL implementation, use the notation MCASP_XMASK_XMASKn_symval

B.11.27 Transmit Bit Stream Format Register (XFMT)

The transmit bit stream format register (XFMT) configures the transmit data format. The XFMT is shown in Figure B–189 and described in Table B–199.

Figure B–189. Transmit Bit Stream Format Register (XFMT)

31															18		17	16		
Reserved†															XDATDLY					
R-0															R/W-0					
15			14		13		12		8		7	4		3	2	0				
XRVRS		XPAD		XPBIT		XSSZ		XBUSEL		XROT										
R/W-0		R/W-0		R/W-0		R/W-0		R/W-0		R/W-0		R/W-0		R/W-0						

Legend: R = Read only; R/W = Read/Write; -n = value after reset

† If writing to this field, always write the default value for future device compatibility.

Table B–199. Transmit Bit Stream Format Register (XFMT) Field Values

Bit	field†	symval†	Value	Description
31–18	Reserved	–	0	Reserved. The reserved bit location always returns the default value. A value written to this field has no effect. If writing to this field, always write the default value for future device compatibility.
17–16	XDATDLY		0–3h	Transmit sync bit delay.
		0BIT	0	0-bit delay. The first transmit data bit, AXR[n], occurs in the same ACLKX cycle as the transmit frame sync (AFSX).
		1BIT	1h	1-bit delay. The first transmit data bit, AXR[n], occurs one ACLKX cycle after the transmit frame sync (AFSX).
		2BIT	2h	2-bit delay. The first transmit data bit, AXR[n], occurs two ACLKX cycles after the transmit frame sync (AFSX).
		–	3h	Reserved
15	XRVRS			Transmit serial bitstream order.
		LSBFIRST	0	Bitstream is LSB first. No bit reversal is performed in transmit format bit reverse unit.
		MSBFIRST	1	Bitstream is MSB first. Bit reversal is performed in transmit format bit reverse unit.

† For CSL implementation, use the notation MCASP_XFMT_field_symval

Table B–199. Transmit Bit Stream Format Register (XFMT) Field Values (Continued)

Bit	field [†]	symval [†]	Value	Description
14–13	XPAD		0–3h	Pad value for extra bits in slot not belonging to word defined by XMASK. This field only applies to bits when XMASK[n] = 0.
		ZERO	0	Pad extra bits with 0.
		ONE	1h	Pad extra bits with 1.
		XPBIT	2h	Pad extra bits with one of the bits from the word as specified by XPBIT bits.
		–	3h	Reserved
12–8	XPBIT	OF(value)	0–1Fh	XPBIT value determines which bit (as written by the CPU or EDMA to XBUF[n]) is used to pad the extra bits before shifting. This field only applies when XPAD = 2h.
		DEFAULT	0	Pad with bit 0 value.
			1h–1Fh	Pad with bit 1 to bit 31 value.
7–4	XSSZ		0–Fh	Transmit slot size.
		–	0–2h	Reserved
		8BITS	3h	Slot size is 8 bits.
		–	4h	Reserved
		12BITS	5h	Slot size is 12 bits.
		–	6h	Reserved
		16BITS	7h	Slot size is 16 bits.
		–	8h	Reserved
		20BITS	9h	Slot size is 20 bits.
		–	Ah	Reserved
		24BITS	Bh	Slot size is 24 bits.
		–	Ch	Reserved
		28BITS	Dh	Slot size is 28 bits.
		–	Eh	Reserved
		32BITS	Fh	Slot size is 32 bits.

[†] For CSL implementation, use the notation MCASP_XFMT_field_symval

Table B–199. Transmit Bit Stream Format Register (XFMT) Field Values (Continued)

Bit	field [†]	symval [†]	Value	Description
3	XBUSEL			Selects whether writes to serializer buffer XRBUF[n] originate from the configuration bus (CFG) or the data (DAT) port.
		DAT	0	Writes to XRBUF[n] originate from the data port. Writes to XRBUF[n] from the configuration bus are ignored with no effect to the McASP.
		CFG	1	Writes to XRBUF[n] originate from the configuration bus. Writes to XRBUF[n] from the data port are ignored with no effect to the McASP.
2–0	XROT		0–7h	Right-rotation value for transmit rotate right format unit.
		NONE	0	Rotate right by 0 (no rotation).
		4BITS	1h	Rotate right by 4 bit positions.
		8BITS	2h	Rotate right by 8 bit positions.
		12BITS	3h	Rotate right by 12 bit positions.
		16BITS	4h	Rotate right by 16 bit positions.
		20BITS	5h	Rotate right by 20 bit positions.
		24BITS	6h	Rotate right by 24 bit positions.
28BITS	7h	Rotate right by 28 bit positions.		

[†] For CSL implementation, use the notation `MCASP_XFMT_field_symval`

B.11.28 Transmit Frame Sync Control Register (AFSXCTL)

The transmit frame sync control register (AFSXCTL) configures the transmit frame sync (AFSX). The AFSXCTL is shown in Figure B–190 and described in Table B–200.

Figure B–190. Transmit Frame Sync Control Register (AFSXCTL)

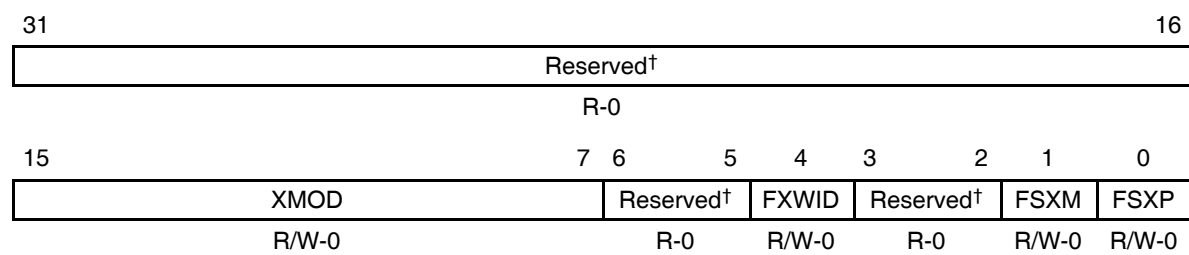

Legend: R = Read only; R/W = Read/Write; -n = value after reset

† If writing to this field, always write the default value for future device compatibility.

Table B–200. Transmit Frame Sync Control Register (AFSXCTL) Field Values

Bit	field†	symval†	Value	Description
31–16	Reserved	–	0	Reserved. The reserved bit location always returns the default value. A value written to this field has no effect. If writing to this field, always write the default value for future device compatibility.
15–7	XMOD	OF(value)	0–180h	Transmit frame sync mode select bits.
		BURST	0	Burst mode
			1h	Reserved
			2h–20h	2-slot TDM (I2S mode) to 32-slot TDM
			21h–17Fh	Reserved
			180h	384-slot DIT mode
6–5	Reserved	–	0	Reserved. The reserved bit location always returns the default value. A value written to this field has no effect. If writing to this field, always write the default value for future device compatibility.

† For CSL implementation, use the notation `MCASP_AFSXCTL_field_symval`

Table B–200. Transmit Frame Sync Control Register (AFSXCTL) Field Values

Bit	field [†]	symval [†]	Value	Description
4	FXWID			Transmit frame sync width select bit indicates the width of the transmit frame sync (AFSX) during its active period.
		BIT	0	Single bit
		WORD	1	Single word
3–2	Reserved	–	0	Reserved. The reserved bit location always returns the default value. A value written to this field has no effect. If writing to this field, always write the default value for future device compatibility.
1	FSXM			Transmit frame sync generation select bit.
		EXTERNAL	0	Externally-generated transmit frame sync
		INTERNAL	1	Internally-generated transmit frame sync
0	FSXP			Transmit frame sync polarity select bit.
		ACTIVEHIGH	0	A rising edge on transmit frame sync (AFSX) indicates the beginning of a frame.
		ACTIVELOW	1	A falling edge on transmit frame sync (AFSX) indicates the beginning of a frame.

[†] For CSL implementation, use the notation `MCASP_AFSXCTL_field_symval`

B.11.29 Transmit Clock Control Register (ACLKXCTL)

The transmit clock control register (ACLKXCTL) configures the transmit bit clock (ACLKX) and the transmit clock generator. The ACLKXCTL is shown in Figure B–191 and described in Table B–201.

Figure B–191. Transmit Clock Control Register (ACLKXCTL)

31	8	7	6	5	4	0
Reserved [†]		CLKXP	ASYNC	CLKXM	CLKXDIV	
R-0		R/W-0	R/W-1	R/W-1	R/W-0	

Legend: R = Read only; R/W = Read/Write; -n = value after reset

[†] If writing to this field, always write the default value for future device compatibility.

Table B–201. Transmit Clock Control Register (ACLKXCTL) Field Values

Bit	field	symval [†]	Value	Description
31–8	Reserved	–	0	Reserved. The reserved bit location always returns the default value. A value written to this field has no effect. If writing to this field, always write the default value for future device compatibility.
7	CLKXP			Transmit bitstream clock polarity select bit.
		RISING	0	Rising edge. External receiver samples data on the falling edge of the serial clock, so the transmitter must shift data out on the rising edge of the serial clock.
		FALLING	1	Falling edge. External receiver samples data on the rising edge of the serial clock, so the transmitter must shift data out on the falling edge of the serial clock.
6	ASYNC			Transmit/receive operation asynchronous enable bit.
		SYNC	0	Synchronous. Transmit clock and frame sync provides the source for both the transmit and receive sections.
		ASYNC	1	Asynchronous. Separate clock and frame sync used by transmit and receive sections.
5	CLKXM			Transmit bit clock source bit.
		EXTERNAL	0	External transmit clock source from ACLKX pin.
		INTERNAL	1	Internal transmit clock source from output of programmable bit clock divider.
4–0	CLKXDIV	OF(value)	0–1Fh	Transmit bit clock divide ratio bits determine the divide-down ratio from AHCLKX to ACLKX.
		DEFAULT	0	Divide-by-1
			1h	Divide-by-2
			2h–1Fh	Divide-by-3 to divide-by-32

[†] For CSL implementation, use the notation MCASP_ACLKXCTL_field_symval

B.11.30 Transmit High-Frequency Clock Control Register (AHCLKXCTL)

The transmit high-frequency clock control register (AHCLKXCTL) configures the transmit high-frequency master clock (AHCLKX) and the transmit clock generator. The AHCLKXCTL is shown in Figure B–192 and described in Table B–202.

Figure B–192. Transmit High Frequency Clock Control Register (AHCLKXCTL)

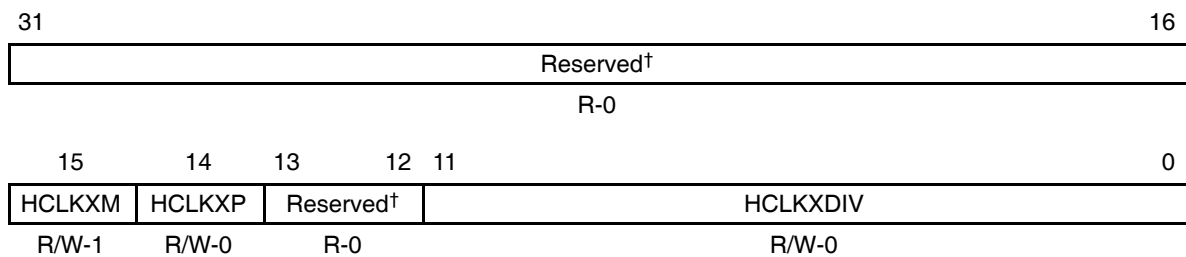

Legend: R = Read only; R/W = Read/Write; -n = value after reset

† If writing to this field, always write the default value for future device compatibility.

Table B–202. Transmit High-Frequency Clock Control Register (AHCLKXCTL) Field Values

Bit	field	symval†	Value	Description
31–16	Reserved	–	0	Reserved. The reserved bit location always returns the default value. A value written to this field has no effect. If writing to this field, always write the default value for future device compatibility.
15	HCLKXM			Transmit high-frequency clock source bit.
		EXTERNAL	0	External transmit high-frequency clock source from AHCLKX pin.
		INTERNAL	1	Internal transmit high-frequency clock source from output of programmable high clock divider.

† For CSL implementation, use the notation MCASP_AHCLKXCTL_field_symval

**Table B–202. Transmit High-Frequency Clock Control Register (AHCLKXCTL)
Field Values (Continued)**

Bit	field	symval [†]	Value	Description
14	HCLKXP	RISING	0	Rising edge. AHCLKX is not inverted before programmable bit clock divider. In the special case where the transmit bit clock (ACLKX) is internally generated and the programmable bit clock divider is set to divide-by-1 (CLKXDIV = 0 in ACLKXCTL), AHCLKX is directly passed through to the ACLKX pin.
		FALLING	1	Falling edge. AHCLKX is inverted before programmable bit clock divider. In the special case where the transmit bit clock (ACLKX) is internally generated and the programmable bit clock divider is set to divide-by-1 (CLKXDIV = 0 in ACLKXCTL), AHCLKX is directly passed through to the ACLKX pin.
13–12	Reserved	–	0	Reserved. The reserved bit location always returns the default value. A value written to this field has no effect. If writing to this field, always write the default value for future device compatibility.
11–0	HCLKXDIV	OF(value)	0–FFFh	Transmit high-frequency clock divide ratio bits determine the divide-down ratio from AUXCLK to AHCLKX.
		DEFAULT	0	Divide-by-1
			1h	Divide-by-2
			2h–FFFh	Divide-by-3 to divide-by-4096

[†] For CSL implementation, use the notation `MCASP_AHCLKXCTL_field_symval`

B.11.31 Transmit TDM Time Slot Register (XTDM)

The transmit TDM time slot register (XTDM) specifies in which TDM time slot the transmitter is active. TDM time slot counter range is extended to 384 slots (to support SPDIF blocks of 384 subframes). XTDM operates modulo 32, that is, XTDM specifies the TDM activity for time slots 0, 32, 64, 96, 128, etc. The XTDM is shown in Figure B–193 and described in Table B–203.

Figure B–193. Transmit TDM Time Slot Register (XTDM)

31	30	29	28	27	26	25	24
XTDMS31	XTDMS30	XTDMS29	XTDMS28	XTDMS27	XTDMS26	XTDMS25	XTDMS24
R/W-0	R/W-0	R/W-0	R/W-0	R/W-0	R/W-0	R/W-0	R/W-0
23	22	21	20	19	18	17	16
XTDMS23	XTDMS22	XTDMS21	XTDMS20	XTDMS19	XTDMS18	XTDMS17	XTDMS16
R/W-0	R/W-0	R/W-0	R/W-0	R/W-0	R/W-0	R/W-0	R/W-0
15	14	13	12	11	10	9	8
XTDMS15	XTDMS14	XTDMS13	XTDMS12	XTDMS11	XTDMS10	XTDMS9	XTDMS8
R/W-0	R/W-0	R/W-0	R/W-0	R/W-0	R/W-0	R/W-0	R/W-0
7	6	5	4	3	2	1	0
XTDMS7	XTDMS6	XTDMS5	XTDMS4	XTDMS3	XTDMS2	XTDMS1	XTDMS0
R/W-0	R/W-0	R/W-0	R/W-0	R/W-0	R/W-0	R/W-0	R/W-0

Legend: R/W = Read/Write; -n = value after reset

Table B–203. Transmit TDM Time Slot Register (XTDM) Field Values

Bit	field [†]	symval [†]	Value	Description
31–0	XTDMS[31–0]			Transmitter mode during TDM time slot <i>n</i> .
		INACTIVE	0	Transmit TDM time slot <i>n</i> is inactive. The transmit serializer does not shift out data during this slot.
		ACTIVE	1	Transmit TDM time slot <i>n</i> is active. The transmit serializer shifts out data during this slot according to the serializer control register (SRCTL).

[†] For CSL implementation, use the notation MCASP_XTDM_XTDMSn_symval

B.11.32 Transmitter Interrupt Control Register (XINTCTL)

The transmitter interrupt control register (XINTCTL) controls generation of the McASP transmit interrupt (XINT). When the register bit(s) is set to 1, the occurrence of the enabled McASP condition(s) generates XINT. The XINTCTL is shown in Figure B–194 and described in Table B–204. See section B.11.33 for a description of the interrupt conditions.

Figure B–194. Transmitter Interrupt Control Register (XINTCTL)

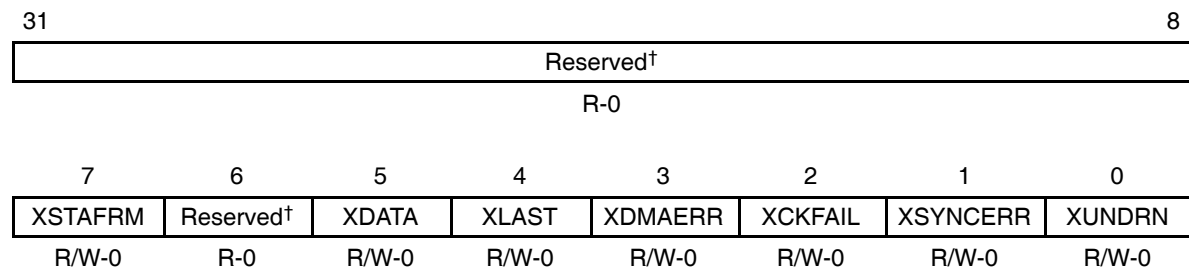

Legend: R = Read only; R/W = Read/Write; -n = value after reset
 † If writing to this field, always write the default value for future device compatibility.

Table B–204. Transmitter Interrupt Control Register (XINTCTL) Field Values

Bit	field†	symval†	Value	Description
31–8	Reserved	–	0	Reserved. The reserved bit location always returns the default value. A value written to this field has no effect. If writing to this field, always write the default value for future device compatibility.
7	XSTAFRM	DISABLE	0	Interrupt is disabled. A transmit start of frame interrupt does not generate a McASP transmit interrupt (XINT).
		ENABLE	1	Interrupt is enabled. A transmit start of frame interrupt generates a McASP transmit interrupt (XINT).
6	Reserved	–	0	Reserved. The reserved bit location always returns the default value. A value written to this field has no effect. If writing to this field, always write the default value for future device compatibility.

† For CSL implementation, use the notation `MCASP_XINTCTL_field_symval`

Table B–204. Transmitter Interrupt Control Register (XINTCTL) Field Values (Continued)

Bit	field [†]	symval [†]	Value	Description
5	XDATA			Transmit data ready interrupt enable bit.
		DISABLE	0	Interrupt is disabled. A transmit data ready interrupt does not generate a McASP transmit interrupt (XINT).
		ENABLE	1	Interrupt is enabled. A transmit data ready interrupt generates a McASP transmit interrupt (XINT).
4	XLAST			Transmit last slot interrupt enable bit.
		DISABLE	0	Interrupt is disabled. A transmit last slot interrupt does not generate a McASP transmit interrupt (XINT).
		ENABLE	1	Interrupt is enabled. A transmit last slot interrupt generates a McASP transmit interrupt (XINT).
3	XDMAERR			Transmit EDMA error interrupt enable bit.
		DISABLE	0	Interrupt is disabled. A transmit EDMA error interrupt does not generate a McASP transmit interrupt (XINT).
		ENABLE	1	Interrupt is enabled. A transmit EDMA error interrupt generates a McASP transmit interrupt (XINT).
2	XCKFAIL			Transmit clock failure interrupt enable bit.
		DISABLE	0	Interrupt is disabled. A transmit clock failure interrupt does not generate a McASP transmit interrupt (XINT).
		ENABLE	1	Interrupt is enabled. A transmit clock failure interrupt generates a McASP transmit interrupt (XINT).
1	XSYNCERR			Unexpected transmit frame sync interrupt enable bit.
		DISABLE	0	Interrupt is disabled. An unexpected transmit frame sync interrupt does not generate a McASP transmit interrupt (XINT).
		ENABLE	1	Interrupt is enabled. An unexpected transmit frame sync interrupt generates a McASP transmit interrupt (XINT).

[†] For CSL implementation, use the notation `MCASP_XINTCTL_field_symval`

Table B–204. Transmitter Interrupt Control Register (XINTCTL) Field Values (Continued)

Bit	field [†]	symval [†]	Value	Description
0	XUNDRN			Transmitter underrun interrupt enable bit.
		DISABLE	0	Interrupt is disabled. Interrupt is disabled. A transmitter underrun interrupt does not generate a McASP transmit interrupt (XINT).
		ENABLE	1	Interrupt is enabled. A transmitter underrun interrupt generates a McASP transmit interrupt (XINT).

[†] For CSL implementation, use the notation MCASP_XINTCTL_field_symval

B.11.33 Transmitter Status Register (XSTAT)

The transmitter status register (XSTAT) provides the transmitter status and transmit TDM time slot number. If the McASP logic attempts to set an interrupt flag in the same cycle that the CPU writes to the flag to clear it, the McASP logic has priority and the flag remains set. This also causes a new interrupt request to be generated. The XSTAT is shown in Figure B–195 and described in Table B–205.

Figure B–195. Transmitter Status Register (XSTAT)

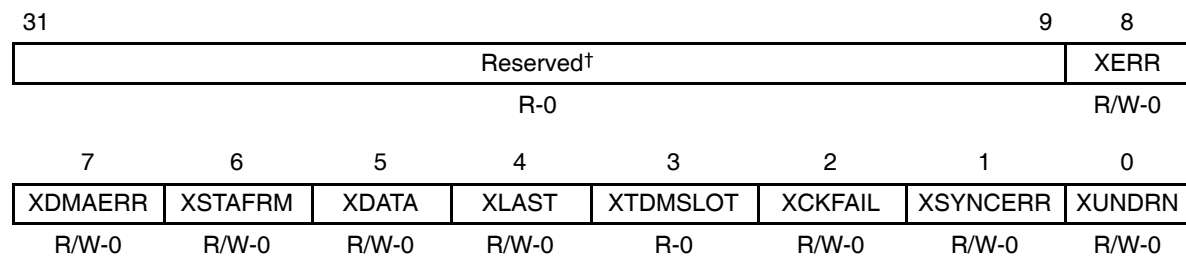

Legend: R = Read only; R/W = Read/Write; -n = value after reset

[†] If writing to this field, always write the default value for future device compatibility.

Table B–205. Transmitter Status Register (XSTAT) Field Values

Bit	field [†]	symval [†]	Value	Description	
31–9	Reserved	–	0	Reserved. The reserved bit location always returns the default value. A value written to this field has no effect. If writing to this field, always write the default value for future device compatibility.	
8	XERR	OF(<i>value</i>)		XERR bit always returns a logic-OR of: XUNDRN XSYNCERR XCKFAIL XDMAERR Allows a single bit to be checked to determine if a transmitter error interrupt has occurred.	
			DEFAULT	0	No errors have occurred.
			1	An error has occurred.	
7	XDMAERR	OF(<i>value</i>)		Transmit EDMA error flag. XDMAERR is set when the CPU or EDMA writes more serializers through the data port in a given time slot than were programmed as transmitters. Causes a transmit interrupt (XINT), if this bit is set and XDMAERR in XINTCTL is set. This bit is cleared by writing a 1 to this bit. Writing a 0 has no effect.	
			DEFAULT	0	Transmit EDMA error did not occur.
			1	Transmit EDMA error did occur.	
6	XSTAFRM			Transmit start of frame flag. Causes a transmit interrupt (XINT), if this bit is set and XSTAFRM in XINTCTL is set. This bit is cleared by writing a 1 to this bit. Writing a 0 has no effect.	
			NO	0	No new transmit frame sync (AFSX) is detected.
			YES	1	A new transmit frame sync (AFSX) is detected.
5	XDATA			Transmit data ready flag. Causes a transmit interrupt (XINT), if this bit is set and XDATA in XINTCTL is set. This bit is cleared by writing a 1 to this bit. Writing a 0 has no effect.	
			NO	0	XBUF is written and is full.
			YES	1	Data is copied from XBUF to XRSR. XBUF is empty and ready to be written. XDATA is also set when the transmit serializers are taken out of reset. When XDATA is set, it always causes an EDMA event (AXEVT).

[†] For CSL implementation, use the notation MCASP_XSTAT_*field_symval*

Table B–205. Transmitter Status Register (XSTAT) Field Values (Continued)

Bit	field [†]	symval [†]	Value	Description
4	XLAST			Transmit last slot flag. XLAST is set along with XDATA, if the current slot is the last slot in a frame. Causes a transmit interrupt (XINT), if this bit is set and XLAST in XINTCTL is set. This bit is cleared by writing a 1 to this bit. Writing a 0 has no effect.
		NO	0	Current slot is not the last slot in a frame.
		YES	1	Current slot is the last slot in a frame. XDATA is also set.
3	XTDMSLOT	OF(<i>value</i>)		Returns the LSB of XSLOT. Allows a single read of XSTAT to determine whether the current TDM time slot is even or odd.
		DEFAULT	0	Current TDM time slot is odd.
			1	Current TDM time slot is even.
2	XCKFAIL			Transmit clock failure flag. XCKFAIL is set when the transmit clock failure detection circuit reports an error. Causes a transmit interrupt (XINT), if this bit is set and XCKFAIL in XINTCTL is set. This bit is cleared by writing a 1 to this bit. Writing a 0 has no effect.
		NO	0	Transmit clock failure did not occur.
		YES	1	Transmit clock failure did occur.
1	XSYNCERR			Unexpected transmit frame sync flag. XSYNCERR is set when a new transmit frame sync (AFSX) occurs before it is expected. Causes a transmit interrupt (XINT), if this bit is set and XSYNCERR in XINTCTL is set. This bit is cleared by writing a 1 to this bit. Writing a 0 has no effect.
		NO	0	Unexpected transmit frame sync did not occur.
		YES	1	Unexpected transmit frame sync did occur.
0	XUNDRN			Transmitter underrun flag. XUNDRN is set when the transmit serializer is instructed to transfer data from XBUF to XRSR, but XBUF has not yet been serviced with new data since the last transfer. Causes a transmit interrupt (XINT), if this bit is set and XUNDRN in XINTCTL is set. This bit is cleared by writing a 1 to this bit. Writing a 0 has no effect.
		NO	0	Transmitter underrun did not occur.
		YES	1	Transmitter underrun did occur.

[†] For CSL implementation, use the notation MCASP_XSTAT_*field_symval*

B.11.34 Current Transmit TDM Time Slot Register (XSLOT)

The current transmit TDM time slot register (XSLOT) indicates the current time slot for the transmit data frame. The XSLOT is shown in Figure B–196 and described in Table B–206.

Figure B–196. Current Transmit TDM Time Slot Register (XSLOT)

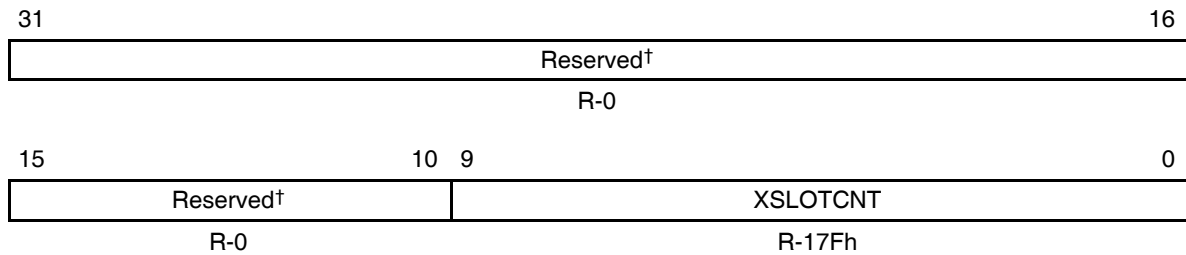

Legend: R = Read only; -n = value after reset

† If writing to this field, always write the default value for future device compatibility.

Table B–206. Current Transmit TDM Time Slot Register (XSLOT) Field Values

Bit	Field	symval†	Value	Description
31–10	Reserved	–	0	Reserved. The reserved bit location always returns the default value. A value written to this field has no effect. If writing to this field, always write the default value for future device compatibility.
9–0	XSLOTCNT	OF(value)	0–17Fh	Current transmit time slot count. Legal values: 0 to 383. During reset, this counter value is 383 so the next count value, which is used to encode the first DIT group of data, will be 0 and encodes the B preamble. TDM function is not supported for >32 time slots. However, TDM time slot counter may count to 383 when used to transmit a DIT block.

† For CSL implementation, use the notation MCASP_XSLOT_XSLOTCNT_symval

B.11.35 Transmit Clock Check Control Register (XCLKCHK)

The transmit clock check control register (XCLKCHK) configures the transmit clock failure detection circuit. The XCLKCHK is shown in Figure B–197 and described in Table B–207.

Figure B–197. Transmit Clock Check Control Register (XCLKCHK)

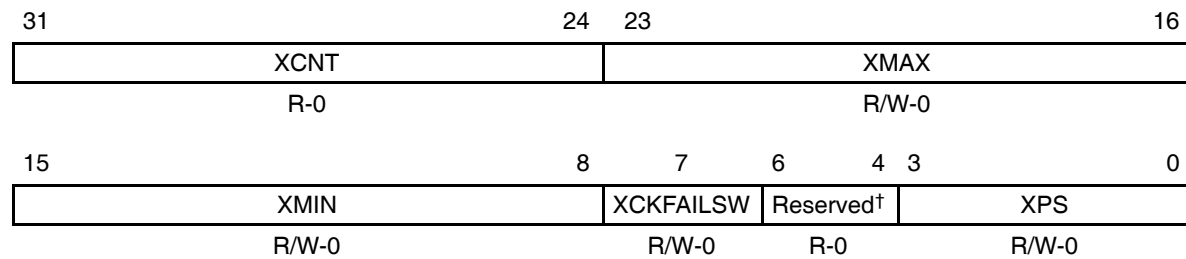

Legend: R = Read only; R/W = Read/Write; -n = value after reset
[†] If writing to this field, always write the default value for future device compatibility.

Table B–207. Transmit Clock Check Control Register (XCLKCHK) Field Values

Bit	field [†]	symval [†]	Value	Description
31–24	XCNT	OF(value)	0–FFh	Transmit clock count value (from previous measurement). The clock circuit continually counts the number of DSP system clocks for every 32 transmit high-frequency master clock (AHCLKX) signals, and stores the count in XCNT until the next measurement is taken.
23–16	XMAX	OF(value)	0–FFh	Transmit clock maximum boundary. This 8-bit unsigned value sets the maximum allowed boundary for the clock check counter after 32 transmit high-frequency master clock (AHCLKX) signals have been received. If the current counter value is greater than XMAX after counting 32 AHCLKX signals, XCKFAIL in XSTAT is set. The comparison is performed using unsigned arithmetic.
15–8	XMIN	OF(value)	0–FFh	Transmit clock minimum boundary. This 8-bit unsigned value sets the minimum allowed boundary for the clock check counter after 32 transmit high-frequency master clock (AHCLKX) signals have been received. If XCNT is less than XMIN after counting 32 AHCLKX signals, XCKFAIL in XSTAT is set. The comparison is performed using unsigned arithmetic.

[†] For CSL implementation, use the notation MCASP_XCLKCHK_field_symval

Table B–207. Transmit Clock Check Control Register (XCLKCHK) Field Values (Continued)

Bit	field [†]	symval [†]	Value	Description
7	XCKFAILSW			Transmit clock failure detect autoswitch enable bit.
		DISABLE	0	Transmit clock failure detect autoswitch is disabled.
		ENABLE	1	Transmit clock failure detect autoswitch is enabled.
6–4	Reserved	–	0	Reserved. The reserved bit location always returns the default value. A value written to this field has no effect. If writing to this field, always write the default value for future device compatibility.
3–0	XPS		0–Fh	Transmit clock check prescaler value.
		DIVBY1	0	McASP system clock divided by 1
		DIVBY2	1h	McASP system clock divided by 2
		DIVBY4	2h	McASP system clock divided by 4
		DIVBY8	3h	McASP system clock divided by 8
		DIVBY16	4h	McASP system clock divided by 16
		DIVBY32	5h	McASP system clock divided by 32
		DIVBY64	6h	McASP system clock divided by 64
		DIVBY128	7h	McASP system clock divided by 128
		DIVBY256	8h	McASP system clock divided by 256
		–	9h–Fh	Reserved

[†] For CSL implementation, use the notation `MCASP_XCLKCHK_field_symval`

B.11.36 Transmitter DMA Event Control Register (XEVTCTL)

The transmitter DMA event control register (XEVTCTL) contains a disable bit for the transmit DMA event. The XEVTCTL is shown in Figure B–198 and described in Table B–208.

DSP specific registers

Accessing XEVTCTL not implemented on a specific DSP may cause improper device operation.

Figure B–198. Transmitter DMA Event Control Register (XEVTCTL)

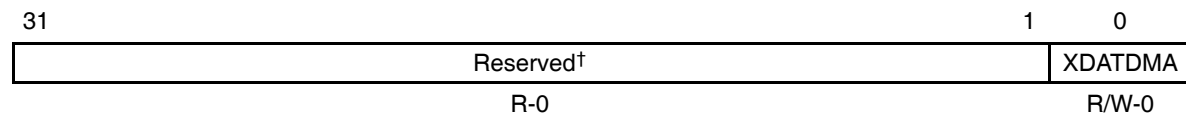

Legend: R = Read only; R/W = Read/Write; -n = value after reset
 † If writing to this field, always write the default value for future device compatibility.

Table B–208. Transmitter DMA Event Control Register (XEVTCTL) Field Values

Bit	field	symval†	Value	Description
31–1	Reserved	–	0	Reserved. The reserved bit location always returns the default value. A value written to this field has no effect. If writing to this field, always write the default value for future device compatibility.
0	XDATDMA			Transmit data DMA request enable bit.
		ENABLE	0	Transmit data DMA request is enabled.
		DISABLE	1	Transmit data DMA request is disabled.

† For CSL implementation, use the notation `MCASP_XEVTCTL_XDATDMA_symval`

B.11.37 Serializer Control Registers (SRCTLn)

Each serializer on the McASP has a serializer control register (SRCTL). There are up to 16 serializers per McASP. The SRCTL is shown in Figure B–199 and described in Table B–209.

DSP specific registers
Accessing SRCTLn not implemented on a specific DSP may cause improper device operation.

Figure B–199. Serializer Control Registers (SRCTLn)

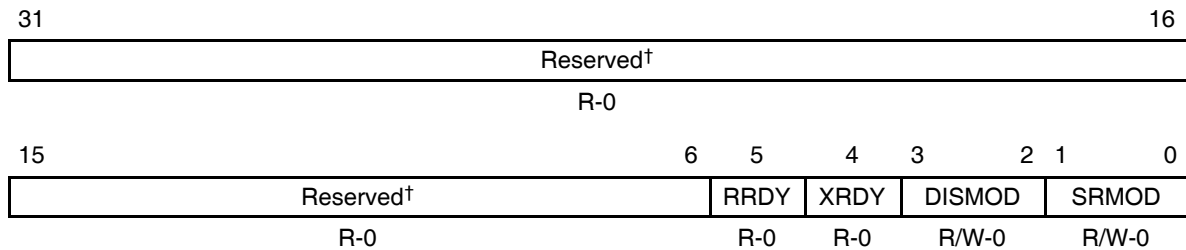

Legend: R = Read only; R/W = Read/Write; -n = value after reset

† If writing to this field, always write the default value for future device compatibility.

Table B–209. Serializer Control Registers (SRCTLn) Field Values

Bit	field	symval†	Value	Description	
31–6	Reserved	–	0	Reserved. The reserved bit location always returns the default value. A value written to this field has no effect. If writing to this field, always write the default value for future device compatibility.	
5	RRDY	OF(value)		Receive buffer ready bit. RRDY indicates the current receive buffer state. Always reads 0 when programmed as a transmitter or as inactive. If SRMOD bit is set to receive (2h), RRDY switches from 0 to 1 whenever data is transferred from XRSR to RBUF.	
			DEFAULT	0	Receive buffer (RBUF) is empty.
				1	Receive buffer (RBUF) contains data and needs to be read before the start of the next time slot or a receiver overrun occurs.

† For CSL implementation, use the notation MCASP_SRCTL_field_symval

Table B–209. Serializer Control Registers (SRCTLn) Field Values (Continued)

Bit	field	symval [†]	Value	Description	
4	XRDY	OF(value)		Transmit buffer ready bit. XRDY indicates the current transmit buffer state. Always reads 0 when programmed as a receiver or as inactive. If SRMOD bit is set to transmit (1h), XRDY switches from 0 to 1 when XSRCLR in GBLCTL is switched from 0 to 1 to indicate an empty transmitter. XRDY remains set until XSRCLR is forced to 0, data is written to the corresponding transmit buffer, or SRMOD bit is changed to receive (2h) or inactive (0).	
			DEFAULT	0	Transmit buffer (XBUF) contains data.
				1	Transmit buffer (XBUF) is empty and needs to be written before the start of the next time slot or a transmit underrun occurs.
3–2	DISMOD		0–3h	Serializer pin drive mode bit. Drive on pin when in inactive TDM slot of transmit mode or when serializer is inactive. This field only applies if the pin is configured as a McASP pin (PFUNC = 0).	
			3STATE	0	Drive on pin is 3-state.
			–	1h	Reserved
			LOW	2h	Drive on pin is logic low.
			HIGH	3h	Drive on pin is logic high.
1–0	SRMOD		0–3h	Serializer mode bit.	
			INACTIVE	0	Serializer is inactive.
			XMT	1h	Serializer is transmitter.
			RCV	2h	Serializer is receiver.
			–	3h	Reserved

[†] For CSL implementation, use the notation MCASP_SRCTL_field_symval

B.11.38 DIT Left Channel Status Registers (DITCSRA0–DITCSRA5)

The DIT left channel status registers (DITCSRA) provide the status of each left channel (even TDM time slot). Each of the six 32-bit registers (Figure B–200) can store 192 bits of channel status data for a complete block of transmission. The DIT reuses the same data for the next block. It is your responsibility to update the register file in time, if a different set of data need to be sent.

Figure B–200. DIT Left Channel Status Registers (DITCSRA0–DITCSRA5)

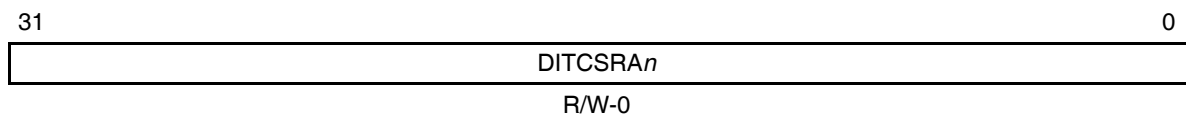

Legend: R/W = Read/Write; -n = value after reset

B.11.39 DIT Right Channel Status Registers (DITCSRB0–DITCSRB5)

The DIT right channel status registers (DITCSRB) provide the status of each right channel (odd TDM time slot). Each of the six 32-bit registers (Figure B–201) can store 192 bits of channel status data for a complete block of transmission. The DIT reuses the same data for the next block. It is your responsibility to update the register file in time, if a different set of data need to be sent.

Figure B–201. DIT Right Channel Status Registers (DITCSRB0–DITCSRB5)

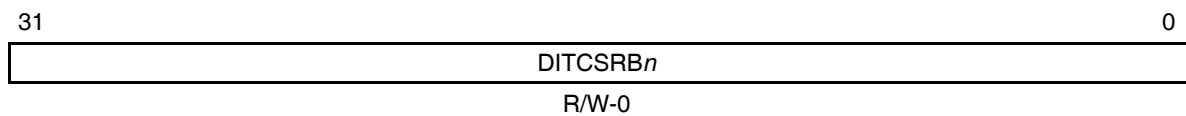

Legend: R/W = Read/Write; -n = value after reset

B.11.40 DIT Left Channel User Data Registers (DITUDRA0–DITUDRA5)

The DIT left channel user data registers (DITUDRA) provides the user data of each left channel (even TDM time slot). Each of the six 32-bit registers (Figure B–202) can store 192 bits of user data for a complete block of transmission. The DIT reuses the same data for the next block. It is your responsibility to update the register in time, if a different set of data need to be sent.

Figure B–202. DIT Left Channel User Data Registers (DITUDRA0–DITUDRA5)

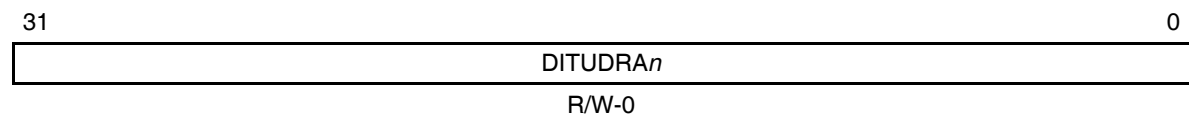

Legend: R/W = Read/Write; -n = value after reset

B.11.41 DIT Right Channel User Data Registers (DITUDRB0–DITUDRB5)

The DIT right channel user data registers (DITUDRB) provides the user data of each right channel (odd TDM time slot). Each of the six 32-bit registers (Figure B–203) can store 192 bits of user data for a complete block of transmission. The DIT reuses the same data for the next block. It is your responsibility to update the register in time, if a different set of data need to be sent.

Figure B–203. DIT Right Channel User Data Registers (DITUDRB0–DITUDRB5)

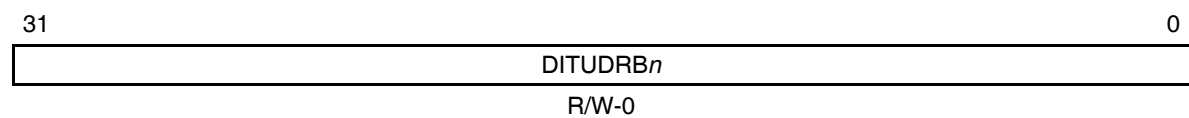

Legend: R/W = Read/Write; -n = value after reset

B.11.42 Transmit Buffer Registers (XBUF_n)

The transmit buffers for the serializers (XBUF) hold data from the transmit format unit. For transmit operations, the XBUF (Figure B–204) is an alias of the XRBUF in the serializer. The XBUF can be accessed through the configuration bus (Table B–256) or through the data port (Table B–172).

DSP specific registers

Accessing XBUF registers not implemented on a specific DSP may cause improper device operation.

Figure B–204. Transmit Buffer Registers (XBUF_n)



Legend: R/W = Read/Write; -n = value after reset

B.11.43 Receive Buffer Registers (RBUF_n)

The receive buffers for the serializers (RBUF) hold data from the serializer before the data goes to the receive format unit. For receive operations, the RBUF (Figure B–205) is an alias of the XRBUF in the serializer. The RBUF can be accessed through the configuration bus (Table B–256) or through the data port (Table B–172).

DSP specific registers

Accessing RBUF registers not implemented on a specific DSP may cause improper device operation.

Figure B–205. Receive Buffer Registers (RBUF_n)

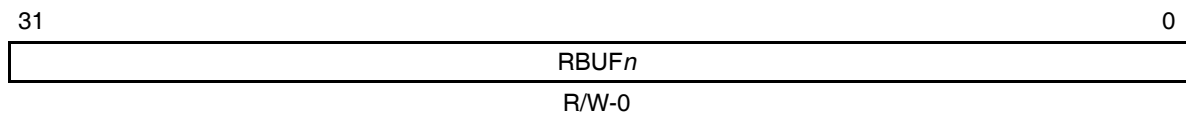

Legend: R/W = Read/Write; -n = value after reset

B.12 Multichannel Buffered Serial Port (McBSP) Registers

Table B–210. McBSP Registers

Acronym	Register Name	Section
DRR	Data receive register	B.12.1
DXR	Data transmit register	B.12.2
SPCR	Serial port control register	B.12.3
PCR	Pin control register	B.12.4
RCR	Receive control register	B.12.5
XCR	Transmit control register	B.12.6
SRGR	Sample rate generator register	B.12.7
MCR	Multichannel control register	B.12.8
RCER	Receive channel enable register	B.12.9
XCER	Transmit channel enable register	B.12.10
RCERE	Enhanced receive channel enable registers (C64x)	B.12.11
XCERE	Enhanced transmit channel enable registers (C64x)	B.12.12

B.12.1 Data Receive Register (DRR)

Figure B–206. Data Receive Register (DRR)

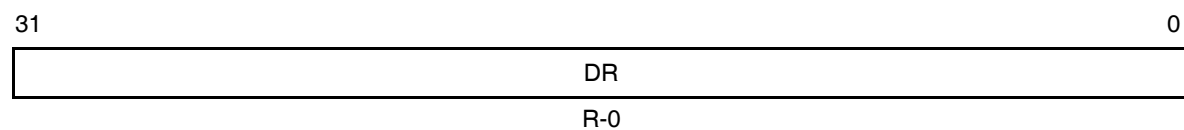

Legend: R/W-x = Read/Write-Reset value

Table B–211. Data Receive Register (DRR) Field Values

Bit	Field	symval [†]	Value	Description
31–0	DR	OF(value)	0–FFFF FFFFh	Data receive register value to be written to the data bus.

[†] For CSL implementation, use the notation MCBSP_DRR_DR_symval.

B.12.2 Data Transmit Register (DXR)

Figure B–207. Data Transmit Register (DXR)

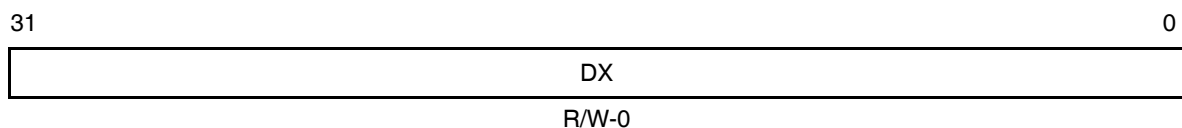

Legend: R/W-x = Read/Write-Reset value

Table B–212. Data Transmit Register (DXR) Field Values

Bit	Field	symval [†]	Value	Description
31–0	DX	OF(value)	0–FFFF FFFFh	Data transmit register value to be loaded into the data transmit shift register (XSR).

[†] For CSL implementation, use the notation MCBSP_DX_R_DX_{_symval}

B.12.3 Serial Port Control Register (SPCR)

Figure B–208. Serial Port Control Register (SPCR)

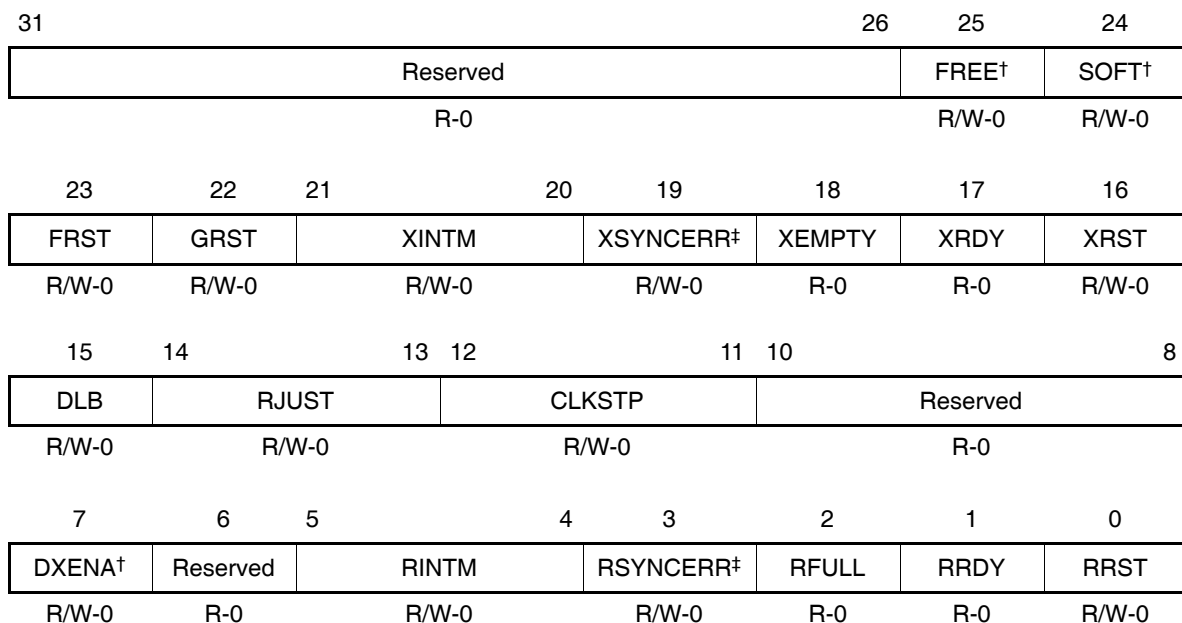

[†] Available in the C621x/C671x/C64x only.

[‡] Writing a 1 to XSYNCERR or RSYNCERR sets the error condition when the transmitter or receiver (XRST=1 or RRST=1), respectively, are enabled. Thus, it is used mainly for testing purposes or if this operation is desired.

Legend: R/W-x = Read/Write-Reset value

Table B–213. Serial Port Control Register (SPCR) Field Values

Bit	field [†]	symval [†]	Value	Description
31–26	Reserved	–	0	Reserved. The reserved bit location is always read as 0. A value written to this field has no effect.
25	FREE			For C621x/C671x and C64x DSP: Free-running enable mode bit. This bit is used in conjunction with SOFT bit to determine state of serial port clock during emulation halt.
		NO	0	Free-running mode is disabled. During emulation halt, SOFT bit determines operation of McBSP.
		YES	1	Free-running mode is enabled. During emulation halt, serial clocks continue to run.
24	SOFT			For C621x/C671x and C64x DSP: Soft bit enable mode bit. This bit is used in conjunction with FREE bit to determine state of serial port clock during emulation halt. This bit has no effect if FREE = 1.
		NO	0	Soft mode is disabled. Serial port clock stops immediately during emulation halt, thus aborting any transmissions.
		YES	1	Soft mode is enabled. During emulation halt, serial port clock stops after completion of current transmission.
23	FRST			Frame-sync generator reset bit.
		YES	0	Frame-synchronization logic is reset. Frame-sync signal (FSG) is not generated by the sample-rate generator.
		NO	1	Frame-sync signal (FSG) is generated after (FPER + 1) number of CLKG clocks; that is, all frame counters are loaded with their programmed values.
22	GRST			Sample-rate generator reset bit.
		YES	0	Sample-rate generator is reset.
		NO	1	Sample-rate generator is taken out of reset. CLKG is driven as per programmed value in sample-rate generator register (SRGR).

[†] For CSL implementation, use the notation `MCBSP_SPCR_field_symval`

Table B–213. Serial Port Control Register (SPCR) Field Values (Continued)

Bit	field [†]	symval [†]	Value	Description
21–20	XINTM		0–3h	Transmit interrupt (XINT) mode bit.
		XRDY	0	XINT is driven by XRDY (end-of-word) and end-of-frame in A-bis mode.
		EOS	1h	XINT is generated by end-of-block or end-of-frame in multichannel operation.
		FRM	2h	XINT is generated by a new frame synchronization.
		XSYNCERR	3h	XINT is generated by XSYNCERR.
19	XSYNCERR			Transmit synchronization error bit. Writing a 1 to XSYNCERR sets the error condition when the transmitter is enabled (XRST = 1). Thus, it is used mainly for testing purposes or if this operation is desired.
		NO	0	No synchronization error is detected.
		YES	1	Synchronization error is detected.
18	XEMPTY			Transmit shift register empty bit.
		YES	0	XSR is empty.
		NO	1	XSR is not empty.
17	XRDY			Transmitter ready bit.
		NO	0	Transmitter is not ready.
		YES	1	Transmitter is ready for new data in DXR.
16	XRST			Transmitter reset bit resets or enables the transmitter.
		YES	0	Serial port transmitter is disabled and in reset state.
		NO	1	Serial port transmitter is enabled.
15	DLB			Digital loop back mode enable bit.
		OFF	0	Digital loop back mode is disabled.
		ON	1	Digital loop back mode is enabled.

[†] For CSL implementation, use the notation `MCBSP_SPCR_field_symval`

Table B–213. Serial Port Control Register (SPCR) Field Values (Continued)

Bit	field [†]	symval [†]	Value	Description	
14–13	RJUST		0–3h	Receive sign-extension and justification mode bit.	
		RZF	0	Right-justify and zero-fill MSBs in DRR.	
		RSE	1h	Right-justify and sign-extend MSBs in DRR.	
		LZF	2h	Left-justify and zero-fill LSBs in DRR.	
		–	3h	Reserved	
12–11	CLKSTP		0–3h	Clock stop mode bit. In SPI mode, operates in conjunction with CLKXP bit of pin control register (PCR).	
		DISABLE	0–1h	Clock stop mode is disabled. Normal clocking for non-SPI mode.	
		In SPI mode with data sampled on rising edge (CLKXP = 0):			
		NODELAY	2h	Clock starts with rising edge without delay.	
		DELAY	3h	Clock starts with rising edge with delay.	
		In SPI mode with data sampled on falling edge (CLKXP = 1):			
		NODELAY	2h	Clock starts with falling edge without delay.	
		DELAY	3h	Clock starts with falling edge with delay.	
10–8	Reserved	–	0	Reserved. The reserved bit location is always read as 0. A value written to this field has no effect.	
7	DXENA			For C621x/C671x and C64x DSP: DX enabler bit.	
		OFF	0	DX enabler is off.	
		ON	1	DX enabler is on.	
6	Reserved	–	0	Reserved. The reserved bit location is always read as 0. A value written to this field has no effect.	

[†] For CSL implementation, use the notation MCBSP_SPCR_field_symval

Table B–213. Serial Port Control Register (SPCR) Field Values (Continued)

Bit	field [†]	symval [†]	Value	Description
5–4	RINTM		0–3h	Receive interrupt (RINT) mode bit.
		RRDY	0	RINT is driven by RRDY (end-of-word) and end-of-frame in A-bis mode.
		EOS	1h	RINT is generated by end-of-block or end-of-frame in multichannel operation.
		FRM	2h	RINT is generated by a new frame synchronization.
		RSYNCERR	3h	RINT is generated by RSYNCERR.
3	RSYNCERR			Receive synchronization error bit. Writing a 1 to RSYNCERR sets the error condition when the receiver is enabled (RRST = 1). Thus, it is used mainly for testing purposes or if this operation is desired.
		NO	0	No synchronization error is detected.
		YES	1	Synchronization error is detected.
2	RFULL			Receive shift register full bit.
		NO	0	RBR is not in overrun condition.
		YES	1	DRR is not read, RBR is full, and RSR is also full with new word.
1	RRDY			Receiver ready bit.
		NO	0	Receiver is not ready.
		YES	1	Receiver is ready with data to be read from DRR.
0	RRST			Receiver reset bit resets or enables the receiver.
		YES	0	The serial port receiver is disabled and in reset state.
		NO	1	The serial port receiver is enabled.

[†] For CSL implementation, use the notation `MCBSP_SPCR_field_symval`

B.12.4 Pin Control Register (PCR)

Figure B–209. Pin Control Register (PCR)

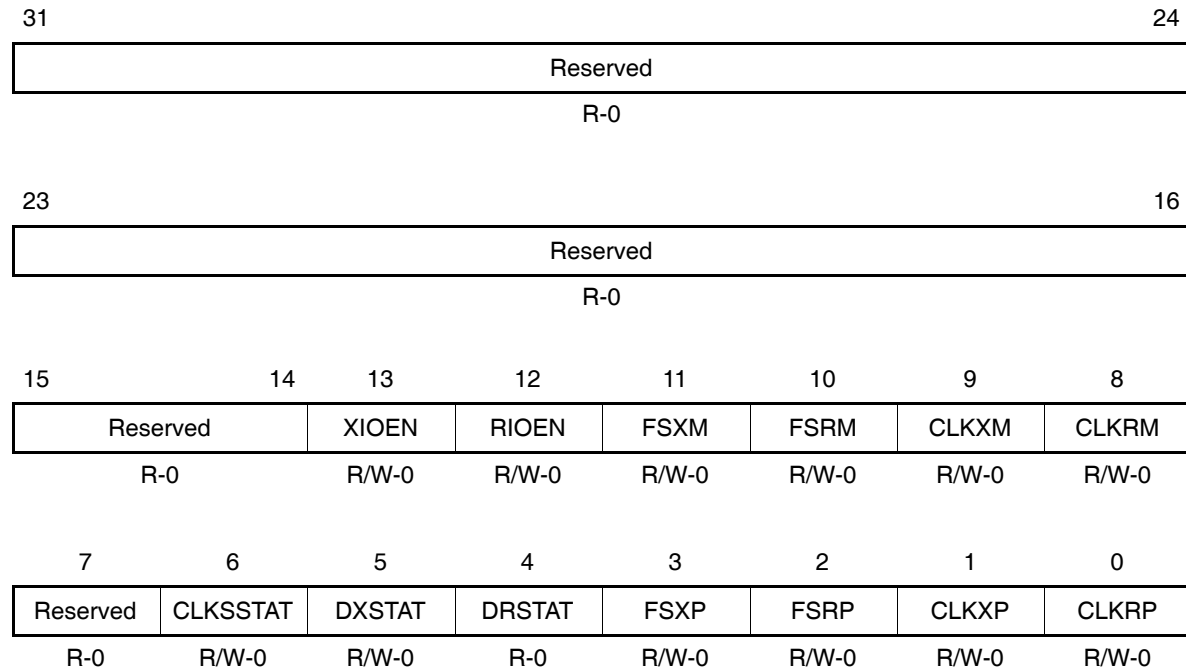

Legend: R/W-x = Read/Write-Reset value

Table B–214. Pin Control Register (PCR) Field Values

No.	field [†]	symval [†]	Value	Function
31–14	Reserved	–	0	Reserved. The reserved bit location is always read as zero. A value written to this field has no effect.
13	XIOEN			Transmit general-purpose I/O mode only when transmitter is disabled (XRST = 0 in SPCR).
		SP	0	DX, FSX, and CLKX pins are configured as serial port pins and do not function as general-purpose I/O pins.
		GPIO	1	DX pin is configured as general-purpose output pin; FSX and CLKX pins are configured as general-purpose I/O pins. These serial port pins do not perform serial port operations.

[†] For CSL implementation, use the notation MCBSP_PCR_field_symval

Table B–214. Pin Control Register (PCR) Field Values (Continued)

No.	field [†]	symval [†]	Value	Function
12	RIOEN			Receive general-purpose I/O mode only when receiver is disabled (RRST = 0 in SPCR).
		SP	0	DR, FSR, CLKR, and CLKS pins are configured as serial port pins and do not function as general-purpose I/O pins.
		GPIO	1	DR and CLKS pins are configured as general-purpose input pins; FSR and CLKR pins are configured as general-purpose I/O pins. These serial port pins do not perform serial port operations.
11	FSXM			Transmit frame-synchronization mode bit.
		EXTERNAL	0	Frame-synchronization signal is derived from an external source.
		INTERNAL	1	Frame-synchronization signal is determined by FSGM bit in SRGR.
10	FSRM			Receive frame-synchronization mode bit.
		EXTERNAL	0	Frame-synchronization signal is derived from an external source. FSR is an input pin.
		INTERNAL	1	Frame-synchronization signal is generated internally by the sample-rate generator. FSR is an output pin, except when GSYNC = 1 in SRGR.
9	CLKXM			Transmitter clock mode bit.
		INPUT	0	CLKX is an input pin and is driven by an external clock.
		OUTPUT	1	CLKX is an output pin and is driven by the internal sample-rate generator.
				In SPI mode when CLKSTP in SPCR is a non-zero value:
		INPUT	0	MCBSP is a slave and clock (CLKX) is driven by the SPI master in the system. CLKR is internally driven by CLKX.
OUTPUT	1	MCBSP is a master and generates the clock (CLKX) to drive its receive clock (CLKR) and the shift clock of the SPI-compliant slaves in the system.		

[†] For CSL implementation, use the notation MCBSP_PCR_field_symval

Table B–214. Pin Control Register (PCR) Field Values (Continued)

No.	field [†]	symval [†]	Value	Function
8	CLKRM			Receiver clock mode bit.
				Digital loop back mode is disabled (DLB = 0 in SPCR):
		INPUT	0	CLKR is an input pin and is driven by an external clock.
		OUTPUT	1	CLKR is an output pin and is driven by the internal sample-rate generator.
				Digital loop back mode is enabled (DLB = 1 in SPCR):
		INPUT	0	Receive clock (not the CLKR pin) is driven by transmit clock (CLKX) that is based on CLKXM bit. CLKR pin is in high-impedance state.
		OUTPUT	1	CLKR is an output pin and is driven by the transmit clock. The transmit clock is based on CLKXM bit.
7	Reserved	–	0	Reserved. The reserved bit location is always read as zero. A value written to this field has no effect.
6	CLKSSTAT			CLKS pin status reflects value on CLKS pin when configured as a general-purpose input pin.
		0	0	CLKS pin reflects a logic low.
		1	1	CLKS pin reflects a logic high.
5	DXSTAT			DX pin status reflects value driven to DX pin when configured as a general-purpose output pin.
		0	0	DX pin reflects a logic low.
		1	1	DX pin reflects a logic high.
4	DRSTAT			DR pin status reflects value on DR pin when configured as a general-purpose input pin.
		0	0	DR pin reflects a logic low.
		1	1	DR pin reflects a logic high.
3	FSXP			Transmit frame-synchronization polarity bit.
		ACTIVEHIGH	0	Transmit frame-synchronization pulse is active high.
		ACTIVELOW	1	Transmit frame-synchronization pulse is active low.

[†] For CSL implementation, use the notation MCBSP_PCR_field_symval

Table B–214. Pin Control Register (PCR) Field Values (Continued)

No.	field [†]	symval [†]	Value	Function
2	FSRP			Receive frame-synchronization polarity bit.
		ACTIVEHIGH	0	Receive frame-synchronization pulse is active high.
		ACTIVELOW	1	Receive frame-synchronization pulse is active low.
1	CLKXP			Transmit clock polarity bit.
		RISING	0	Transmit data sampled on rising edge of CLKX.
		FALLING	1	Transmit data sampled on falling edge of CLKX.
0	CLKRP			Receive clock polarity bit.
		FALLING	0	Receive data sampled on falling edge of CLKR.
		RISING	1	Receive data sampled on rising edge of CLKR.

[†] For CSL implementation, use the notation MCBSP_PCR_field_symval

B.12.5 Receive Control Register (RCR)

Figure B–210. Receive Control Register (RCR)

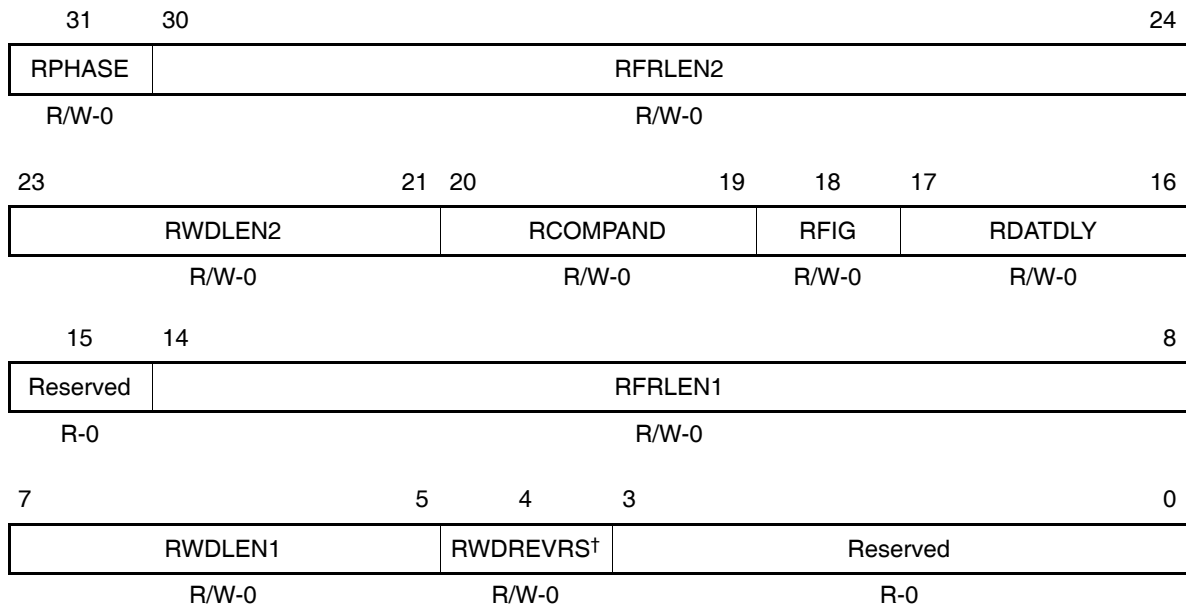

Legend: R/W-x = Read/Write-Reset value

Table B–215. Receive Control Register (RCR) Field Values

Bit	field [†]	symval [†]	Value	Description
31	RPHASE			Receive phases bit.
		SINGLE	0	Single-phase frame
		DUAL	1	Dual-phase frame
30–24	RFRLLEN2	OF(<i>value</i>)	0–7Fh	Specifies the receive frame length (number of words) in phase 2.
23–21	RWDLEN2		0–7h	Specifies the receive word length (number of bits) in phase 2.
		8BIT	0	Receive word length is 8 bits.
		12BIT	1h	Receive word length is 12 bits.
		16BIT	2h	Receive word length is 16 bits.
		20BIT	3h	Receive word length is 20 bits.
		24BIT	4h	Receive word length is 24 bits.
		32BIT	5h	Receive word length is 32 bits.
–	–	6h–7h	Reserved	
20–19	RCOMPAND		0–3h	Receive companding mode bit. Modes other than 00 are only enabled when RWDLEN1/2 bit is 000 (indicating 8-bit data).
		MSB	0	No companding, data transfer starts with MSB first.
		8BITLSB	1h	No companding, 8-bit data transfer starts with LSB first.
		ULAW	2h	Compand using μ -law for receive data.
		ALAW	3h	Compand using A-law for receive data.
18	RFIG			Receive frame ignore bit.
		NO	0	Receive frame-synchronization pulses after the first pulse restarts the transfer.
		YES	1	Receive frame-synchronization pulses after the first pulse are ignored.

[†] For CSL implementation, use the notation MCBSP_RCR_field_symval

Table B–215. Receive Control Register (RCR) Field Values (Continued)

Bit	field [†]	symval [†]	Value	Description
17–16	RDATDLY		0–3h	Receive data delay bit.
		0BIT	0	0-bit data delay
		1BIT	1h	1-bit data delay
		2BIT	2h	2-bit data delay
		–	3h	Reserved
15	Reserved	–	0	Reserved. The reserved bit location is always read as 0. A value written to this field has no effect.
14–8	RFRLLEN1	OF(value)	0–7Fh	Specifies the receive frame length (number of words) in phase 1.
7–5	RWDLEN1		0–7h	Specifies the receive word length (number of bits) in phase 1.
		8BIT	0	Receive word length is 8 bits.
		12BIT	1h	Receive word length is 12 bits.
		16BIT	2h	Receive word length is 16 bits.
		20BIT	3h	Receive word length is 20 bits.
		24BIT	4h	Receive word length is 24 bits.
		32BIT	5h	Receive word length is 32 bits.
		–	6h–7h	Reserved
4	RWDREVRS			For C621x/C671x and C64x DSP: Receive 32-bit bit reversal enable bit.
		DISABLE	0	32-bit bit reversal is disabled.
		ENABLE	1	32-bit bit reversal is enabled. 32-bit data is received LSB first. RWDLEN1/2 bit should be set to 5h (32-bit operation); RCOMPAND bit should be set to 1h (transfer starts with LSB first); otherwise, operation is undefined.
3–0	Reserved	–	0	Reserved. The reserved bit location is always read as 0. A value written to this field has no effect.

[†] For CSL implementation, use the notation `MCBSP_RCR_field_symval`

B.12.6 Transmit Control Register (XCR)

Figure B–211. Transmit Control Register (XCR)

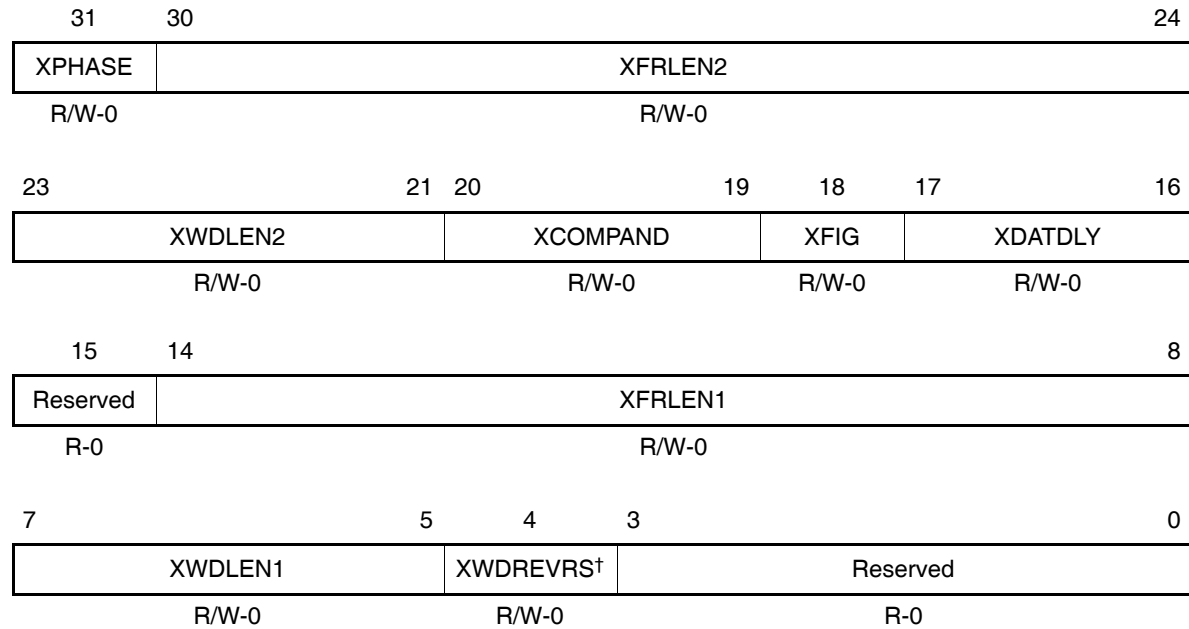

Legend: R/W-x = Read/Write-Reset value

Table B–216. Transmit Control Register (XCR) Field Values

Bit	field [†]	symval [†]	Value	Description
31	XPHASE			Transmit phases bit.
		SINGLE	0	Single-phase frame
		DUAL	1	Dual-phase frame
30–24	XFRLEN2	OF(<i>value</i>)	0–7Fh	Specifies the transmit frame length (number of words) in phase 2.

[†] For CSL implementation, use the notation `MCBSP_XCR_field_symval`

Table B–216. Transmit Control Register (XCR) Field Values (Continued)

Bit	field [†]	symval [†]	Value	Description
23–21	XWDLEN2		0–7h	Specifies the transmit word length (number of bits) in phase 2.
		8BIT	0	Transmit word length is 8 bits.
		12BIT	1h	Transmit word length is 12 bits.
		16BIT	2h	Transmit word length is 16 bits.
		20BIT	3h	Transmit word length is 20 bits.
		24BIT	4h	Transmit word length is 24 bits.
		32BIT	5h	Transmit word length is 32 bits.
		–	6h–7h	Reserved
20–19	XCOMPAND		0–3h	Transmit companding mode bit. Modes other than 00 are only enabled when XWDLEN1/2 bit is 000 (indicating 8-bit data).
		MSB	0	No companding, data transfer starts with MSB first.
		8BITLSB	1h	No companding, 8-bit data transfer starts with LSB first.
		ULAW	2h	Compand using μ -law for transmit data.
		ALAW	3h	Compand using A-law for transmit data.
18	XFIG			Transmit frame ignore bit.
		NO	0	Transmit frame-synchronization pulses after the first pulse restarts the transfer.
		YES	1	Transmit frame-synchronization pulses after the first pulse are ignored.
17–16	XDATDLY		0–3h	Transmit data delay bit.
		0BIT	0	0-bit data delay
		1BIT	1h	1-bit data delay
		2BIT	2h	2-bit data delay
		–	3h	Reserved
15	Reserved	–	0	Reserved. The reserved bit location is always read as 0. A value written to this field has no effect.
14–8	XFRLEN1	OF(value)	0–7Fh	Specifies the transmit frame length (number of words) in phase 1.

[†] For CSL implementation, use the notation `MCBSP_XCR_field_symval`

Table B–216. Transmit Control Register (XCR) Field Values (Continued)

Bit	field [†]	symval [†]	Value	Description
7–5	XWDLEN1		0–7h	Specifies the transmit word length (number of bits) in phase 1.
		8BIT	0	Transmit word length is 8 bits.
		12BIT	1h	Transmit word length is 12 bits.
		16BIT	2h	Transmit word length is 16 bits.
		20BIT	3h	Transmit word length is 20 bits.
		24BIT	4h	Transmit word length is 24 bits.
		32BIT	5h	Transmit word length is 32 bits.
		–	6h–7h	Reserved
4	XWDREVRS			For C621x/C671x and C64x DSP: Transmit 32-bit bit reversal feature enable bit.
		DISABLE	0	32-bit bit reversal is disabled.
		ENABLE	1	32-bit bit reversal is enabled. 32-bit data is transmitted LSB first. XWDLEN1/2 bit should be set to 5h (32-bit operation); XCOMPAND bit should be set to 1h (transfer starts with LSB first); otherwise, operation is undefined.
3–0	Reserved	–	0	Reserved. The reserved bit location is always read as 0. A value written to this field has no effect.

[†] For CSL implementation, use the notation `MCBSP_XCR_field_symval`

B.12.7 Sample Rate Generator Register (SRGR)

Figure B–212. Sample Rate Generator Register (SRGR)

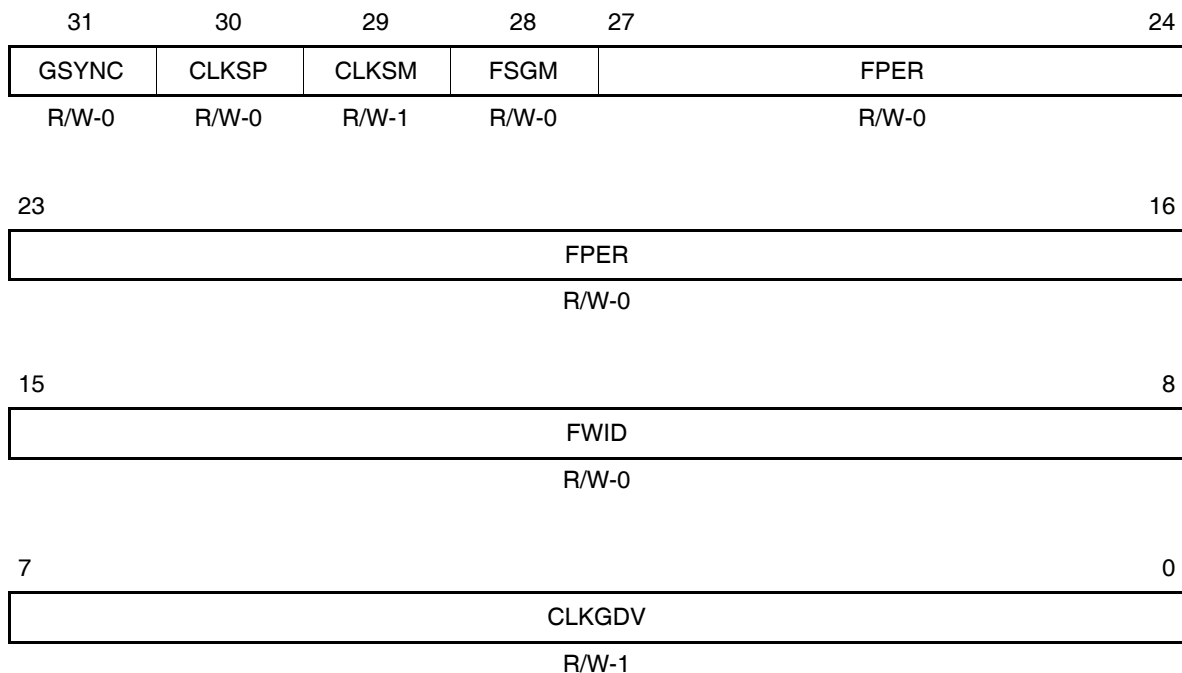

Legend: R/W-x = Read/Write-Reset value

Table B–217. Sample Rate Generator Register (SRGR) Field Values

Bit	field [†]	symval [†]	Value	Description
31	GSYNC			Sample-rate generator clock synchronization bit only used when the external clock (CLKS) drives the sample-rate generator clock (CLKSM = 0).
		FREE	0	The sample-rate generator clock (CLKG) is free running.
		SYNC	1	The sample-rate generator clock (CLKG) is running; however, CLKG is resynchronized and frame-sync signal (FSG) is generated only after detecting the receive frame-synchronization signal (FSR). Also, frame period (FPER) is a don't care because the period is dictated by the external frame-sync pulse.

[†] For CSL implementation, use the notation `MCBSP_SRGR_field_symval`

Table B–217. Sample Rate Generator Register (SRGR) Field Values (Continued)

Bit	field [†]	symval [†]	Value	Description
30	CLKSP			CLKS polarity clock edge select bit only used when the external clock (CLKS) drives the sample-rate generator clock (CLKSM = 0).
		RISING	0	Rising edge of CLKS generates CLKG and FSG.
		FALLING	1	Falling edge of CLKS generates CLKG and FSG.
29	CLKSM			MCBSP sample-rate generator clock mode bit.
		CLKS	0	Sample-rate generator clock derived from the CLKS pin.
		INTERNAL	1	Sample-rate generator clock derived from CPU clock.
28	FSGM			Sample-rate generator transmit frame-synchronization mode bit used when FSXM = 1 in PCR.
		DXR2XSR	0	Transmit frame-sync signal (FSX) due to DXR-to-XSR copy. When FSGM = 0, FWID bit and FPER bit are ignored.
		FSG	1	Transmit frame-sync signal (FSX) driven by the sample-rate generator frame-sync signal (FSG).
27–16	FPER	OF(value)	0–FFFh	The value plus 1 specifies when the next frame-sync signal becomes active. Range: 1 to 4096 sample-rate generator clock (CLKG) periods.
15–8	FWID	OF(value)	0–FFh	The value plus 1 specifies the width of the frame-sync pulse (FSG) during its active period.
7–0	CLKGDV	OF(value)	0–FFh	The value is used as the divide-down number to generate the required sample-rate generator clock frequency.

[†] For CSL implementation, use the notation MCBSP_SRGR_field_symval

B.12.8 Multichannel Control Register (MCR)

Figure B–213. Multichannel Control Register (MCR)

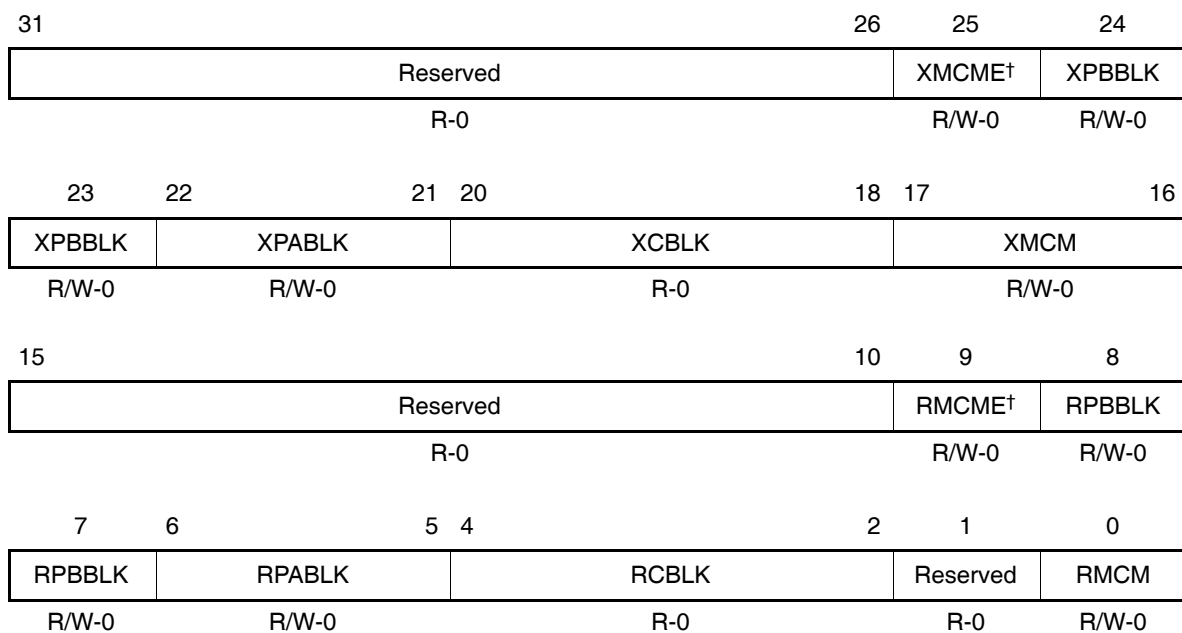

† XMCME and RMCME are only available on C64x devices. These bit fields are Reserved (R-0) on all other C6000 devices.

Legend: R/W-x = Read/Write-Reset value

Table B–218. Multichannel Control Register (MCR) Field Values

Bit	field†	symval†	Value	Description
31–26	Reserved	–	0	Reserved. The reserved bit location is always read as zero. A value written to this field has no effect.
25	XMCME			For devices with 128-channel selection capability: Transmit 128-channel selection enable bit.
		NORMAL	0	Normal 32-channel selection is enabled.
		ENHANCED	1	Six additional registers (XCERC–XCERH) are used to enable 128-channel selection.

† For CSL implementation, use the notation `MCBSP_MCR_field_symval`

‡ DX is masked or driven to a high-impedance state during (a) interpacket intervals, (b) when a channel is masked regardless of whether it is enabled, or (c) when a channel is disabled.

Table B–218. Multichannel Control Register (MCR) Field Values (Continued)

Bit	field [†]	symval [†]	Value	Description
24–23	XPBBLK		0–3h	Transmit partition B block bit. Enables 16 contiguous channels in each block.
		SF1	0	Block 1. Channel 16 to channel 31
		SF3	1h	Block 3. Channel 48 to channel 63
		SF5	2h	Block 5. Channel 80 to channel 95
		SF7	3h	Block 7. Channel 112 to channel 127
22–21	XPABLK		0–3h	Transmit partition A block bit. Enables 16 contiguous channels in each block.
		SF0	0	Block 0. Channel 0 to channel 15
		SF2	1h	Block 2. Channel 32 to channel 47
		SF4	2h	Block 4. Channel 64 to channel 79
		SF6	3h	Block 6. Channel 96 to channel 111
20–18	XCBLK		0–7h	Transmit current block bit.
		SF0	0	Block 0. Channel 0 to channel 15
		SF1	1h	Block 1. Channel 16 to channel 31
		SF2	2h	Block 2. Channel 32 to channel 47
		SF3	3h	Block 3. Channel 48 to channel 63
		SF4	4h	Block 4. Channel 64 to channel 79
		SF5	5h	Block 5. Channel 80 to channel 95
		SF7	7h	Block 7. Channel 112 to channel 127

[†] For CSL implementation, use the notation `MCBSP_MCR_field_symval`

[‡] DX is masked or driven to a high-impedance state during (a) interpacket intervals, (b) when a channel is masked regardless of whether it is enabled, or (c) when a channel is disabled.

Table B–218. Multichannel Control Register (MCR) Field Values (Continued)

Bit	field [†]	symval [†]	Value	Description
17–16	XMCM		0–3h	Transmit multichannel selection enable bit.
		ENNOMASK	0	All channels enabled without masking (DX is always driven during transmission of data). [‡]
		DISXP	1h	All channels disabled and, therefore, masked by default. Required channels are selected by enabling XP[A, B]BLK and XCER[A, B] appropriately. Also, these selected channels are not masked and, therefore, DX is always driven.
		ENMASK	2h	All channels enabled, but masked. Selected channels enabled using XP[A, B]BLK and XCER[A, B] are unmasked.
		DISRP	3h	All channels disabled and, therefore, masked by default. Required channels are selected by enabling RP[A, B]BLK and RCER[A, B] appropriately. Selected channels can be unmasked by RP[A, B]BLK and XCER[A, B]. This mode is used for symmetric transmit and receive operation.
15–10	Reserved	–	0	Reserved. The reserved bit location is always read as zero. A value written to this field has no effect.
9	RMCME			For devices with 128-channel selection capability: Receive 128-channel selection enable bit.
		NORMAL	0	Normal 32-channel selection is enabled.
		ENHANCED	1	Six additional registers (RCERC–RCERH) are used to enable 128-channel selection.
8–7	RPBBLK		0–3h	Receive partition B block bit. Enables 16 contiguous channels in each block.
		SF1	0	Block 1. Channel 16 to channel 31
		SF3	1h	Block 3. Channel 48 to channel 63
		SF5	2h	Block 5. Channel 80 to channel 95
		SF7	3h	Block 7. Channel 112 to channel 127

[†] For CSL implementation, use the notation MCBSP_MCR_field_symval

[‡] DX is masked or driven to a high-impedance state during (a) interpacket intervals, (b) when a channel is masked regardless of whether it is enabled, or (c) when a channel is disabled.

Table B–218. Multichannel Control Register (MCR) Field Values (Continued)

Bit	field [†]	symval [†]	Value	Description
6–5	RPABLK		0–3h	Receive partition A block bit. Enables 16 contiguous channels in each block.
		SF0	0	Block 0. Channel 0 to channel 15
		SF2	1h	Block 2. Channel 32 to channel 47
		SF4	2h	Block 4. Channel 64 to channel 79
		SF6	3h	Block 6. Channel 96 to channel 111
4–2	RCBLK		0–7h	Receive current block bit.
		SF0	0	Block 0. Channel 0 to channel 15
		SF1	1h	Block 1. Channel 16 to channel 31
		SF2	2h	Block 2. Channel 32 to channel 47
		SF3	3h	Block 3. Channel 48 to channel 63
		SF4	4h	Block 4. Channel 64 to channel 79
		SF5	5h	Block 5. Channel 80 to channel 95
		SF6	6h	Block 6. Channel 96 to channel 111
		SF7	7h	Block 7. Channel 112 to channel 127
1	Reserved	–	0	Reserved. The reserved bit location is always read as zero. A value written to this field has no effect.
0	RMCM			Receive multichannel selection enable bit.
		CHENABLE	0	All 128 channels enabled.
		ELDISABLE	1	All channels disabled by default. Required channels are selected by enabling RP[A, B]BLK and RCER[A, B] appropriately.

[†] For CSL implementation, use the notation `MCBSP_MCR_field_symval`

[‡] DX is masked or driven to a high-impedance state during (a) interpacket intervals, (b) when a channel is masked regardless of whether it is enabled, or (c) when a channel is disabled.

B.12.9 Receive Channel Enable Register (RCER) (C62x/C67x)

Figure B–214. Receive Channel Enable Register (RCER)

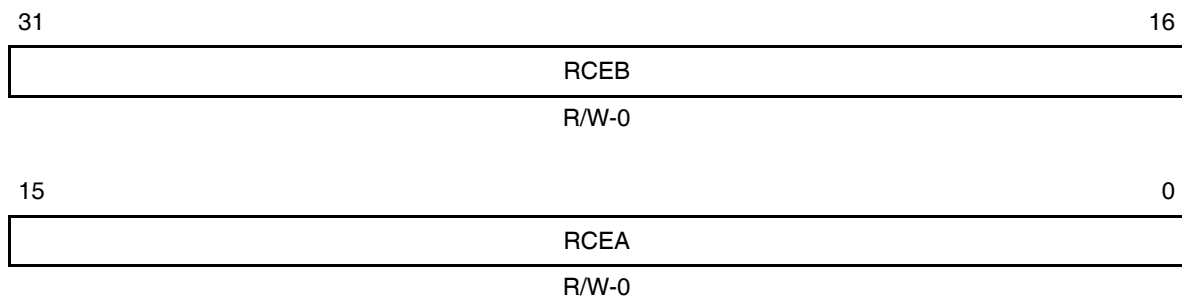

Legend: R/W-x = Read/Write-Reset value

Table B–219. Receive Channel Enable Register (RCER) Field Values

Bit	field [†]	symval [†]	Value	Description
31–16	RCEB	OF(value)	0–FFFFh	A 16-bit unsigned value used to disable (bit value = 0) or enable (bit value = 1) reception of the <i>n</i> th channel within the 16-channel-wide block in partition B. The 16-channel-wide block is selected by the RPBBLK bit in MCR.
15–0	RCEA	OF(value)	0–FFFFh	A 16-bit unsigned value used to disable (bit value = 0) or enable (bit value = 1) reception of the <i>n</i> th channel within the 16-channel-wide block in partition A. The 16-channel-wide block is selected by the RPABLK bit in MCR.

[†] For CSL implementation, use the notation `MCBSP_RCER_field_symval`

B.12.10 Transmit Channel Enable Register (XCER) (C62x/C67x)

Figure B–215. Transmit Channel Enable Register (XCER)

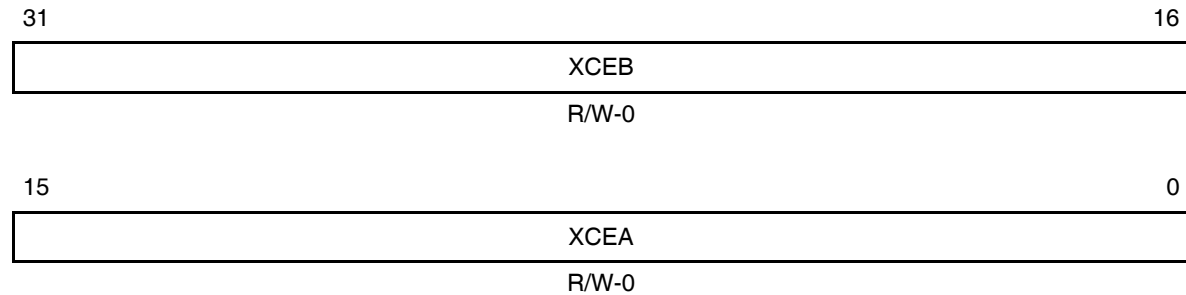

Legend: R/W-x = Read/Write-Reset value

Table B–220. Transmit Channel Enable Register (XCER) Field Values

Bit	field [†]	symval [†]	Value	Description
31–16	XCEB	OF(value)	0–FFFFh	A 16-bit unsigned value used to disable (bit value = 0) or enable (bit value = 1) transmission of the <i>n</i> th channel within the 16-channel-wide block in partition B. The 16-channel-wide block is selected by the XPBBLK bit in MCR.
15–0	XCEA	OF(value)	0–FFFFh	A 16-bit unsigned value used to disable (bit value = 0) or enable (bit value = 1) transmission of the <i>n</i> th channel within the 16-channel-wide block in partition A. The 16-channel-wide block is selected by the XPABLK bit in MCR.

[†] For CSL implementation, use the notation `MCBSP_XCER_field_symval`

B.12.11 Enhanced Receive Channel Enable Registers (RCERE0–3) (C64x)

The enhanced receive channel enable registers (RCERE0, RCERE1, RCERE2, and RCERE3) are used to enable any of the 128 elements for receive. Partitions A and B do not apply to the enhanced multichannel selection mode; therefore, the bit fields in RCERE0–3 are numbered from 0 to 127, representing the 128 channels. The RCERE n is shown in Figure B–216 and described in Table B–221. Table B–222 shows the 128 channels in a multichannel data stream and their corresponding enable bits in RCERE n .

Figure B–216. Enhanced Receive Channel Enable Registers (RCERE0–3)

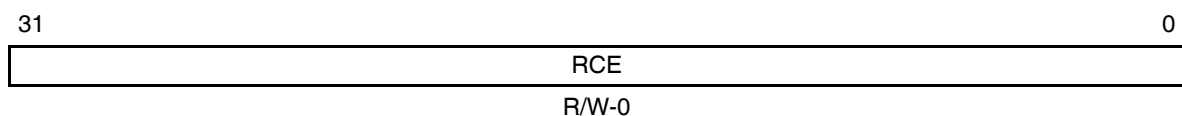

Legend: R/W = Read/Write; - n = value after reset

Table B–221. Enhanced Receive Channel Enable Registers (RCERE0–3) Field Values

Bit	Field	symval [†]	Value	Description
31–0	RCE	OF(<i>value</i>)	0–FFFF FFFFh	A 32-bit unsigned value used to disable (bit value = 0) or enable (bit value = 1) reception of the n th channel of the 128 elements. See Table B–222 for the bit number of a specific channel.

[†] For CSL implementation, use the notation MCBSP_RCERE n _RCE_*symval*, where n is the register number, 0–3.

Table B–222. Channel Enable Bits in RCEREn for a 128-Channel Data Stream

RCEREn Bit	Channel Number of a 128-Channel Data Stream (RCEn)							
	0 - 15	16 - 31	32 - 47	48 - 63	64 - 79	80 - 95	96 - 111	112-127
0	RCERE0		RCERE1		RCERE2		RCERE3	
1	RCERE0		RCERE1		RCERE2		RCERE3	
2	RCERE0		RCERE1		RCERE2		RCERE3	
3	RCERE0		RCERE1		RCERE2		RCERE3	
4	RCERE0		RCERE1		RCERE2		RCERE3	
5	RCERE0		RCERE1		RCERE2		RCERE3	
6	RCERE0		RCERE1		RCERE2		RCERE3	
7	RCERE0		RCERE1		RCERE2		RCERE3	
8	RCERE0		RCERE1		RCERE2		RCERE3	
9	RCERE0		RCERE1		RCERE2		RCERE3	
10	RCERE0		RCERE1		RCERE2		RCERE3	
11	RCERE0		RCERE1		RCERE2		RCERE3	
12	RCERE0		RCERE1		RCERE2		RCERE3	
13	RCERE0		RCERE1		RCERE2		RCERE3	
14	RCERE0		RCERE1		RCERE2		RCERE3	
15	RCERE0		RCERE1		RCERE2		RCERE3	
16		RCERE0		RCERE1		RCERE2		RCERE3
17		RCERE0		RCERE1		RCERE2		RCERE3
18		RCERE0		RCERE1		RCERE2		RCERE3
19		RCERE0		RCERE1		RCERE2		RCERE3
20		RCERE0		RCERE1		RCERE2		RCERE3
21		RCERE0		RCERE1		RCERE2		RCERE3
22		RCERE0		RCERE1		RCERE2		RCERE3
23		RCERE0		RCERE1		RCERE2		RCERE3
24		RCERE0		RCERE1		RCERE2		RCERE3
25		RCERE0		RCERE1		RCERE2		RCERE3
26		RCERE0		RCERE1		RCERE2		RCERE3
27		RCERE0		RCERE1		RCERE2		RCERE3
28		RCERE0		RCERE1		RCERE2		RCERE3
29		RCERE0		RCERE1		RCERE2		RCERE3
30		RCERE0		RCERE1		RCERE2		RCERE3
31		RCERE0		RCERE1		RCERE2		RCERE3

B.12.12 Enhanced Transmit Channel Enable Registers (XCERE0–3) (C64x)

The enhanced transmit channel enable registers (XCERE0, XCERE1, XCERE2, and XCERE3) are used to enable any of the 128 elements for transmit. Partitions A and B do not apply to the enhanced multichannel selection mode; therefore, the bit fields in XCERE0–3 are numbered from 0 to 127, representing the 128 channels. The XCEREn is shown in Figure B–217 and described in Table B–223. Table B–224 shows the 128 channels in a multichannel data stream and their corresponding enable bits in XCEREn.

Figure B–217. Enhanced Transmit Channel Enable Registers (XCERE0–3)

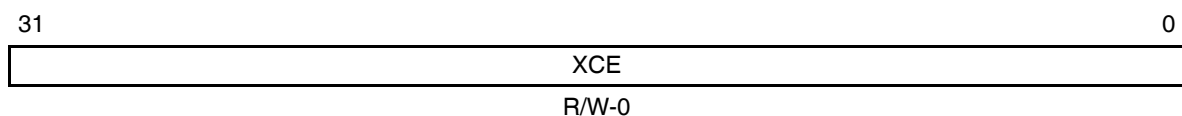

Legend: R/W = Read/Write; -n = value after reset

Table B–223. Enhanced Transmit Channel Enable Registers (XCERE0–3) Field Values

Bit	Field	symval [†]	Value	Description
31–0	XCE	OF(value)	0–FFFF FFFFh	A 32-bit unsigned value used to disable (bit value = 0) or enable (bit value = 1) transmission of the <i>n</i> th channel of the 128 elements. See Table B–224 for the bit number of a specific channel.

[†] For CSL implementation, use the notation MCBSP_XCEREn_XCE_symval, where *n* is the register number, 0–3.

Table B–224. Channel Enable Bits in XCEREn for a 128-Channel Data Stream

XCEREn Bit	Channel Number of a 128-Channel Data Stream (XCEn)							
	0 - 15	16 - 31	32 - 47	48 - 63	64 - 79	80 - 95	96 - 111	112-127
0	XCERE0		XCERE1		XCERE2		XCERE3	
1	XCERE0		XCERE1		XCERE2		XCERE3	
2	XCERE0		XCERE1		XCERE2		XCERE3	
3	XCERE0		XCERE1		XCERE2		XCERE3	
4	XCERE0		XCERE1		XCERE2		XCERE3	
5	XCERE0		XCERE1		XCERE2		XCERE3	
6	XCERE0		XCERE1		XCERE2		XCERE3	
7	XCERE0		XCERE1		XCERE2		XCERE3	
8	XCERE0		XCERE1		XCERE2		XCERE3	
9	XCERE0		XCERE1		XCERE2		XCERE3	
10	XCERE0		XCERE1		XCERE2		XCERE3	
11	XCERE0		XCERE1		XCERE2		XCERE3	
12	XCERE0		XCERE1		XCERE2		XCERE3	
13	XCERE0		XCERE1		XCERE2		XCERE3	
14	XCERE0		XCERE1		XCERE2		XCERE3	
15	XCERE0		XCERE1		XCERE2		XCERE3	
16		XCERE0		XCERE1		XCERE2		XCERE3
17		XCERE0		XCERE1		XCERE2		XCERE3
18		XCERE0		XCERE1		XCERE2		XCERE3
19		XCERE0		XCERE1		XCERE2		XCERE3
20		XCERE0		XCERE1		XCERE2		XCERE3
21		XCERE0		XCERE1		XCERE2		XCERE3
22		XCERE0		XCERE1		XCERE2		XCERE3
23		XCERE0		XCERE1		XCERE2		XCERE3
24		XCERE0		XCERE1		XCERE2		XCERE3
25		XCERE0		XCERE1		XCERE2		XCERE3
26		XCERE0		XCERE1		XCERE2		XCERE3
27		XCERE0		XCERE1		XCERE2		XCERE3
28		XCERE0		XCERE1		XCERE2		XCERE3
29		XCERE0		XCERE1		XCERE2		XCERE3
30		XCERE0		XCERE1		XCERE2		XCERE3
31		XCERE0		XCERE1		XCERE2		XCERE3

B.13 MDIO Module Registers

Control registers for the MDIO module are summarized in Table B–225. See the device-specific datasheet for the memory address of these registers.

Table B–225. MDIO Module Registers

Acronym	Register Name	Section
VERSION	MDIO Version Register	B.13.1
CONTROL	MDIO Control Register	B.13.2
ALIVE	MDIO PHY Alive Indication Register	B.13.3
LINK	MDIO PHY Link Status Register	B.13.4
LINKINTRAW	MDIO Link Status Change Interrupt Register	B.13.5
LINKINTMASKED	MDIO Link Status Change Interrupt (Masked) Register	B.13.6
USERINTRAW	MDIO User Command Complete Interrupt Register	B.13.7
USERINTMASKED	MDIO User Command Complete Interrupt (Masked) Register	B.13.8
USERINTMASKSET	MDIO User Command Complete Interrupt Mask Set Register	B.13.9
USERINTMASKCLEAR	MDIO User Command Complete Interrupt Mask Clear Register	B.13.10
USERACCESS0	MDIO User Access Register 0	B.13.11
USERACCESS1	MDIO User Access Register 1	B.13.12
USERPHYSEL0	MDIO User PHY Select Register 0	B.13.13
USERPHYSEL1	MDIO User PHY Select Register 1	B.13.14

B.13.1 MDIO Version Register (VERSION)

The MDIO version register (VERSION) is shown in Figure B–218 and described in Table B–226.

Figure B–218. MDIO Version Register (VERSION)

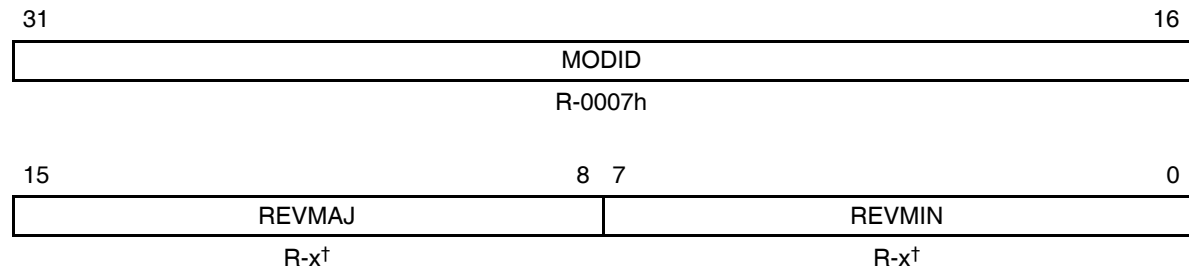

Legend: R = Read only; -n = value after reset

† See the device-specific datasheet for the default value of this field.

Table B–226. MDIO Version Register (VERSION) Field Values

Bit	field†	symval†	Value	Description
31–16	MODID		7h	Identifies type of peripheral. MDIO
15–8	REVMAJ		x	Identifies major revision of peripheral. See the device-specific datasheet for the value.
7–0	REVMIN		x	Identifies minor revision of peripheral. See the device-specific datasheet for the value.

† For CSL implementation, use the notation MDIO_VERSION_field_symval

B.13.2 MDIO Control Register (CONTROL)

The MDIO control register (CONTROL) is shown in Figure B–219 and described in Table B–227.

Figure B–219. MDIO Control Register (CONTROL)

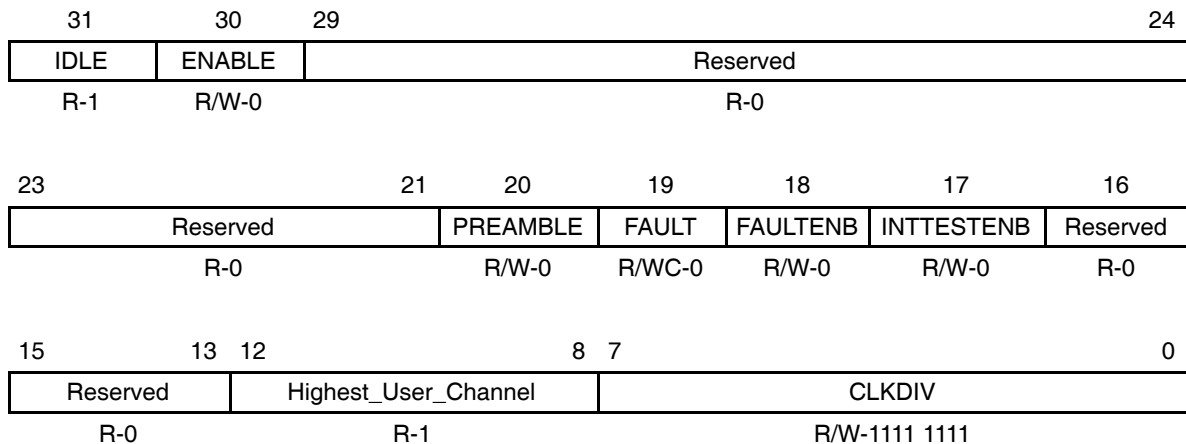

Legend: R = Read only; WC = Write to clear; R/W = Read/Write; -n = value after reset

Table B–227. MDIO Control Register (CONTROL) Field Values

Bit	field [†]	symval [†]	Value	Description
31	IDLE			MDIO state machine IDLE status bit.
		NO	0	State machine is not in the idle state.
		YES	1	State machine is in the idle state.
30	ENABLE			MDIO state machine enable control bit. If the MDIO state machine is active at the time it is disabled, it completes the current operation before halting and setting the IDLE bit. If using byte access, the ENABLE bit has to be the last bit written in this register.
		NO	0	Disables the MDIO state machine.
		YES	1	Enables the MDIO state machine.
29–21	Reserved	–	0	Reserved. The reserved bit location is always read as 0. A value written to this field has no effect.

[†] For CSL implementation, use the notation MDIO_CONTROL_field_symval

Table B–227. MDIO Control Register (CONTROL) Field Values (Continued)

Bit	field [†]	symval [†]	Value	Description
20	PREAMBLE			MDIO frame preamble disable bit.
		ENABLED	0	Standard MDIO preamble is used.
		DISABLED	1	Disables this device from sending MDIO frame preambles.
19	FAULT			Fault indicator bit. Writing a 1 to this bit clears this bit.
		NO	0	No failure.
		YES	1	The MDIO pins fail to read back what the device is driving onto them indicating a physical layer fault. The MDIO state machine is reset.
18	FAULTENB			Fault detect enable bit.
		NO	0	Disables the physical layer fault detection.
		YES	1	Enables the physical layer fault detection.
17	INTTESTENB			Interrupt test enable bit.
		NO	0	Interrupt test bits are not set.
		YES	1	Enables the host to set the USERINTRAW, USERINTMASKED, LINKINTRAW, and LINKINTMASKED register bits for test purposes.
16–13	Reserved	–	0	Reserved. The reserved bit location is always read as 0. A value written to this field has no effect.
12–8	Highest_User_Channel	–	1	Highest user-access channel bits specify the highest user-access channel that is available in the MDIO and is currently set to 1.
7–0	CLKDIV		0–FFh	Clock divider bits. Specifies the division ratio between peripheral clock and the frequency of MDCLK. MDCLK is disabled when CLKDIV is cleared to 0. MDCLK frequency = peripheral clock/(CLKDIV + 1).
			0	MDCLK is disabled.
		DEFAULT	FFh	MDCLK frequency = peripheral clock/256.

[†] For CSL implementation, use the notation MDIO_CONTROL_field_symval

B.13.3 MDIO PHY Alive Indication Register (ALIVE)

The MDIO PHY alive indication register (ALIVE) is shown in Figure B–220 and described in Table B–228.

Figure B–220. MDIO PHY Alive Indication Register (ALIVE)

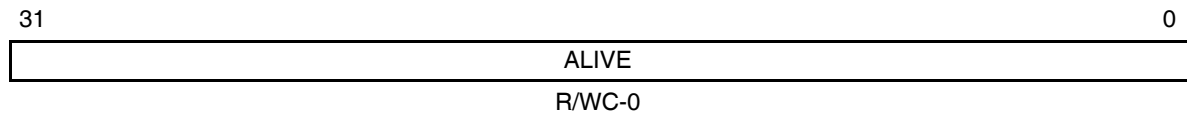

Legend: R = Read only; WC = Write 1 to clear, write of 0 has no effect; -n = value after reset

Table B–228. MDIO PHY Alive Indication Register (ALIVE) Field Values

Bit	Field	Value	Description
31–0	ALIVE		MDIO ALIVE bits. Both user and polling accesses to a PHY cause the corresponding ALIVE bit to be updated. The ALIVE bits are only meant to give an indication of the presence or not of a PHY with the corresponding address. Writing a 1 to any bit clears that bit, writing a 0 has no effect.
		0	The PHY fails to acknowledge the access.
		1	The most recent access to the PHY with an address corresponding to the register bit number was acknowledged by the PHY.

B.13.4 MDIO PHY Link Status Register (LINK)

The MDIO PHY link status register (LINK) is shown in Figure B–221 and described in Table B–229.

Figure B–221. MDIO PHY Link Status Register (LINK)

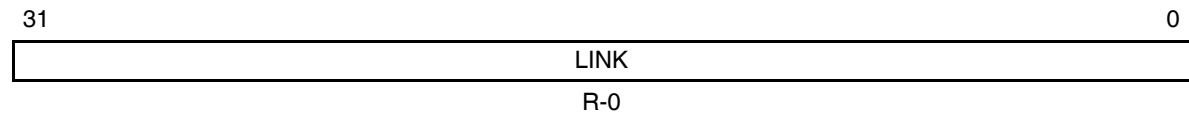

Legend: R = Read only; -n = value after reset

Table B–229. MDIO PHY Link Status Register (LINK) Field Values

Bit	Field	Value	Description
31–0	LINK		MDIO link state bits. These bits are updated after a read of the PHY generic status register. Writes to these bits have no effect.
		0	The PHY indicates it does not have a link or fails to acknowledge the read transaction.
		1	The PHY with the corresponding address has a link and the PHY acknowledges the read transaction.

B.13.5 MDIO Link Status Change Interrupt Register (LINKINTRAW)

The MDIO PHY link status change interrupt register (LINKINTRAW) is shown in Figure B–222 and described in Table B–230.

Figure B–222. MDIO Link Status Change Interrupt Register (LINKINTRAW)

31	Reserved	2	1	0
R-0		MAC1	MAC0	
		R/WC-0	R/WC-0	

Legend: R = Read only; WC = Write 1 to clear, write of 0 has no effect; -n = value after reset

Table B–230. MDIO Link Status Change Interrupt Register (LINKINTRAW) Field Values

Bit	field [†]	symval [†]	Value	Description
31–2	Reserved	–	0	Reserved. The reserved bit location is always read as 0. A value written to this field has no effect.
1	MAC1			MDIO link change event bit. Writing a 1 clears the event and writing a 0 has no effect. If the INTTESTENB bit in the MDIO control register is set to 1, the host may set the MAC1 bit to 1 for test purposes.
		NO	0	No MDIO link change event.
		YES	1	An MDIO link change event (change in the MDIO PHY link status register) corresponding to the PHY address in MDIO user PHY select register 1 (USERPHYSEL1).
0	MAC0			MDIO link change event bit. Writing a 1 clears the event and writing a 0 has no effect. If the INTTESTENB bit in the MDIO control register is set to 1, the host may set the MAC0 bit to 1 for test purposes.
		NO	0	No MDIO link change event.
		YES	1	An MDIO link change event (change in the MDIO PHY link status register) corresponding to the PHY address in MDIO user PHY select register 0 (USERPHYSEL0).

[†] For CSL implementation, use the notation MDIO_LINKINTRAW_field_symval

B.13.6 MDIO Link Status Change Interrupt (Masked) Register (LINKINTMASKED)

The MDIO PHY link status change interrupt (masked) register (LINKINTMASKED) is shown in Figure B–223 and described in Table B–231.

Figure B–223. MDIO Link Status Change Interrupt (Masked) Register (LINKINTMASKED)

31	Reserved	2	1	0
R-0		MAC1	MAC0	
		R/WC-0	R/WC-0	

Legend: R = Read only; WC = Write 1 to clear, write of 0 has no effect; -n = value after reset

Table B–231. MDIO Link Status Change Interrupt (Masked) Register (LINKINTMASKED) Field Values

Bit	field [†]	symval [†]	Value	Description
31–2	Reserved	–	0	Reserved. The reserved bit location is always read as 0. A value written to this field has no effect.
1	MAC1			MDIO link change interrupt bit. Writing a 1 clears the interrupt and writing a 0 has no effect. If the INTTESTENB bit in the MDIO control register is set to 1, the host may set the MAC1 bit to 1 for test purposes.
		NO	0	No MDIO link change event.
		YES	1	An MDIO link change event (change in the MDIO PHY link status register) corresponding to the PHY address in MDIO user PHY select register 1 (USERPHYSEL1) and the LINKINTENB bit in USERPHYSEL1 is set to 1.
0	MAC0			MDIO link change interrupt bit. Writing a 1 clears the interrupt and writing a 0 has no effect. If the INTTESTENB bit in the MDIO control register is set to 1, the host may set the MAC0 bit to 1 for test purposes.
		NO	0	No MDIO link change event.
		YES	1	An MDIO link change event (change in the MDIO PHY link status register) corresponding to the PHY address in MDIO user PHY select register 0 (USERPHYSEL0) and the LINKINTENB bit in USERPHYSEL0 is set to 1.

[†] For CSL implementation, use the notation MDIO_LINKINTMASKED_field_symval

B.13.7 MDIO User Command Complete Interrupt Register (USERINTRAW)

The MDIO user command complete interrupt register (USERINTRAW) is shown in Figure B–224 and described in Table B–232.

Figure B–224. MDIO User Command Complete Interrupt Register (USERINTRAW)

31	Reserved	2	1	0
		MAC1	MAC0	
R-0		R/WC-0	R/WC-0	

Legend: R = Read only; WC = Write 1 to clear, write of 0 has no effect; -n = value after reset

Table B–232. MDIO User Command Complete Interrupt Register (USERINTRAW)
Field Values

Bit	field†	symval†	Value	Description
31–2	Reserved	–	0	Reserved. The reserved bit location is always read as 0. A value written to this field has no effect.
1	MAC1			MDIO user command complete event bit. Writing a 1 clears the event and writing a 0 has no effect. If the INTTESTENB bit in the MDIO control register is set to 1, the host may set the MAC1 bit to 1 for test purposes.
		NO	0	No MDIO user command complete event.
		YES	1	The previously scheduled PHY read or write command using MDIO user access register 1 (USERACCESS1) has completed.
0	MAC0			MDIO user command complete event bit. Writing a 1 clears the event and writing a 0 has no effect. If the INTTESTENB bit in the MDIO control register is set to 1, the host may set the MAC0 bit to 1 for test purposes.
		NO	0	No MDIO user command complete event.
		YES	1	The previously scheduled PHY read or write command using MDIO user access register 0 (USERACCESS0) has completed.

† For CSL implementation, use the notation MDIO_USERINTRAW_field_symval

B.13.8 MDIO User Command Complete Interrupt (Masked) Register (USERINTMASKED)

The MDIO user command complete interrupt (masked) register (USERINTMASKED) is shown in Figure B–225 and described in Table B–233.

Figure B–225. MDIO User Command Complete Interrupt (Masked) Register (USERINTMASKED)

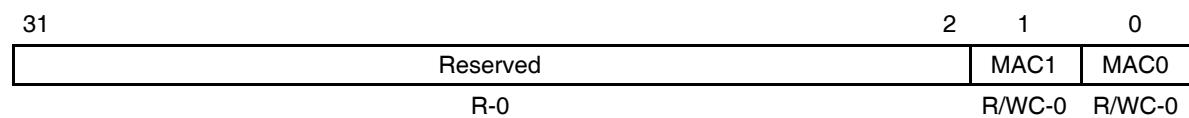

Legend: R = Read only; WC = Write 1 to clear, write of 0 has no effect; -n = value after reset

Table B–233. MDIO User Command Complete Interrupt (Masked) Register (USERINTMASKED) Field Values

Bit	field [†]	symval [†]	Value	Description
31–2	Reserved	–	0	Reserved. The reserved bit location is always read as 0. A value written to this field has no effect.
1	MAC1			MDIO user command complete interrupt bit. Writing a 1 clears the interrupt and writing a 0 has no effect. If the INTTESTENB bit in the MDIO control register is set to 1, the host may set the MAC1 bit to 1 for test purposes.
		NO	0	No MDIO user command complete event.
		YES	1	The previously scheduled PHY read or write command using MDIO user access register 1 (USERACCESS1) has completed and the MAC1 bit in USERINTMASKSET is set to 1.
0	MAC0			MDIO user command complete interrupt bit. Writing a 1 clears the interrupt and writing a 0 has no effect. If the INTTESTENB bit in the MDIO control register is set to 1, the host may set the MAC0 bit to 1 for test purposes.
		NO	0	No MDIO user command complete event.
		YES	1	The previously scheduled PHY read or write command using MDIO user access register 0 (USERACCESS0) has completed and the MAC0 bit in USERINTMASKSET is set to 1.

[†] For CSL implementation, use the notation MDIO_USERINTMASKED_field_symval

B.13.9 MDIO User Command Complete Interrupt Mask Set Register (USERINTMASKSET)

The MDIO user command complete interrupt mask set register (USERINTMASKSET) is shown in Figure B-226 and described in Table B-234.

Figure B-226. MDIO User Command Complete Interrupt Mask Set Register (USERINTMASKSET)

31	Reserved	2	1	0
	R-0		MAC1 R/WS-0	MAC0 R/WS-0

Legend: R = Read only; WS = Write 1 to set, write of 0 has no effect; -n = value after reset

Table B-234. MDIO User Command Complete Interrupt Mask Set Register (USERINTMASKSET) Field Values

Bit	field [†]	symval [†]	Value	Description
31-2	Reserved	-	0	Reserved. The reserved bit location is always read as 0. A value written to this field has no effect.
1	MAC1			MDIO user command complete interrupt mask set bit for MAC1 in USERINTMASKED. Writing a 1 sets the bit and writing a 0 has no effect.
		NO	0	MDIO user command complete interrupts for the MDIO user access register 1 (USERACCESS1) are disabled.
		YES	1	MDIO user command complete interrupts for the MDIO user access register 1 (USERACCESS1) are enabled.
0	MAC0			MDIO user command complete interrupt mask set bit for MAC0 in USERINTMASKED. Writing a 1 sets the bit and writing a 0 has no effect.
		NO	0	MDIO user command complete interrupts for the MDIO user access register 0 (USERACCESS0) are disabled.
		YES	1	MDIO user command complete interrupts for the MDIO user access register 0 (USERACCESS0) are enabled.

[†] For CSL implementation, use the notation MDIO_USERINTMASKSET_field_symval

B.13.10 MDIO User Command Complete Interrupt Mask Clear Register (USERINTMASKCLEAR)

The MDIO user command complete interrupt mask clear register (USERINTMASKCLEAR) is shown in Figure B–227 and described in Table B–235.

Figure B–227. MDIO User Command Complete Interrupt Mask Clear Register (USERINTMASKCLEAR)

31	Reserved	2	1	0
	R-0		R/WC-0	R/WC-0

Legend: R = Read only; WC = Write 1 to clear, write of 0 has no effect; -n = value after reset

Table B–235. MDIO User Command Complete Interrupt Mask Clear Register (USERINTMASKCLEAR) Field Values

Bit	field†	symval†	Value	Description
31–2	Reserved	–	0	Reserved. The reserved bit location is always read as 0. A value written to this field has no effect.
1	MAC1			MDIO user command complete interrupt mask clear bit for MAC1 in USERINTMASKED. Writing a 1 clears the bit and writing a 0 has no effect.
		NO	0	MDIO user command complete interrupts for the MDIO user access register 1 (USERACCESS1) are enabled.
		YES	1	MDIO user command complete interrupts for the MDIO user access register 1 (USERACCESS1) are disabled.
0	MAC0			MDIO user command complete interrupt mask clear bit for MAC0 in USERINTMASKED. Writing a 1 clears the bit and writing a 0 has no effect.
		NO	0	MDIO user command complete interrupts for the MDIO user access register 0 (USERACCESS0) are enabled.
		YES	1	MDIO user command complete interrupts for the MDIO user access register 0 (USERACCESS0) are disabled.

† For CSL implementation, use the notation MDIO_USERINTMASKCLEAR_field_symval

B.13.11 MDIO User Access Register 0 (USERACCESS0)

The MDIO user access register 0 (USERACCESS0) is shown in Figure B–228 and described in Table B–236.

Figure B–228. MDIO User Access Register 0 (USERACCESS0)

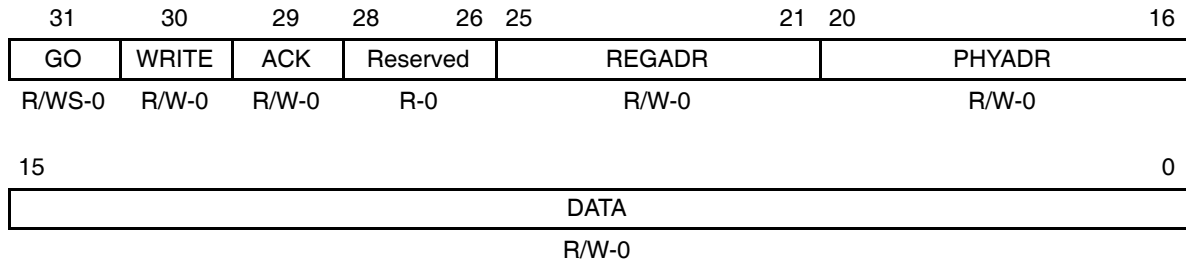

Legend: R = Read only; R/W = Read/Write; WS = Write 1 to set, write of 0 has no effect; -n = value after reset

Table B–236. MDIO User Access Register 0 (USERACCESS0) Field Values

Bit	field [†]	symval [†]	Value	Description
31	GO			GO bit is writable only if the MDIO state machine is enabled (ENABLE bit in MDIO control register is set to 1). If byte access is being used, the GO bit should be written last. Writing a 1 sets the bit and writing a 0 has no effect.
		DEFAULT	0	No effect. The GO bit clears when the requested access has been completed.
			1	The MDIO state machine performs an MDIO access when it is convenient, this is not an instantaneous process. Any writes to USERACCESS0 are blocked.
30	WRITE			Write enable bit determines the MDIO transaction type.
		DEFAULT	0	MDIO transaction is a register read.
			1	MDIO transaction is a register write.
29	ACK			Acknowledge bit determines if the PHY acknowledges the read transaction.
		DEFAULT	0	No acknowledge.
			1	PHY acknowledges the read transaction.
28–26	Reserved	–	0	Reserved. The reserved bit location is always read as 0. A value written to this field has no effect.

[†] For CSL implementation, use the notation MDIO_USERACCESS0_field_symval

Table B–236. MDIO User Access Register 0 (USERACCESS0) Field Values (Continued)

Bit	field [†]	symval [†]	Value	Description
25–21	REGADR		0–1Fh	Register address bits specify the PHY register to be accessed for this transaction.
20–16	PHYADR		0–1Fh	PHY address bits specify the PHY to be accessed for this transaction.
15–0	DATA		0–FFFFh	User data bits specify the data value read from or to be written to the specified PHY register.

[†] For CSL implementation, use the notation MDIO_USERACCESS0_field_symval

B.13.12 MDIO User Access Register 1 (USERACCESS1)

The MDIO user access register 1 (USERACCESS1) is shown in Figure B–229 and described in Table B–237.

Figure B–229. MDIO User Access Register 1 (USERACCESS1)

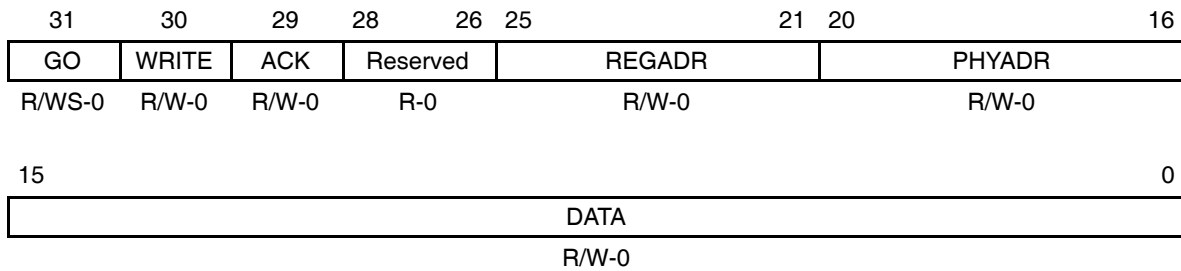

Legend: R = Read only; R/W = Read/Write; WS = Write 1 to set, write of 0 has no effect; -n = value after reset

Table B–237. MDIO User Access Register 1 (USERACCESS1) Field Values

Bit	field [†]	symval [†]	Value	Description
31	GO			GO bit is writable only if the MDIO state machine is enabled (ENABLE bit in MDIO control register is set to 1). If byte access is being used, the GO bit should be written last. Writing a 1 sets the bit and writing a 0 has no effect.
		DEFAULT	0	No effect. The GO bit clears when the requested access has been completed.
			1	The MDIO state machine performs an MDIO access when it is convenient, this is not an instantaneous process. Any writes to USERACCESS1 are blocked.
30	WRITE			Write enable bit determines the MDIO transaction type.
		DEFAULT	0	MDIO transaction is a register read.
			1	MDIO transaction is a register write.
29	ACK			Acknowledge bit determines if the PHY acknowledges the read transaction.
		DEFAULT	0	No acknowledge.
			1	PHY acknowledges the read transaction.
28–26	Reserved	–	0	Reserved. The reserved bit location is always read as 0. A value written to this field has no effect.
25–21	REGADR		0–1Fh	Register address bits specify the PHY register to be accessed for this transaction.
20–16	PHYADR		0–1Fh	PHY address bits specify the PHY to be accessed for this transaction.
15–0	DATA		0–FFFFh	User data bits specify the data value read from or to be written to the specified PHY register.

[†] For CSL implementation, use the notation MDIO_USERACCESS1_field_symval

B.13.13 MDIO User PHY Select Register 0 (USERPHYSEL0)

The MDIO user PHY select register 0 (USERPHYSEL0) is shown in Figure B–230 and described in Table B–238.

Figure B–230. MDIO User PHY Select Register 0 (USERPHYSEL0)

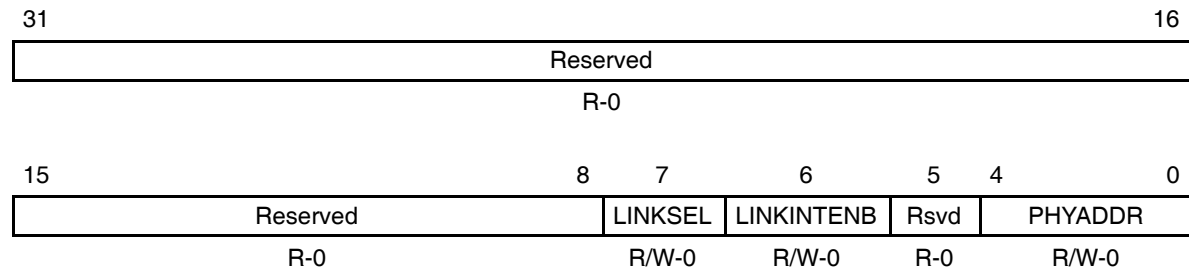

Legend: R = Read only; R/W = Read/Write; -n = value after reset

Table B–238. MDIO User PHY Select Register 0 (USERPHYSEL0) Field Values

Bit	field [†]	symval [†]	Value	Description
31–8	Reserved	–	0	Reserved. The reserved bit location is always read as 0. A value written to this field has no effect.
7	LINKSEL			Link status determination select bit.
		MDIO	0	Link status is determined by the MDIO state machine.
		MLINK	1	Value must be set to MDIO.
6	LINKINTENB			Link change interrupt enable bit.
		DISABLE	0	Link change interrupts are disabled.
		ENABLE	1	Link change status interrupts for PHY address specified in PHYADDR bits are enabled.
5	Reserved	–	0	Reserved. The reserved bit location is always read as 0. A value written to this field has no effect.
4–0	PHYADDR		0–1Fh	PHY address bits specify the PHY address to be monitored.

[†] For CSL implementation, use the notation MDIO_USERPHYSEL0_field_symval

B.13.14 MDIO User PHY Select Register 1 (USERPHYSEL1)

The MDIO user PHY select register 1 (USERPHYSEL1) is shown in Figure B–231 and described in Table B–239.

Figure B–231. MDIO User PHY Select Register 1 (USERPHYSEL1)

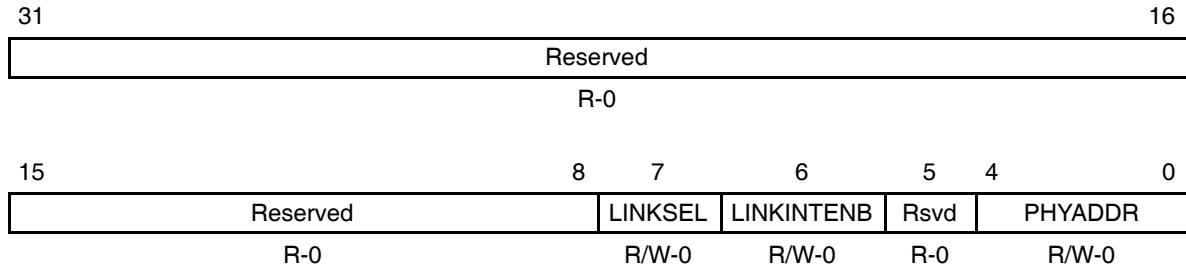

Legend: R = Read only; R/W = Read/Write; -n = value after reset

Table B–239. MDIO User PHY Select Register 1 (USERPHYSEL1) Field Values

Bit	field [†]	symval [†]	Value	Description
31–8	Reserved	–	0	Reserved. The reserved bit location is always read as 0. A value written to this field has no effect.
7	LINKSEL			Link status determination select bit.
		MDIO	0	Link status is determined by the MDIO state machine.
		MLINK	1	Value must be set to MDIO.
6	LINKINTENB			Link change interrupt enable bit.
		DISABLE	0	Link change interrupts are disabled.
		ENABLE	1	Link change status interrupts for PHY address specified in PHYADDR bits are enabled.
5	Reserved	–	0	Reserved. The reserved bit location is always read as 0. A value written to this field has no effect.
4–0	PHYADDR		0–1Fh	PHY address bits specify the PHY address to be monitored.

[†] For CSL implementation, use the notation MDIO_USERPHYSEL1_field_symval

B.14 Peripheral Component Interconnect (PCI) Registers

Table B–240. PCI Memory-Mapped Registers

Acronym	Register Name	Section
RSTSRC	DSP reset source/status register	B.14.1
PMDCSR†	Power management DSP control/status register	B.14.2
PCIIS	PCI interrupt source register	B.14.3
PCIEN	PCI interrupt enable register	B.14.4
DSPMA	DSP master address register	B.14.5
PCIMA	PCI master address register	B.14.6
PCIMC	PCI master control register	B.14.7
CDSPA	Current DSP address register	B.14.8
CPCIA	Current PCI address register	B.14.9
CCNT	Current byte count register	B.14.10
EEADD	EEPROM address register	B.14.11
EEDAT	EEPROM data register	B.14.12
EECTL	EEPROM control register	B.14.13
HALT1	PCI transfer halt register	B.14.14
TRCTL‡	PCI transfer request control register	B.14.15

† This register only applies to C62x/C67x DSP.

‡ TRCTL register only applies to C64x DSP.

B.14.1 DSP Reset Source/Status Register (RSTSRC)

The DSP reset source/status register (RSTSRC) shows the reset status of the DSP. It gives the DSP visibility to which reset source caused the last reset. The RSTSRC is shown in Figure B–232 and described in Table B–241. The RST, PRST, and WARMRST bits are cleared by a read of RSTSRC.

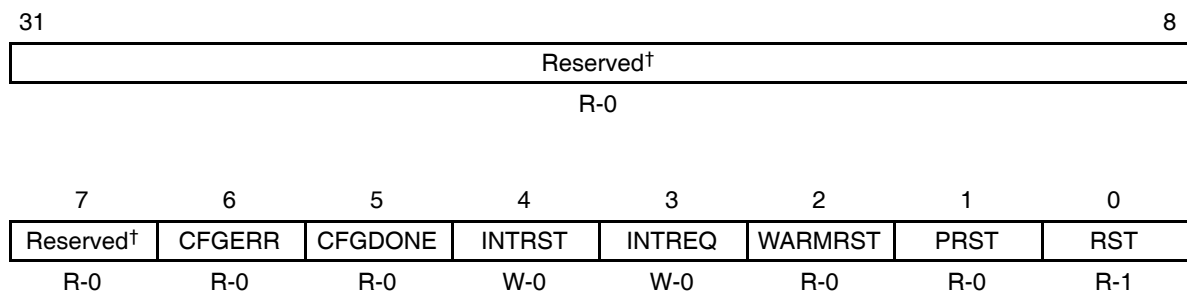
Figure B–232. DSP Reset Source/Status Register (RSTSRC)

Legend: R = Read only; W = Write only; -*n* = value after reset

† If writing to this field, always write the default value for future device compatibility.

Table B–241. DSP Reset Source/Status Register (RSTSRC) Field Values

Bits	field†	symval†	Value	Description
31–7	Reserved	–	0	Reserved. The reserved bit location always returns the default value. A value written to this field has no effect. If writing to this field, always write the default value for future device compatibility.
6	CFGERR	OF(<i>value</i>)	0	Configuration error bit. An error occurred when trying to load the configuration registers from EEPROM (Checksum failure). Read-only bit, writes have no effect.
			1	Checksum error during EEPROM autoinitialization.
5	CFGDONE	OF(<i>value</i>)	0	Configuration hold bit. EEPROM has finished loading the PCI configuration registers. Read-only bit, writes have no effect.
			1	Configuration registers load from EEPROM is complete.

† For CSL implementation, use the notation `PCI_RSTSRC_field_symval`

Table B–241. DSP Reset Source/Status Register (RSTSRC) Field Values (Continued)

Bits	field [†]	symval [†]	Value	Description
4	INTRST			PINTA reset bit. This bit must be asserted before another host interrupt can be generated. Write-only bit, reads return 0.
		NO	0	Writes of 0 have no effect.
		YES	1	When a 1 is written to this bit, PINTA is deasserted and the interrupt logic is reset to enable future interrupts.
3	INTREQ			Request a DSP-to-PCI interrupt when written with a 1. Write-only bit, reads return 0.
		NO	0	Writes of 0 have no effect.
		YES	1	Causes assertion of PINTA if the INTAM bit in the host status register (HSR) is 0.
2	WARMRST	OF(value)		A host software reset of the DSP or a power management warm reset occurred since the last RSTSRC read or last RESET. Read-only bit, writes have no effect.
			0	No warm reset since last RSTSRC read or RESET.
			1	Warm reset since last RSTSRC read or RESET.
1	PRST	OF(value)		Indicates occurrence of a PRST reset since the last RSTSRC read or RESET assertion. Read-only bit, writes have no effect.
			0	No PRST reset since last RSTSRC read.
			1	PRST reset has occurred since last RSTSRC read.
0	RST	OF(value)		Indicates a device reset (RESET) occurred since the last RSTSRC read. Read-only bit, writes have no effect.
			0	No device reset (RESET) since last RSTSRC read
			1	Device reset (RESET) has occurred since last RSTSRC read

[†] For CSL implementation, use the notation PCI_RSTSRC_field_symval

B.14.2 Power Management DSP Control/Status Register (PMDCSR) (C62x/C67x)

The power management DSP control/status register (PMDCSR) allows power management control. The PMDCSR is shown in Figure B–233 and described in Table B–242.

B.14.2.1 3.3 V_{aux} Presence Detect Status Bit (AUXDETECT)

The 3.3 V_{aux}DET pin is used to indicate the presence of 3.3 V_{aux} when V_{DDcore} is removed. The DSP can monitor this pin by reading the AUXDETECT bit in PMDCSR. The PMEEN bit in the power management control/status register (PMCSR) is held clear by the 3.3 V_{aux}DET pin being low.

B.14.2.2 PCI Port Response to $\overline{\text{PWR_WKP}}$ and PME Generation

The PCI port responds differently to an active $\overline{\text{PWR_WKP}}$ input, depending on whether V_{DDcore} is alive when 3.3 V_{aux} is alive. The PCI port response to $\overline{\text{PWR_WKP}}$ is powered by 3.3 V_{aux}.

When V_{DDcore} is alive and 3.3 V_{aux} is alive (that is, all device power states but D3_{cold}), bits are set in the PCI interrupt source register (PCIIS) for the detection of the $\overline{\text{PWR_WKP}}$ high-to-low and low-to-high transition. The $\overline{\text{PWR_WKP}}$ signal is directly connected to the DSP PCI_WAKEUP interrupt.

When V_{DDcore} is shut down and 3.3 V_{aux} is alive (in D3_{cold}), a $\overline{\text{PWR_WKP}}$ transition causes the PMESTAT bit in PMCSR to be set (regardless of the PMEEN bit value). If the PMEEN bit is set, $\overline{\text{PWR_WKP}}$ activity also causes the PME pin to be asserted and held active.

The PCI port can also generate PME depending on the HWPMECTL bits in PMDCSR. PME can be generated from any state or on transition to any state on an active $\overline{\text{PWR_WKP}}$ signal, if the corresponding bit in the HWPMECTL bits is set.

Transitions on the $\overline{\text{PWR_WKP}}$ pin can cause a CPU interrupt (PCI_WAKEUP). The PWRHL and PWRLH bits in PCIIS indicate a high-to-low or low-to-high transition on the $\overline{\text{PWR_WKP}}$ pin. If the corresponding interrupts are enabled in the PCI interrupt enable register (PCIEN), a PCI_WAKEUP interrupt is generated to the CPU.

If 3.3 V_{aux} is not powered, the PME pin is in a high-impedance state. Once PME is driven active by the DSP, it is only deasserted when the PMESTAT bit in PMCSR is written with a 1 or the PMEEN bit is written with a 0. Neither $\overline{\text{PRST}}$, $\overline{\text{RESET}}$, or warm reset active can cause PME to go into a high-impedance state if it was already asserted before the reset.

Figure B–233. Power Management DSP Control/Status Register (PMDCSR)

31	19	18	11	10	9	8	
Reserved [†]	HWPMECTL		D3WARMONWKP	D2WARMONWKP	PMEEN		
R-0	R/W-1000 1000		R-x	R-x	R/W-x		
7	6	5	4	3	2	1	0
PWRWKP	PMESTAT	PMEDRVN	AUXDETECT	CURSTATE	REQSTATE		
R-x	R-x/W-0	R-0	R-x	R/W-0	R-0		

Legend: R = Read only; R/W = Read/Write; -n = value after reset; -x = value is indeterminate after reset

[†] If writing to this field, always write the default value for future device compatibility.

Table B–242. Power Management DSP Control/Status Register (PMDCSR)
Field Values

Bits	field [†]	symval [†]	Value	Description
31–19	Reserved	–	0	Reserved. The reserved bit location always returns the default value. A value written to this field has no effect. If writing to this field, always write the default value for future device compatibility.
18–11	HWPMECTL	–	0–FFh	Hardware PME control. Allows PME to be generated automatically by hardware on active PWR_WKP if the corresponding bit is set.
		–	0	Reserved
		REQD0	1h	Requested state = 00
		REQD1	2h	Requested state = 01
		REQD2	3h	Requested state = 10
		REQD3	4h	Requested state = 11
		–	5h–FFh	Reserved

[†] For CSL implementation, use the notation PCI_PMDCSR_field_symval

Table B–242. Power Management DSP Control/Status Register (PMDCSR)
Field Values (Continued)

Bits	field [†]	symval [†]	Value	Description
10	D3WARMONWKP	OF(value)		Warm reset from D3. Read-only bit, writes have no effect. Warm resets are only generated from $\overline{\text{PWR_WKP}}$ if the following conditions are true: <ul style="list-style-type: none"> • $\overline{\text{PRST}}$ (PCI reset) is deasserted • PCLK is active.
			0	No warm reset is generated on $\overline{\text{PWR_WKP}}$ asserted (low).
			1	Warm reset is generated on $\overline{\text{PWR_WKP}}$ asserted if the current state is D3.
9	D2WARMONWKP	OF(value)		Warm reset from D2. Read-only bit, writes have no effect. Warm resets are only generated from $\overline{\text{PWR_WKP}}$ if the following conditions are true: <ul style="list-style-type: none"> • $\overline{\text{PRST}}$ (PCI reset) is deasserted • PCLK is active.
			0	No warm reset is generated on $\overline{\text{PWR_WKP}}$ asserted (low).
			1	Warm reset is generated on $\overline{\text{PWR_WKP}}$ asserted if the current state is D2.
8	PMEEN			PME assertion enable bit. Reads return current value of PMEEN bit in the power management control/status register (PMCSR). Writes of 1 clear both the PMEEN and PMESTAT bits in PMCSR, writes of 0 have no effect.
		0	PMEEN bit in PMCSR is 0; PME assertion is disabled.	
		CLR	1	PMEEN bit in PMCSR is 1; PME assertion is enabled.
7	PWRWKP	OF(value)		$\overline{\text{PWRWKP}}$ pin value. Read-only bit, writes have no effect.
			0	$\overline{\text{PWR_WKP}}$ pin is low.
			1	$\overline{\text{PWR_WKP}}$ pin is high.

[†] For CSL implementation, use the notation `PCI_PMDCSR_field_symval`

Table B–242. Power Management DSP Control/Status Register (PMDCSR)
Field Values (Continued)

Bits	field [†]	symval [†]	Value	Description	
6	PMESTAT			PMESTAT sticky bit value. Reads return the current status of the PMESTAT bit in the power management control/status register (PMCSR). If the PMESTAT and PMEEN bits are written with a 1 at the same time, the PMEEN and PMESTAT bits are cleared. Writes of 0 have no effect.	
			0	No effect.	
5	PMEDRVN	OF(value)	SET	Forces the PMESTAT bit in PMCSR to 1.	
			0	DSP read of PMDCSR, but bit would be set if the PMEEN and PMESTAT bits are both still high.	
			1	PMEEN and PMESTAT bits in the power management control/status register (PMCSR) are high.	
4	AUXDETECT	OF(value)		3.3V _{aux} DET pin value. Read-only bit, writes have no effect.	
			0	3.3 V _{aux} DET is low.	
			1	3.3 V _{aux} DET is high.	
3–2	CURSTATE		0–3h	Current power state. Reflects the current power management state of the device. On changing state, the device must change the CURSTATE bits. The value written here is used for PCI reads of the PWRSTATE bits in the power management control/status register (PMCSR).	
			D0	0	Current state = 00
			D1	1h	Current state = 01
			D2	2h	Current state = 10
			D3	3h	Current state = 11
1–0	REQSTATE	OF(value)	0–3h	Last requested power state. Last value written by the host to the PCI PWRSTATE bits in the power management control/status register (PMCSR). Cleared to 00b on RESET or PRST. Read-only bit, writes have no effect.	

† For CSL implementation, use the notation PCI_PMDCSR_field_symval

B.14.3 PCI Interrupt Source Register (PCIIS)

The PCI interrupt source register (PCIIS) shows the status of the interrupt sources. Writing a 1 to the bit(s) clears the condition. Writes of 0 to, and reads from, the bit(s) have no effect. The PCIIS is shown in Figure B–234 and described in Table B–243.

Figure B–234. PCI Interrupt Source Register (PCIIS)

31	Reserved†						16	
R-0								
15	Reserved†		13	12	11	10	9	8
R-0		DMAHALTED‡	PRST	Reserved†	EERDY	CFGERR		
R/W-0		R/W-0	R/W-0	R-0	R/W-0	R/W-0		
7	6	5	4	3	2	1	0	
CFGDONE	MASTEROK	PWRHL	PWRLH	HOSTSW	PCIMASTER	PCITARGET	PWRMGMT	
R/W-0	R/W-0	R/W-0	R/W-0	R/W-0	R/W-0	R/W-0	R/W-0	

Legend: R = Read only; R/W = Read/Write; -n = value after reset

† If writing to this field, always write the default value for future device compatibility.

‡ This bit is reserved on C64x DSP.

Table B–243. PCI Interrupt Source Register (PCIIS) Field Values

Bit	field†	symval†	Value	Description
31–13	Reserved	–	0	Reserved. The reserved bit location always returns the default value. A value written to this field has no effect. If writing to this field, always write the default value for future device compatibility.
12	DMAHALTED	CLR	0	Auxiliary DMA transfers are not halted.
			1	Auxiliary DMA transfers have stopped.
11	PRST	NOCHG	0	No change of state on PCI reset.
			1	PCI reset changed state.

† For CSL implementation, use the notation `PCI_PCIIS_field_symval`

Table B–243. PCI Interrupt Source Register (PCIIS) Field Values (Continued)

Bit	field [†]	symval [†]	Value	Description
10	Reserved	–	0	Reserved. The reserved bit location always returns the default value. A value written to this field has no effect. If writing to this field, always write the default value for future device compatibility.
9	EERDY	CLR	0	EEPROM ready bit. EEPROM is not ready to accept a new command.
			1	EEPROM is ready to accept a new command and the data register can be read.
8	CFGERR	CLR	0	Configuration error bit. No checksum failure during PCI autoinitialization.
			1	Checksum failed during PCI autoinitialization. Set after an initialization due to $\overline{\text{PRST}}$ asserted and checksum error. Set after WARM if initialization has been done, but had checksum error.
7	CFGDONE	CLR	0	Configuration hold bit. Configuration of PCI configuration registers is not complete.
			1	Configuration of PCI configuration registers is complete. Set after an initialization due to $\overline{\text{PRST}}$ asserted. Set after WARM if initialization has been done.
6	MASTEROK	CLR	0	PCI master transaction completes bit. No PCI master transaction completes interrupt.
			1	PCI master transaction completes interrupt.
5	PWRHL	CLR	0	High-to-low transition on PWRWKP bit. No high-to-low transition on PWRWKP.
			1	High-to-low transition on PWRWKP.
4	PWRLH	CLR	0	Low-to-high transition on PWRWKP bit. No low-to-high transition on PWRWKP.
			1	Low-to-high transition on PWRWKP.

[†] For CSL implementation, use the notation `PCI_PCIIS_field_symval`

Table B–243. PCI Interrupt Source Register (PCIIS) Field Values (Continued)

Bit	field [†]	symval [†]	Value	Description
3	HOSTSW			Host software requested bit.
			0	No host software requested interrupt.
		CLR	1	Host software requested interrupt (this bit must be set after boot from PCI to wake up DSP).
2	PCIMASTER			Master abort received bit.
			0	No master abort received.
		CLR	1	Master abort received.
1	PCITARGET			Target abort received bit.
			0	No target abort received.
		CLR	1	Target abort received.
0	PWRMGMT			Power management state transition bit.
			0	No power management state transition interrupt.
		CLR	1	Power management state transition interrupt (is not set if the DSP clocks are not running).

[†] For CSL implementation, use the notation `PCI_PCIIS_field_symval`

B.14.4 PCI Interrupt Enable Register (PCIEN)

The PCI interrupt enable register (PCIEN) enables the PCI interrupts. For the DSP to monitor the interrupts, the DSP software must also set the appropriate bits in the CPU control status register (CSR) and CPU interrupt enable register (IER).

The only interrupt enabled after device reset ($\overline{\text{RESET}}$) is the HOSTSW interrupt. In this way, the PCI host can wake up the DSP by writing the DSPINT bit in the host-to-DSP control register (HDCR). The PCIEN is shown in Figure B–235 and described in Table B–244.

Figure B–235. PCI Interrupt Enable Register (PCIEN)

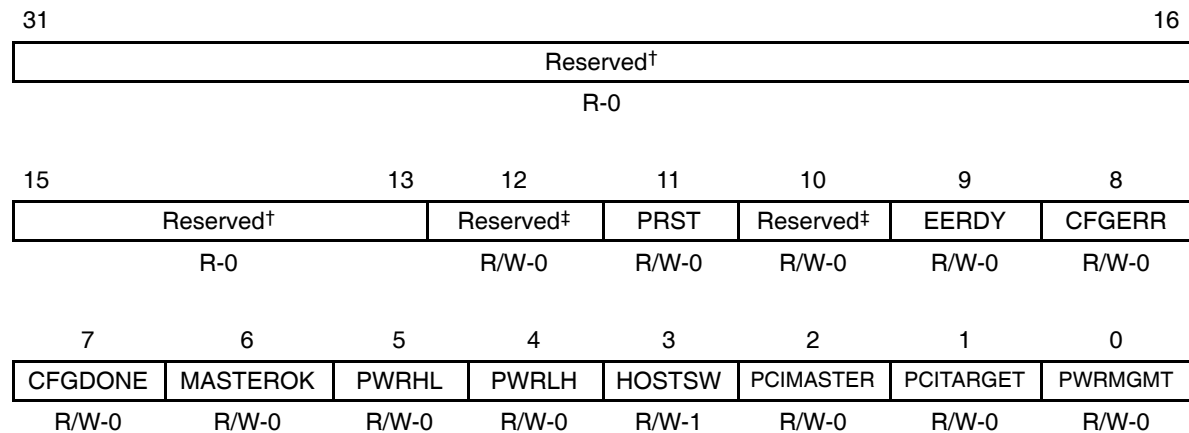

Legend: R = Read only; R/W = Read/Write; -n = value after reset

[†] If writing to this field, always write the default value for future device compatibility.

[‡] These reserved bits must always be written with 0, writing 1 to these bits result in an undefined operation.

Table B–244. PCI Interrupt Enable Register (PCIEN) Field Values

Bit	field [†]	symval [†]	Value	Description
31–13	Reserved	–	0	Reserved. The reserved bit location always returns the default value. A value written to this field has no effect. If writing to this field, always write the default value for future device compatibility.
12	Reserved	–	0	Reserved. The reserved bit location is always read as 0. This reserved bit must always be written with a 0. Writing 1 to this bit results in an undefined operation.

[†] For CSL implementation, use the notation `PCI_PCIEN_field_symval`

Table B–244. PCI Interrupt Enable Register (PCIEN) Field Values (Continued)

Bit	field [†]	symval [†]	Value	Description
11	PRST			PRST transition interrupts enable bit.
		DISABLE	0	$\overline{\text{PRST}}$ transition interrupts are not enabled.
		ENABLE	1	$\overline{\text{PRST}}$ transition interrupts are enabled.
10	Reserved	–	0	Reserved. The reserved bit location is always read as 0. This reserved bit must always be written with a 0. Writing 1 to this bit results in an undefined operation.
9	EERDY			EEPROM ready interrupts enable bit.
		DISABLE	0	EEPROM ready interrupts are not enabled.
		ENABLE	1	EEPROM ready interrupts are enabled.
8	CFGERR			Configuration error interrupts enable bit.
		DISABLE	0	Configuration error interrupts are not enabled.
		ENABLE	1	Configuration error interrupts are enabled.
7	CFGDONE			Configuration complete interrupts enable bit.
		DISABLE	0	Configuration complete interrupts are not enabled.
		ENABLE	1	Configuration complete interrupts are enabled.
6	MASTEROK			PCI master transaction complete interrupts enable bit.
		DISABLE	0	PCI master transaction complete interrupts are not enabled.
		ENABLE	1	PCI master transaction complete interrupts are enabled.
5	PWRHL			High-to-low PWRWKP interrupts enable bit.
		DISABLE	0	High-to-low PWRWKP interrupts are not enabled.
		ENABLE	1	High-to-low PWRWKP interrupts are enabled.
4	PWRLH			Low-to-high PWRKWP interrupts enable bit.
		DISABLE	0	Low-to-high PWRWKP interrupts are not enabled.
		ENABLE	1	Low-to-high PWRKWP interrupts are enabled.

[†] For CSL implementation, use the notation PCI_PCIEN_field_symval

Table B–244. PCI Interrupt Enable Register (PCIEN) Field Values (Continued)

Bit	field [†]	symval [†]	Value	Description
3	HOSTSW			Host software requested interrupt enable bit.
		DISABLE	0	Host software requested interrupts are not enabled.
		ENABLE	1	Host software requested interrupt are enabled.
2	PCIMASTER			PCI master abort interrupt enable bit.
		DISABLE	0	PCI master abort interrupt is not enabled.
		ENABLE	1	PCI master abort interrupt is enabled.
1	PCITARGET			PCI target abort interrupt enable bit.
		DISABLE	0	PCI target abort interrupt is not enabled.
		ENABLE	1	PCI target abort interrupt is enabled.
0	PWRMGMT			Power management state transition interrupt enable bit.
		DISABLE	0	Power management state transition interrupt is not enabled.
		ENABLE	1	Power management state transition interrupt is enabled.

[†] For CSL implementation, use the notation `PCI_PCIEN_field_symval`

B.14.5 DSP Master Address Register (DSPMA)

The DSP master address register (DSPMA) contains the DSP address location of the destination data for DSP master reads, or the address location of source data for DSP master writes. DSPMA also contains bits to control the address modification. DSPMA is doubleword aligned on the C64x DSP and word aligned on the C6205 DSP. The DSPMA is shown in Figure B–236 and described in Table B–245.

Figure B–236. DSP Master Address Register (DSPMA)

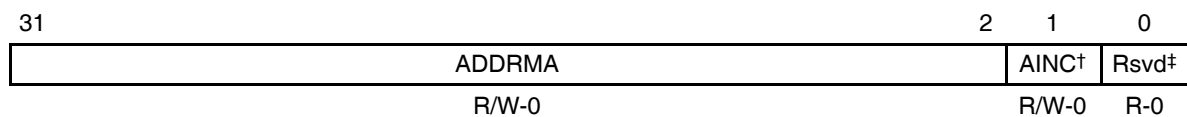

Legend: R = Read only; R/W = Read/Write; -n = value after reset

[†] This bit is valid on C6205 DSP only; on C64x DSP, this bit is reserved and must be written with a 0.

[‡] If writing to this field, always write the default value for future device compatibility.

Table B–245. DSP Master Address Register (DSPMA) Field Values

Bit	field [†]	symval [†]	Value	Description
31–2	ADDRMA	OF(<i>value</i>)	0–3FFF FFFFh	DSP word address for PCI master transactions.
1	AINC			Autoincrement mode of DSP master address (C6205 DSP only). Autoincrement only affects the lower 24 bits of DSPMA. As a result, autoincrement does not cross 16M-byte boundaries and wraps around if incrementing past the boundary. On the C64x DSP, this bit is reserved and must be written with a 0. The PCI port on the C64x DSP does not support fixed addressing for master PCI transfers. All transfers are issued to linear incrementing addresses in DSP memory.
		DISABLE	0	ADDRMA autoincrement is disabled.
		ENABLE	1	ADDRMA autoincrement is enabled.
0	Reserved	–	0	Reserved. The reserved bit location always returns the default value. A value written to this field has no effect. If writing to this field, always write the default value for future device compatibility.

[†] For CSL implementation, use the notation `PCI_DSPMA_field_symval`

B.14.6 PCI Master Address Register (PCIMA)

The PCI master address register (PCIMA) contains the PCI word address. For DSP master reads, PCIMA contains the source address; for DSP master writes, PCIMA contains the destination address. The PCIMA is shown in Figure B–237 and described in Table B–246.

Figure B–237. PCI Master Address Register (PCIMA)

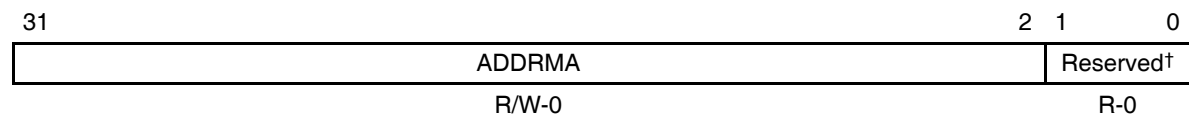

Legend: R = Read only; R/W = Read/Write; -n = value after reset

† If writing to this field, always write the default value for future device compatibility.

Table B–246. PCI Master Address Register (PCIMA) Field Values

Bit	Field	<i>symval</i> †	Value	Description
31–2	ADDRMA	OF(<i>value</i>)	0–3FFF FFFFh	PCI word address for PCI master transactions.
1–0	Reserved	–	0	Reserved. The reserved bit location always returns the default value. A value written to this field has no effect. If writing to this field, always write the default value for future device compatibility.

† For CSL implementation, use the notation `PCI_PCIMA_ADDRMA_`*symval*

B.14.7 PCI Master Control Register (PCIMC)

The PCI master control register (PCIMC) contains:

- Start bits to initiate the transfer between the DSP and PCI.
- The transfer count, which specifies the number of bytes to transfer (65K bytes maximum).
- Reads indicate transfer status

The PCIMC is shown in Figure B–238 and described in Table B–247.

Figure B–238. PCI Master Control Register (PCIMC)

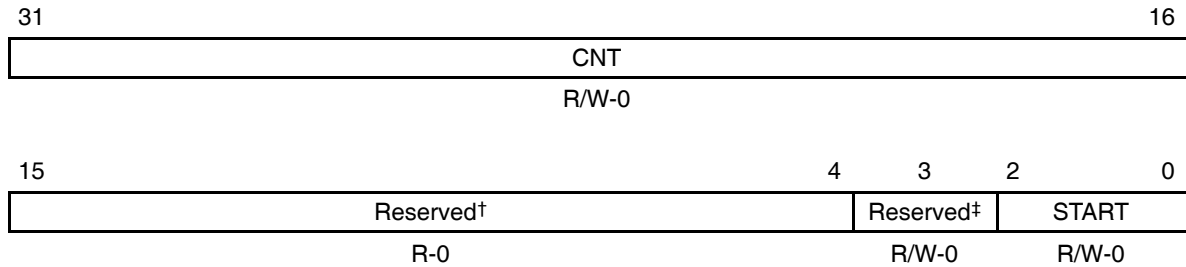

Legend: R = Read only; R/W = Read/Write; -n = value after reset

[†] If writing to this field, always write the default value for future device compatibility.

[‡] This reserved bit must always be written with 0, writing 1 to this bit results in an undefined operation.

Table B–247. PCI Master Control Register (PCIMC) Field Values

Bit	field [†]	symval [†]	Value	Description
31–16	CNT	OF(value)	0–FFFFh	Transfer count specifies the number of bytes to transfer.
15–4	Reserved	–	0	Reserved. The reserved bit location always returns the default value. A value written to this field has no effect. If writing to this field, always write the default value for future device compatibility.
3	Reserved	–	0	Reserved. The reserved bit location is always read as 0. This reserved bit must always be written with a 0. Writing 1 to this bit results in an undefined operation.
2–0	START		0–7h	Start the read or write master transaction. The START bits return to 000b when the transaction is complete. The START bits must not be written/changed during an active master transfer. If the PCI bus is reset during a transfer, the transfer stops and the FIFOs are flushed. (A CPU interrupt can be generated on a PRST transition.) The START bits only get set if the CNT bits are not 0000h.
		FLUSH	0	Transaction not started/flush current transaction.
		WRITE	1h	Start a master write transaction.
		READPREF	2h	Start a master read transaction to prefetchable memory.
		READNOPREF	3h	Start a master read transaction to nonprefetchable memory.
		CONFIGWRITE	4h	Start a configuration write.
		CONFIGREAD	5h	Start a configuration read.
		IOWRITE	6h	Start an I/O write.
		IOREAD	7h	Start an I/O read.

[†] For CSL implementation, use the notation PCI_PCIMC_field_symval

B.14.8 Current DSP Address Register (CDSPA)

The current DSP address register (CDSPA) contains the current DSP address for master transactions. The CDSPA is shown in Figure B–239 and described in Table B–248.

Figure B–239. Current DSP Address (CDSPA)

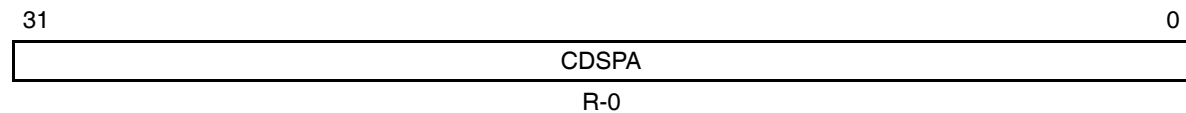

Legend: R = Read only; -n = value after reset

Table B–248. Current DSP Address (CDSPA) Field Values

Bit	Field	<i>symval</i> [†]	Value	Description
31–0	CDSPA	OF(<i>value</i>)	0–FFFF FFFFh	The current DSP address for master transactions.

[†] For CSL implementation, use the notation PCI_CDSPA_CDSPA_*symval*

B.14.9 Current PCI Address Register (CPCIA)

The current PCI address register (CPCIA) contains the current PCI address for master transactions. The CPCIA is shown in Figure B–240 and described in Table B–249.

Figure B–240. Current PCI Address Register (CPCIA)

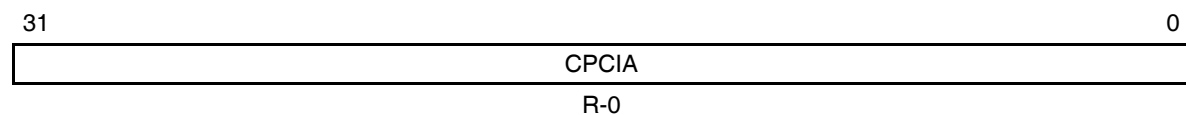

Legend: R = Read only; -n = value after reset

Table B–249. Current PCI Address Register (CPCIA) Field Values

Bit	Field	<i>symval</i> [†]	Value	Description
31–0	CPCIA	OF(<i>value</i>)	0–FFFF FFFFh	The current PCI address for master transactions

[†] For CSL implementation, use the notation PCI_CPCIA_CPCIA_*symval*

B.14.10 Current Byte Count Register (CCNT)

The current byte count register (CCNT) contains the number of bytes left on the current master transaction. The CCNT is shown in Figure B–241 and described in Table B–250.

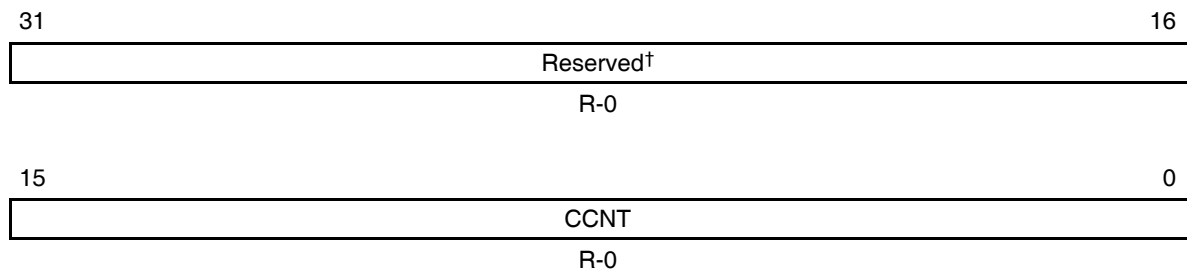
Figure B–241. Current Byte Count Register (CCNT)

Legend: R = Read only; -n = value after reset

† If writing to this field, always write the default value for future device compatibility.

Table B–250. Current Byte Count Register (CCNT) Field Values

Bit	Field	<i>symval</i> †	Value	Description
31–16	Reserved	–	0	Reserved. The reserved bit location always returns the default value. A value written to this field has no effect. If writing to this field, always write the default value for future device compatibility.
15–0	CCNT	OF(<i>value</i>)	0–FFFFh	The number of bytes left on the master transaction.

† For CSL implementation, use the notation `PCI_CCNT_CCNT_symval`

B.14.11 EEPROM Address Register (EEADD)

The EEPROM address register (EEADD) contains the EEPROM address. The EEADD is shown in Figure B–242 and described in Table B–251.

Figure B–242. EEPROM Address Register (EEADD)

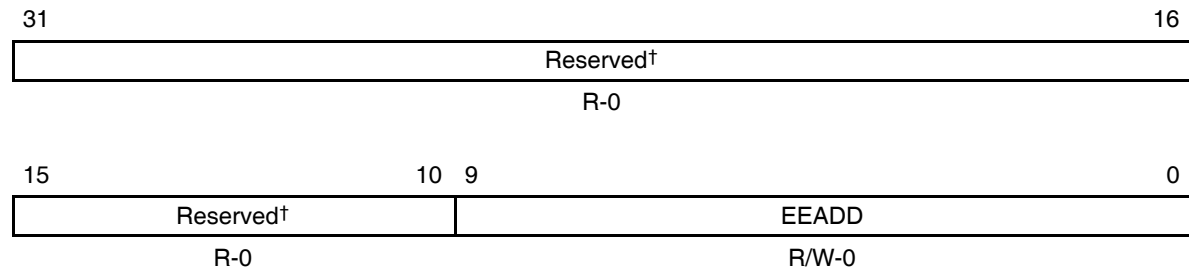

Legend: R = Read only; R/W = Read/Write; -*n* = value after reset

† If writing to this field, always write the default value for future device compatibility.

Table B–251. EEPROM Address Register (EEADD) Field Values

Bit	Field	symval†	Value	Description
31–10	Reserved	–	0	Reserved. The reserved bit location always returns the default value. A value written to this field has no effect. If writing to this field, always write the default value for future device compatibility.
9–0	EEADD	OF(<i>value</i>)	0–3FFh	EEPROM address.

† For CSL implementation, use the notation PCI_EEADD_EEADD_symval

B.14.12 EEPROM Data Register (EEDAT)

The EEPROM data register (EEDAT) is used to clock out user data to the EEPROM on writes and store EEPROM data on reads. For EEPROM writes, data written to EEDAT is immediately transferred to an internal register. A DSP read from EEDAT at this point does not return the value of the EEPROM data just written. The write data (stored in the internal register) is shifted out on the pins as soon as the two-bit op code is written to the EECNT bits in the EEPROM control register (EECTL). For EEPROM reads, data is available in EEDAT as soon as the READY bit in EECTL is set to 1. The EEDAT is shown in Figure B-243 and described in Table B-252.

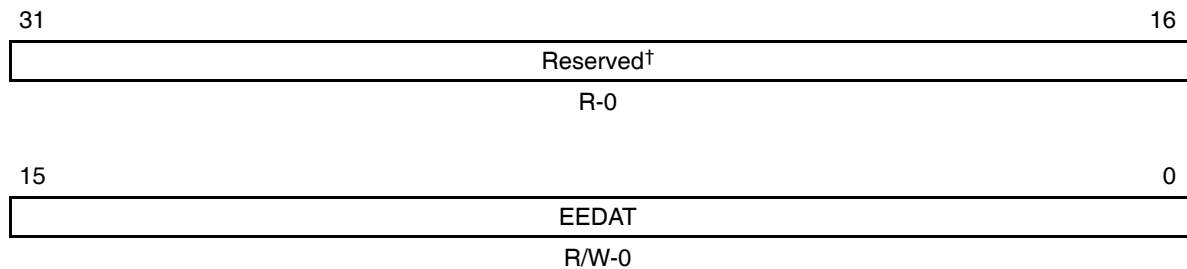
Figure B-243. EEPROM Data Register (EEDAT)

Legend: R = Read only; R/W = Read/Write; -*n* = value after reset

† If writing to this field, always write the default value for future device compatibility.

Table B-252. EEPROM Data Register (EEDAT) Field Values

Bit	Field	<i>symval</i> [†]	Value	Description
31-16	Reserved	-	0	Reserved. The reserved bit location always returns the default value. A value written to this field has no effect. If writing to this field, always write the default value for future device compatibility.
15-0	EEDAT	OF(<i>value</i>)	0-FFFFh	EEPROM data.

† For CSL implementation, use the notation `PCI_EEDAT_EEDAT_symval`

B.14.13 EEPROM Control Register (EECTL)

The EEPROM control register (EECTL) has fields for the two-bit opcode (EECNT) and read-only bits that indicate the size of the EEPROM (EESZ latched from the EESZ[2–0] pins on power-on reset). The READY bit in EECTL indicates when the last operation is complete, and the EEPROM is ready for a new instruction. The READY bit is cleared when a new op code is written to the EECNT bits. An interrupt can also be generated on EEPROM command completion. The EERDY bit in the PCI interrupt source register (PCIIS) and in the PCI interrupt enable register (PCIEN) control the operation of the interrupt. The EECTL is shown in Figure B–244 and described in Table B–253.

Figure B–244. EEPROM Control Register (EECTL)

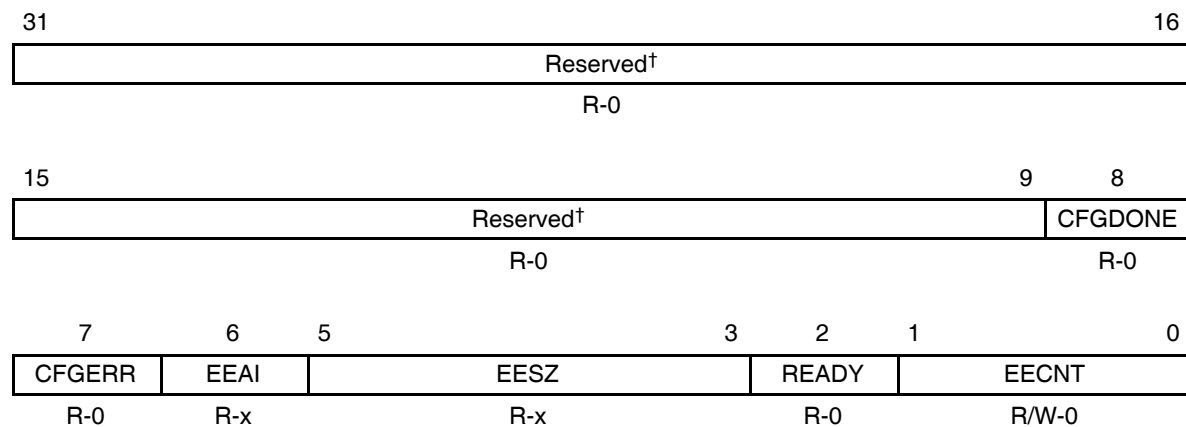

Legend: R = Read only; R/W = Read/Write; -n = value after reset; -x = value is indeterminate after reset

† If writing to this field, always write the default value for future device compatibility.

Table B–253. EEPROM Control Register (EECTL) Field Values

Bit	field†	symval†	Value	Description
31–9	Reserved	–	0	Reserved. The reserved bit location always returns the default value. A value written to this field has no effect. If writing to this field, always write the default value for future device compatibility.
8	CFGDONE	OF(value)	0	Configuration is not done.
			1	Configuration is done.

† For CSL implementation, use the notation PCI_EECTL_field_symval

Table B–253. EEPROM Control Register (EECTL) Field Values (Continued)

Bit	field [†]	symval [†]	Value	Description
7	CFGERR	OF(value)		Checksum failed error bit.
			0	No checksum error.
			1	Checksum error.
6	EEAI	OF(value)		EEAI pin state at power-on reset.
			0	PCI uses default values.
			1	Read PCI configuration register values from EEPROM.
5–3	EESZ	OF(value)		EESZ pins state at power-on reset.
			0	No EEPROM
			1h	1K bits (C6205 DSP only)
			2h	2K bits (C6205 DSP only)
			3h	4K bits
			4h	16K bits (C6205 DSP only)
			5h–7h	Reserved
2	READY	OF(value)		EEPROM is ready for a new command. Cleared on writes to the EECNT bit.
			0	EEPROM is not ready for a new command.
			1	EEPROM is ready for a new command.
1–0	EECNT			EEPROM op code. Writes to this field cause the serial operation to commence.
		EWEN	0	Write enable (address = 11xxxx)
		ERAL	0	Erases all memory locations (address = 10xxxx)
		WRAL	0	Writes all memory locations (address = 01xxxx)
		EWDS	0	Disables programming instructions (address = 00xxxx)
		WRITE	1h	Write memory at address
		READ	2h	Reads data at specified address
		ERASE	3h	Erase memory at address

[†] For CSL implementation, use the notation PCI_EECTL_field_symval

B.14.14 PCI Transfer Halt Register (HALT) (C62x/C67x)

The PCI transfer halt register (HALT) allows the C62x/C67x DSP to terminate internal transfer requests to the auxiliary DMA channel. The HALT is shown in Figure B–245 and described in Table B–254.

Figure B–245. PCI Transfer Halt Register (HALT)

31	Reserved [†]	1	0
	R-0		R/W-0

Legend: R = Read only; R/W = Read/Write; -n = value after reset

[†] If writing to this field, always write the default value for future device compatibility.

Table B–254. PCI Transfer Halt Register (HALT) Field Values

Bit	Field	symval [†]	Value	Description
31–1	Reserved	–	0	Reserved. The reserved bit location always returns the default value. A value written to this field has no effect. If writing to this field, always write the default value for future device compatibility.
0	HALT		0	Halt internal transfer requests bit.
			0	No effect.
		SET	1	HALT prevents the PCI port from performing master/slave auxiliary DMA transfer requests.

[†] For CSL implementation, use the notation PCI_HALT_HALT_symval

B.14.15 PCI Transfer Request Control Register (TRCTL) (C64x)

The PCI transfer request control register (TRCTL) controls how the PCI submits its requests to the EDMA subsystem. The TRCTL is shown in Figure B–246 and described in Table B–255.

To safely change the PALLOC or PRI bits in TRCTL, the TRSTALL bit needs to be used to ensure a proper transition. The following procedure must be followed to change the PALLOC or PRI bits:

- 1) Set the TRSTALL bit to 1 to stop the PCI from submitting TR requests on the current PRI level. In the same write, the desired new PALLOC and PRI bits may be specified.
- 2) Clear all EDMA event enables (EER) corresponding to both old and new PRI levels to stop the EDMA from submitting TR requests on both PRI levels. Do not manually submit additional events via the EDMA.
- 3) Do not submit new QDMA requests on either old or new PRI level.
- 4) Stop L2 cache misses on either old or new PRI level. This can be done by forcing program execution or data accesses in internal memory. Another way is to have the CPU executing a tight loop that does not cause additional cache misses.
- 5) Poll the appropriate PQ bits in the priority queue status register (PQSR) of the EDMA until both queues are empty (see the *Enhanced DMA (EDMA) Controller Reference Guide*, SPRU234).
- 6) Clear the TRSTALL bit to 0 to allow the PCI to continue normal operation.

Requestors are halted on the old PCI PRI level so that memory ordering can be preserved. In this case, all pending requests corresponding to the old PRI level must be allowed to complete before PCI is released from stall state.

Requestors are halted on the new PRI level to ensure that at no time can the sum of all requestor allocations exceed the queue length. By halting all requestors at a given level, you can be free to modify the queue allocation counters of each requestor.

Figure B–246. PCI Transfer Request Control Register (TRCTL)

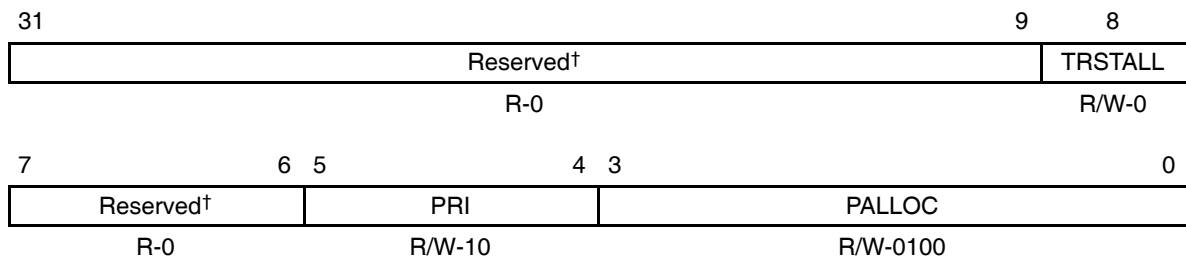

Legend: R = Read only; R/W = Read/Write; -n = value after reset

† If writing to this field, always write the default value for future device compatibility.

Table B–255. PCI Transfer Request Control Register (TRCTL) Field Values

Bit	field [†]	symval [†]	Value	Description
31–9	Reserved	–	0	Reserved. The reserved bit location always returns the default value. A value written to this field has no effect. If writing to this field, always write the default value for future device compatibility.
8	TRSTALL	OF(<i>value</i>)		Forces the PCI to stall all PCI requests to the EDMA. This bit allows the safe changing of the PALLOC and PRI fields.
		DEFAULT	0	Allows PCI requests to be submitted to the EDMA.
			1	Halts the creation of new PCI requests to the EDMA.
7–6	Reserved	–	0	Reserved. The reserved bit location always returns the default value. A value written to this field has no effect. If writing to this field, always write the default value for future device compatibility.
5–4	PRI	OF(<i>value</i>)	0–3h	Controls the priority queue level that PCI requests are submitted to.
			0	Urgent priority
			1h	High priority
		DEFAULT	2h	Medium priority
			3h	Low priority
3–0	PALLOC	OF(<i>value</i>)	0–Fh	Controls the total number of outstanding requests that can be submitted by the PCI to the EDMA. Valid values of PALLOC are 1 to 15, all other values are reserved. PCI may have the programmed number of outstanding requests.
		–	0	Reserved
		DEFAULT	4h	Four outstanding requests can be submitted by the PCI to the EDMA.

[†] For CSL implementation, use the notation PCI_TRCTL_field_symval

B.15 Phase-Locked Loop (PLL) Registers

Table B–256. PLL Controller Registers

Acronym	Register Name	Section
PLLPID	PLL controller peripheral identification register	B.15.1
PLLCSR	PLL control/status register	B.15.2
PLLM	PLL multiplier control register	B.15.3
PLLDIV0–3	PLL controller divider registers	B.15.4
OSCDIV1	Oscillator divider 1 register	B.15.5

B.15.1 PLL Controller Peripheral Identification Register (PLLPID)

The PLL controller peripheral identification register (PLLPID) contains identification code for the PLL controller. PLLPID is shown in Figure B–152 and described in Table B–159.

Figure B–247. PLL Controller Peripheral Identification Register (PLLPID)

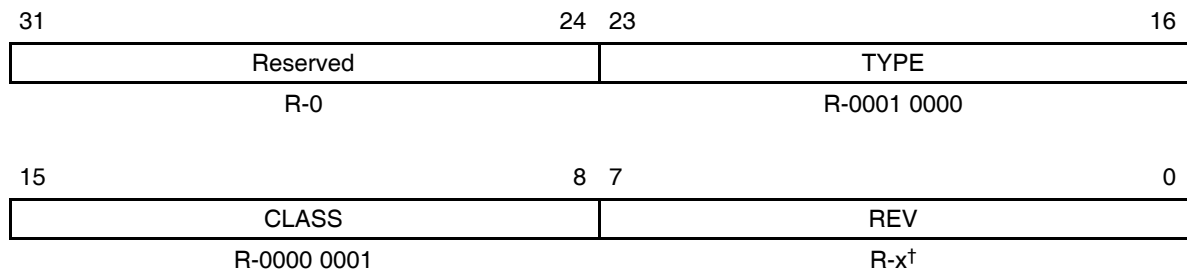

Legend: R = Read only; -x = value after reset

† See the device-specific datasheet for the default value of this field.

Table B–257. PLL Controller Peripheral Identification Register (PLLPID) Field Values

Bit	field†	symval†	Value	Description
31–24	Reserved	–	0	These Reserved bit locations are always read as zeros. A value written to this field has no effect.
23–16	TYPE	OF(value)		Identifies type of peripheral.
			10h	PLL controller
15–8	CLASS	OF(value)		Identifies class of peripheral.
			1	Serial port
7–0	REV	OF(value)		Identifies revision of peripheral.
			x	See the device-specific datasheet for the value.

† For CSL implementation, use the notation PLL_PID_field_symval

B.15.2 PLL Control/Status Register (PLLCSR)

The PLL control/status register (PLLCSR) is shown in Figure B–248 and described in Table B–258.

Figure B–248. PLL Control/Status Register (PLLCSR)

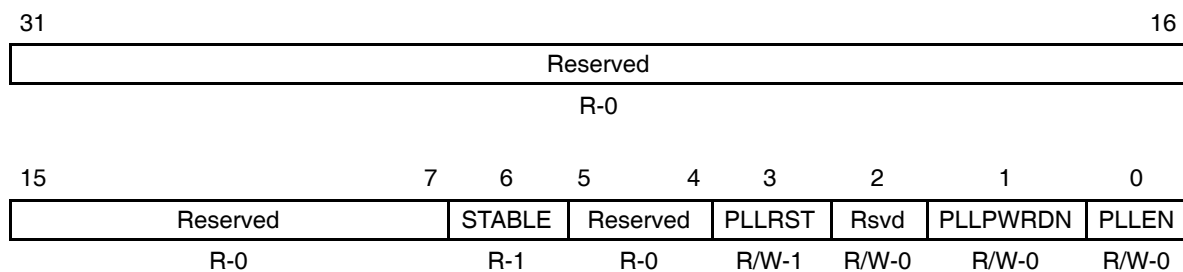

Legend: R = Read only; R/W = Read/write; -n = value after reset

Table B–258. PLL Control/Status Register (PLLCSR) Field Values

Bit	field [†]	symval [†]	Value	Description
31–7	Reserved	–	0	Reserved. The reserved bit location is always read as zero. A value written to this field has no effect.
6	STABLE	OF(<i>value</i>)	0	Oscillator input stable bit indicates if the OSCIN/CLKIN input has stabilized. The STABLE bit is set to 1 after the reset controller counts 4096 input clock cycles after the $\overline{\text{RESET}}$ signal is asserted high.
			0	OSCIN/CLKIN input is not yet stable. Oscillator counter is not finished counting.
			1	OSCIN/CLKIN input is stable.
5–4	Reserved	–	0	Reserved. The reserved bit location is always read as zero. Always write a 0 to this location.
3	PLL RST			PLL reset bit.
		0	0	PLL reset is released.
		1	1	PLL reset is asserted.
2	Reserved	–	0	Reserved. The reserved bit location is always read as zero. Always write a 0 to this location.
1	PLL PWRDN			PLL power-down mode select bit.
		NO	0	PLL is operational.
		YES	1	PLL is placed in power-down state.
0	PLLEN			PLL enable bit.
		BYPASS	0	Bypass mode. Divider D0 and PLL are bypassed. SYSCLK1/SYSCLK2/SYSCLK3 are divided down directly from input reference clock.
		ENABLE	1	PLL mode. PLL output path is enabled. Divider D0 and PLL are not bypassed. SYSCLK1/SYSCLK2/SYSCLK3 are divided down from PLL output.

[†] For CSL implementation, use the notation PLL_PLLCSR_ *field_symval*

B.15.3 PLL Multiplier Control Register (PLLM)

The PLL multiplier control register (PLLM) is shown in Figure B–249 and described in Table B–259. The PLLM defines the input reference clock frequency multiplier in conjunction with the PLL divider ratio bits (RATIO) in the PLL controller divider 0 register (PLLDIV0).

Figure B–249. PLL Multiplier Control Register (PLLM)

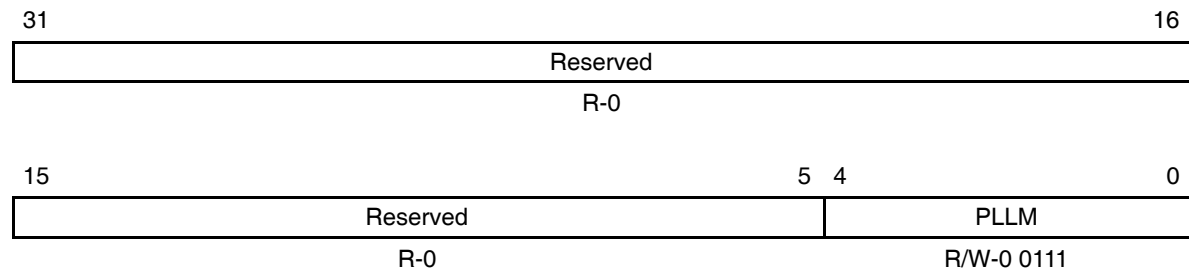

Legend: R = Read only; R/W = Read/write; -n = value after reset

Table B–259. PLL Multiplier Control Register (PLLM) Field Values

Bit	Field	symval [†]	Value	Description
31–5	Reserved	–	0	Reserved. The reserved bit location is always read as zero. A value written to this field has no effect.
4–0	PLLM	OF(value)	0–1Fh	PLL multiplier bits. Defines the frequency multiplier of the input reference clock in conjunction with the PLL divider ratio bits (RATIO) in PLLDIV0. See the device-specific datasheet for the PLL multiplier rates supported on your device.
		DEFAULT	7h	

[†] For CSL implementation, use the notation PLL_PLLM_PLLM_symval

B.15.4 PLL Controller Divider Registers (PLLDIV0–3)

The PLL controller divider register (PLLDIV) is shown in Figure B–250 and described in Table B–260.

Figure B–250. PLL Controller Divider Register (PLLDIV)

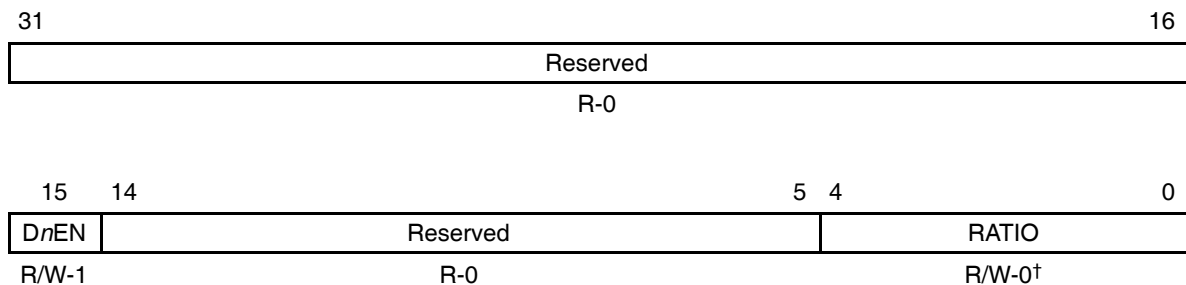

Legend: R = Read only; R/W = Read/write; -n = value after reset

† For PLLDIV0 and PLLDIV1; for PLLDIV2 and PLLDIV3, reset value is 0 0001.

Table B–260. PLL Controller Divider Register (PLLDIV) Field Values

Bit	field†	symval†	Value	Description
31–16	Reserved	–	0	Reserved. The reserved bit location is always read as zero. A value written to this field has no effect.
15	DnEN			Divider Dn enable bit.
		DISABLE	0	Divider n is disabled. No clock output.
		ENABLE	1	Divider n is enabled.
14–5	Reserved	–	0	Reserved. The reserved bit location is always read as zero. A value written to this field has no effect.
4–0	RATIO	OF(value)		PLL divider ratio bits. For PLLDIV0, defines the input reference clock frequency multiplier in conjunction with the PLL multiplier bits (PLLM) in PLLM. For PLLDIV1–3, defines the PLL output clock frequency divider ratio.
			0	÷1. Divide frequency by 1.
			1h	÷2. Divide frequency by 2.
			2h–1Fh	÷3 to ÷32. Divide frequency by 3 to divide frequency by 32.

† For CSL implementation, use the notation PLL_PLLDIVn_field_symval

B.15.5 Oscillator Divider 1 Register (OSCDIV1)

The oscillator divider 1 register (OSCDIV1) is shown in Figure B–251 and described in Table B–261.

Figure B–251. Oscillator Divider 1 Register (OSCDIV1)

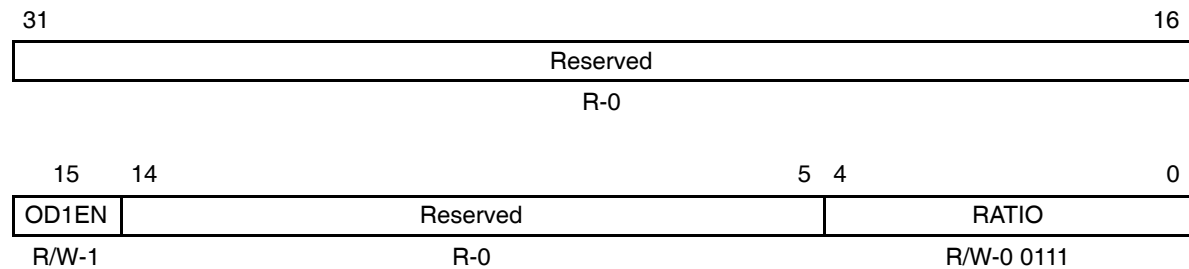

Legend: R = Read only; R/W = Read/write; -n = value after reset

Table B–261. Oscillator Divider 1 Register (OSCDIV1) Field Values

Bit	field [†]	symval [†]	Value	Description
31–16	Reserved	–	0	Reserved. The reserved bit location is always read as zero. A value written to this field has no effect.
15	OD1EN			Oscillator divider enable bit.
		DISABLE	0	Oscillator divider is disabled. No clock output.
		ENABLE	1	Oscillator divider is enabled.
14–5	Reserved	–	0	Reserved. The reserved bit location is always read as zero. A value written to this field has no effect.
4–0	RATIO	OF(value)	0–1Fh	Oscillator divider ratio bits. Defines the input reference clock frequency divider ratio for output clock CLKOUT3.
			0	÷1. Divide input reference clock frequency by 1.
			1h	÷2. Divide input reference clock frequency by 2.
			2h–6h	÷3 to ÷7. Divide input reference clock frequency by 3 to divide input reference clock frequency by 7.
		DEFAULT	7h	÷8. Divide input reference clock frequency by 8.
			8h–1Fh	÷9 to ÷32. Divide input reference clock frequency by 9 to divide input reference clock frequency by 32.

[†] For CSL implementation, use the notation PLL_OSCDIV1_field_symval

B.16 Power-Down Control Register

Figure B–252. Power-Down Control Register (PDCTL)

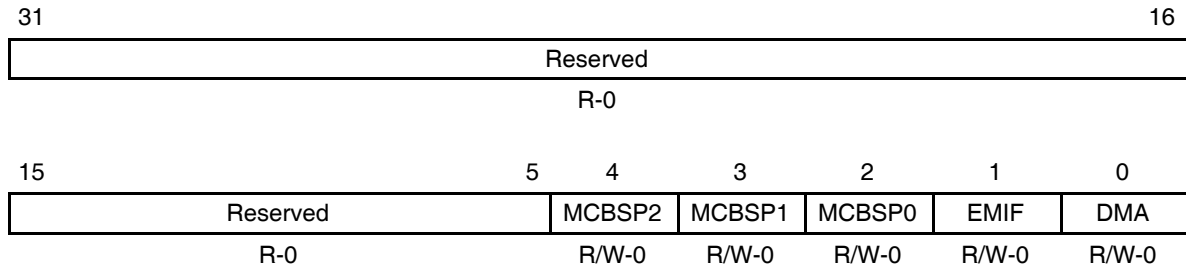

Legend: R/W-x = Read/Write-Reset value

Table B–262. Power-Down Control Register (PDCTL) Field Values

Bit	<i>field</i> [†]	<i>symval</i> [†]	Value	Description
31–5	Reserved	–	0	Reserved. The reserved bit location is always read as zero. A value written to this field has no effect.
4	MCBSP2			Internal McBSP2 clock enable bit.
		CLKON	0	Internal McBSP2 clock is enabled.
		CLKOFF	1	Internal McBSP2 clock is disabled. McBSP2 is not functional.
3	MCBSP1			Internal McBSP1 clock enable bit.
		CLKON	0	Internal McBSP1 clock is enabled.
		CLKOFF	1	Internal McBSP1 clock is disabled. McBSP1 is not functional.
2	MCBSP0			Internal McBSP0 clock enable bit.
		CLKON	0	Internal McBSP0 clock is enabled.
		CLKOFF	1	Internal McBSP0 clock is disabled. McBSP1 is not functional.
1	EMIF			Internal EMIF clock enable bit.
		CLKON	0	Internal EMIF clock is enabled.
		CLKOFF	1	Internal EMIF clock is disabled. EMIF is not functional.
0	DMA			Internal DMA clock enable bit.
		CLKON	0	Internal DMA clock is enabled.
		CLKOFF	1	Internal DMA clock is disabled. DMA is not functional.

[†] For CSL implementation, use the notation PWR_PDCTL_ *field_symval*

B.17 TCP Registers

The TCP contains several memory-mapped registers accessible by way of the CPU, QDMA, and EDMA. A peripheral-bus access is faster than an EDMA-bus access for isolated accesses (typically when accessing control registers). EDMA-bus accesses are intended to be used for EDMA transfers and are meant to provide maximum throughput to/from the TCP.

The memory map is listed in Table B–263. All TCP memories (systematic and parity, interleaver, hard decisions, a priori, and extrinsic) are regarded as FIFOs by the DSP, meaning you do not have to perform any indexing on the addresses.

Table B–263. TCP Registers

Start Address (hex)		Acronym	Register Name	Section
EDMA Bus	Peripheral Bus			
5800 0000	01BA 0000	TCPIC0	TCP input configuration register 0	B.17.1
5800 0004	01BA 0004	TCPIC1	TCP input configuration register 1	B.17.2
5800 0008	01BA 0008	TCPIC2	TCP input configuration register 2	B.17.3
5800 000C	01BA 000C	TCPIC3	TCP input configuration register 3	B.17.4
5800 0010	01BA 0010	TCPIC4	TCP input configuration register 4	B.17.5
5800 0014	01BA 0014	TCPIC5	TCP input configuration register 5	B.17.6
5800 0018	01BA 0018	TCPIC6	TCP input configuration Register 6	B.17.7
5800 001C	01BA 001C	TCPIC7	TCP input configuration register 7	B.17.8
5800 0020	01BA 0020	TCPIC8	TCP input configuration register 8	B.17.9
5800 0024	01BA 0024	TCPIC9	TCP input configuration register 9	B.17.10
5800 0028	01BA 0028	TCPIC10	TCP input configuration register 10	B.17.11
5800 002C	01BA 002C	TCPIC11	TCP input configuration register 11	B.17.12
5800 0030	01BA 0030	TCPOUT	TCP output parameters register	B.17.13
–	01BA 0038	TCPEXE	TCP execution register	B.17.14
–	01BA 0040	TCPEND	TCP endian register	B.17.15
–	01BA 0050	TCPERR	TCP error register	B.17.16
–	01BA 0058	TCPSTAT	TCP status register	B.17.17

B.17.1 TCP Input Configuration Register 0 (TCPIC0)

The TCP input configuration register 0 (TCPIC0) is shown in Figure B–253 and described in Table B–264. TCPIC0 is used to configure the TCP.

Figure B–253. TCP Input Configuration Register 0 (TCPIC0)

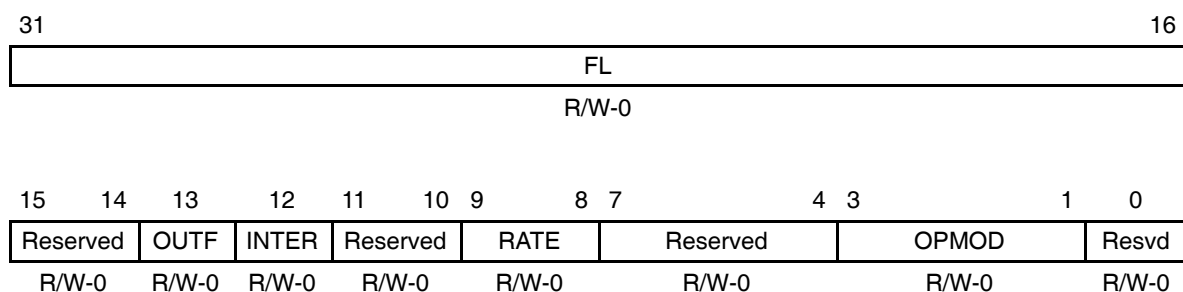

Legend: R/W = Read/Write; -n = value after reset

Table B–264. TCP Input Configuration Register 0 (TCPIC0) Field Values

Bit	field [†]	symval [†]	Value	Description
31–16	FL	OF(value)	40–20730	Frame length. Number of symbols in the frame to be decoded (not including tail symbols).
15–14	Reserved	–	0	Reserved. The reserved bit location is always read as 0. A value written to this field has no effect.
13	OUTF			Output parameters read flag (SA mode only; in SP mode, must be cleared to 0).
		NO	0	No REVT generation. Output parameters are not read via EDMA.
		YES	1	REVT generation. Output parameters are read via EDMA.
12	INTER			Interleaver write flag.
		NO	0	Interleaver table is not sent to the TCP (required for SP mode)
		YES	1	Interleaver table is sent to the TCP (required for SA mode)
11–10	Reserved	–	0	Reserved. The reserved bit location is always read as 0. A value written to this field has no effect.

[†] For CSL implementation, use the notation TCP_IC0_field_symval

Table B–264. TCP Input Configuration Register 0 (TCPIC0) Field Values (Continued)

Bit	field [†]	symval [†]	Value	Description
9–8	RATE		0–3h	Code rate.
		DEFAULT	0	Reserved
		1_2	1h	Rate 1/2
		1_3	2h	Rate 1/3
		1_4	3h	Rate 1/4
7–4	Reserved	–	0	Reserved. The reserved bit location is always read as 0. A value written to this field has no effect.
3–1	OPMOD		0–7h	Operational mode.
		SA	0	SA mode
		–	1h–3h	Reserved
		MAP1A	4h	SP mode MAP1 (first iteration)
		MAP1B	5h	SP mode MAP1 (any other iteration)
		–	6h	Reserved
		MAP2	7h	SP mode MAP2
0	Reserved	–	0	Reserved. The reserved bit location is always read as 0. A value written to this field has no effect.

[†] For CSL implementation, use the notation TCP_IC0_field_symval

B.17.2 TCP Input Configuration Register 1 (TCPIC1)

The TCP input configuration register 1 (TCPIC1) is shown in Figure B–254 and described in Table B–265. TCPIC1 is used to configure the TCP.

Figure B–254. TCP Input Configuration Register 1 (TCPIC1)

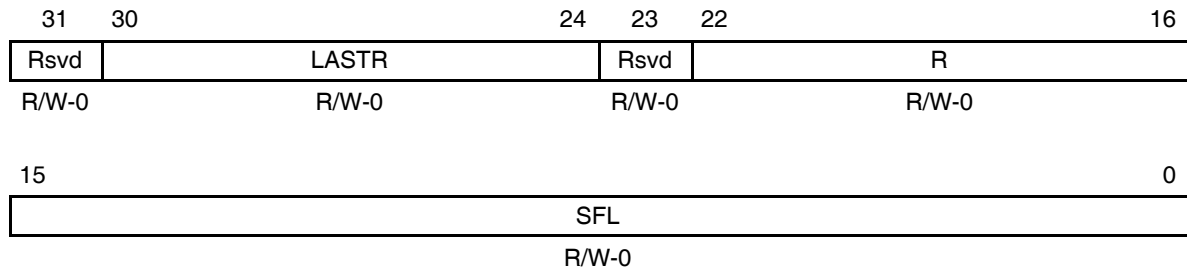

Legend: R/W = Read/Write; -n = value after reset

Table B–265. TCP Input Configuration Register 1 (TCPIC1) Field Values

Bit	field [†]	symval [†]	Value	Description
31	Reserved	–	0	Reserved. The reserved bit location is always read as 0. A value written to this field has no effect.
30–24	LASTR	OF(value)	0–127	Last subframe reliability length – 1: (SP mode only; don't care in SA mode). Number of symbols – 1 to be used in the reliability portion the last subframe.
23	Reserved	–	0	Reserved. The reserved bit location is always read as 0. A value written to this field has no effect.
22–16	R	OF(value)	39–127	Reliability length – 1 (from 39 to 127). Number of symbols – 1 to be used in the reliability portion of a frame or subframe.
15–0	SFL	OF(value)	98–5114	Subframe length (from 98 to 5114): (SP mode only; don't care in SA mode). Number of symbols in a subframe including the header and tail prolog symbols. Maximum is 5114.

[†] For CSL implementation, use the notation TCP_IC1_field_symval

B.17.3 TCP Input Configuration Register 2 (TCPIC2)

The TCP input configuration register 2 (TCPIC2) is shown in Figure B–255 and described in Table B–266. TCPIC2 is used to configure the TCP.

Figure B–255. TCP Input Configuration Register 2 (TCPIC2)

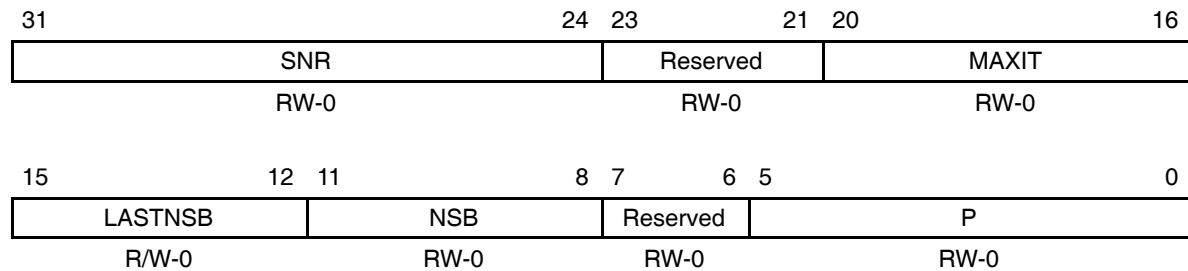

Legend: R/W = Read/Write; -n = value after reset

Table B–266. TCP Input Configuration Register 2 (TCPIC2) Field Values

Bit	field [†]	symval [†]	Value	Description
31–24	SNR	OF(value)	0–100	SNR threshold (from 0 to 100) (SA mode only; don't care in SP mode).
		DEFAULT	0	Disables stopping criteria.
23–21	Reserved	–	0	Reserved. The reserved bit location is always read as 0. A value written to this field has no effect.
20–16	MAXIT	OF(value)	0–31	Maximum number of iterations (from 0 to 32) (SA mode only; don't care in SP mode).
		DEFAULT	0	Sets MAXIT to 32.
15–12	LASTNSB	OF(value)	0–15	Number of subblocks in the last subframe (SP mode only; don't care in SA mode).
11–8	NSB	OF(value)	0–15	Number of subblocks.
7–6	Reserved	–	0	Reserved. The reserved bit location is always read as 0. A value written to this field has no effect.
5–0	P	OF(value)	24–48	Prolog size (from 24 to 48). Number of symbols for the prolog. TCP forces value to 24, if the size is smaller than 24. In SP mode, P must be a multiple of 8 for rate 1/2 and 1/3, and a multiple of 16 for rate 1/4.

[†] For CSL implementation, use the notation TCP_IC2_field_symval

B.17.4 TCP Input Configuration Register 3 (TCPIC3)

The TCP input configuration register 3 (TCPIC3) is shown in Figure B–256 and described in Table B–267. TCPIC3 is used to inform the TCP on the EDMA data flow segmentation.

Figure B–256. TCP Input Configuration Register 3 (TCPIC3)

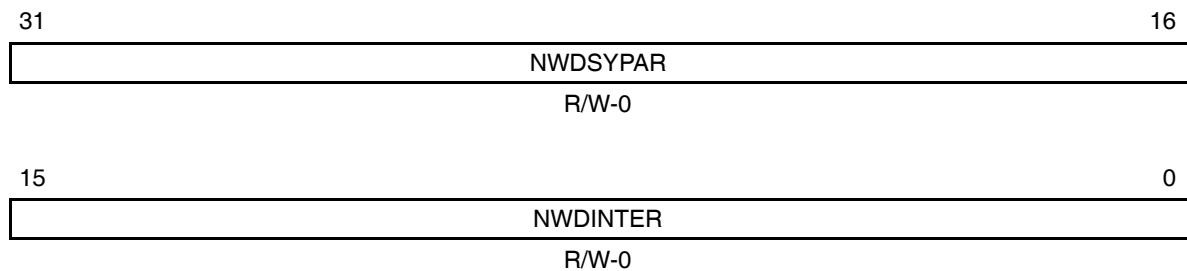

Legend: R/W = Read/Write; -n = value after reset

Table B–267. TCP Input Configuration Register 3 (TCPIC3) Field Values

Bit	field [†]	symval [†]	Value	Description
31–16	NWDSYPAR	OF(value)	0–FFFFh	Number of systematic and parity words per XEVT.
15–0	NWDINTER	OF(value)	0–FFFFh	Number of interleaver words per XEVT (SA mode only; don't care in SP mode).

[†] For CSL implementation, use the notation TCP_IC3_field_symval

B.17.5 TCP Input Configuration Register 4 (TCPIC4)

The TCP input configuration register 4 (TCPIC4) is shown in Figure B–257 and described in Table B–268. TCPIC4 is used to inform the TCP on the EDMA data flow segmentation.

Figure B–257. TCP Input Configuration Register 4 (TCPIC4)

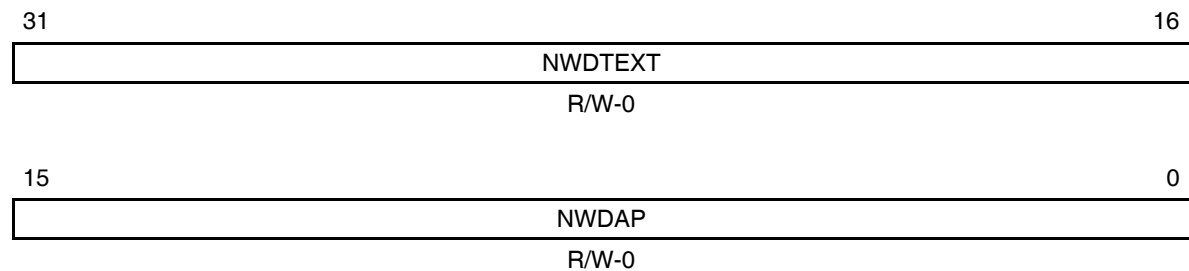

Legend: R/W = Read/Write; -n = value after reset

Table B–268. TCP Input Configuration Register 4 (TCPIC4) Field Values

Bit	field [†]	symval [†]	Value	Description
31–16	NWDTEXT	OF(value)	0–FFFFh	Number of extrinsic words per REVT (SP mode only; don't care in SA mode).
15–0	NWDAP	OF(value)	0–FFFFh	Number of a priori words per XEVT (SP mode only; don't care in SA mode).

[†] For CSL implementation, use the notation TCP_IC4_field_symval

B.17.6 TCP Input Configuration Register 5 (TCPIC5)

The TCP input configuration register 5 (TCPIC5) is shown in Figure B–258 and described in Table B–269. TCPIC5 is used to inform the TCP on the EDMA data flow segmentation.

Figure B–258. TCP Input Configuration Register 5 (TCPIC5)

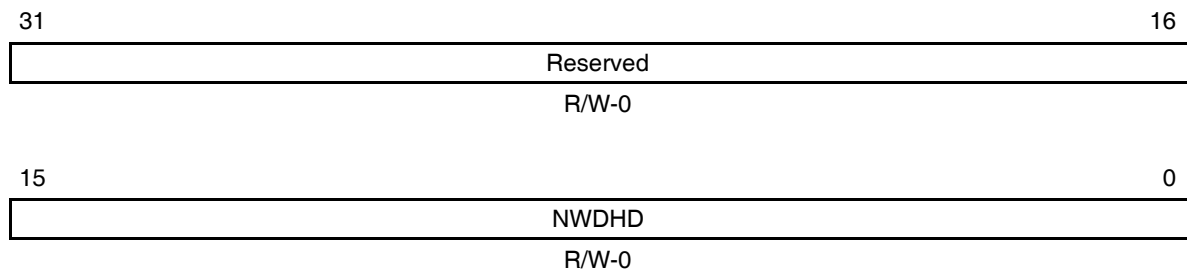

Legend: R/W = Read/Write; -n = value after reset

Table B–269. TCP Input Configuration Register 5 (TCPIC5) Field Values

Bit	field [†]	symval [†]	Value	Description
31–16	Reserved	–	0	Reserved. The reserved bit location is always read as 0. A value written to this field has no effect.
15–0	NWDHD	OF(value)	0–FFFFh	Number of hard decisions words per REVT (SA mode only; don't care in SP mode).

[†] For CSL implementation, use the notation TCP_IC5_field_symval

B.17.7 TCP Input Configuration Register 6 (TCPIC6)

The TCP input configuration register 6 (TCPIC6) is shown in Figure B–259 and described in Table B–270. TCPIC6 is used to set the tail bits used by the TCP.

Tail bits value must be set as following:

- SA mode and SP mode MAP1:

- For IS2000 rate 1/2 and 3GPP rate 1/3:

31–24	23–16	15–8	7–0
0	X_{F+2}	X_{F+1}	X_F

- For IS2000 rate 1/3 and 1/4: the systematics are repeated twice at the transmitter but are not necessarily the same at the receiver. You can program the first (X^1_{F+2}) or the second (X^2_{F+2}) received systematic tail symbol, or the addition and saturation of the two (*).

31–24	23–16	15–8	7–0
0	$(X^1_{F+2} + X^2_{F+2})^*$ or X^1_{F+2} or X^2_{F+2}	$(X^1_{F+1} + X^2_{F+1})^*$ or X^1_{F+1} or X^2_{F+1}	$(X^1_F + X^2_F)^*$ or X^1_F or X^2_F

- SP mode MAP2:

- For IS2000 rate 1/2 and 3GPP rate 1/3:

31–24	23–16	15–8	7–0
0	X'_{F+2}	X'_{F+1}	X'_F

- For IS2000 rate 1/3 and 1/4: the systematics are repeated twice at the transmitter but are not necessarily the same at the receiver. You can program the first (X^1_{F+2}) or the second (X^2_{F+2}) received systematic tail symbol, or the addition and saturation of the two (*).

31–24	23–16	15–8	7–0
0	$(X^1_{F+2} + X^2_{F+2})^*$ or X^1_{F+2} or X^2_{F+2}	$(X^1_{F+1} + X^2_{F+1})^*$ or X^1_{F+1} or X^2_{F+1}	$(X^1_F + X^2_F)^*$ or X^1_F or X^2_F

Figure B–259. TCP Input Configuration Register 6 (TCPIC6)

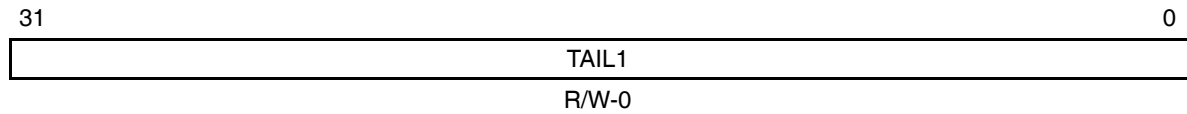

Legend: R/W = Read/Write; -n = value after reset

Table B–270. TCP Input Configuration Register 6 (TCPIC6) Field Values

Bit	field [†]	symval [†]	Value	Description
31–0	TAIL1	OF(value)	0–FFFF FFFFh	Tail bits.

[†] For CSL implementation, use the notation TCP_IC6_field_symval

B.17.8 TCP Input Configuration Register 7 (TCPIC7)

The TCP input configuration register 7 (TCPIC7) is shown in Figure B–260 and described in Table B–271. TCPIC7 is used to set the tail bits used by the TCP.

Tail bits value must be set as following:

- SA mode and SP mode MAP1 all rates:

31–24	23–16	15–8	7–0
0	A_{t+2}	A_{t+1}	A_t

- SP mode MAP2 rate 1/2 and rate 1/3:

31–24	23–16	15–8	7–0
0	A'_{t+2}	A'_{t+1}	A'_t

- SP mode MAP2 rate 1/4:

31–24	23–16	15–8	7–0
0	B'_{t+2}	B'_{t+1}	B'_t

Figure B–260. TCP Input Configuration Register 7 (TCPIC7)

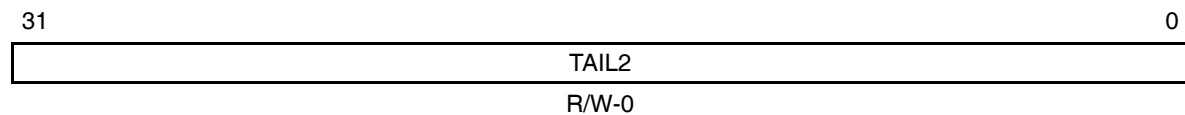

Legend: R/W = Read/Write; -n = value after reset

Table B–271. TCP Input Configuration Register 7 (TCPIC7) Field Values

Bit	field†	symval†	Value	Description
31–0	TAIL2	OF(value)	0–FFFF FFFFh	Tail bits.

† For CSL implementation, use the notation TCP_IC7_field_symval

B.17.9 TCP Input Configuration Register 8 (TCPIC8)

The TCP input configuration register 8 (TCPIC8) is shown in Figure B–261 and described in Table B–272. TCPIC8 is used to set the tail bits used by the TCP.

Tail bits value must be set as following:

- SA mode and SP mode MAP1:

- For rate 1/2 and 1/3:

31–24	23–16	15–8	7–0
0	0	0	0

- For rate 1/4:

31–24	23–16	15–8	7–0
0	B_{t+2}	B_{t+1}	B_t

- SP mode MAP2:

- For rate 1/2 and 1/3:

31–24	23–16	15–8	7–0
0	0	0	0

- For rate 1/4:

31–24	23–16	15–8	7–0
0	A'_{t+2}	A'_{t+1}	A'_t

Figure B–261. TCP Input Configuration Register 8 (TCPIC8)

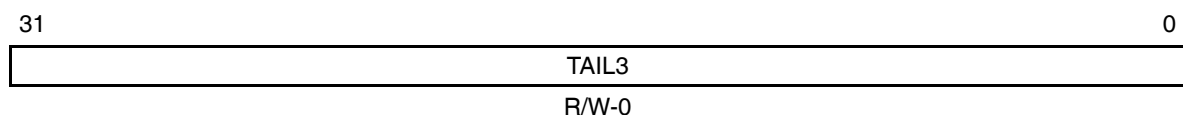

Legend: R/W = Read/Write; -n = value after reset

Table B–272. TCP Input Configuration Register 8 (TCPIC8) Field Values

Bit	field [†]	symval [†]	Value	Description
31–0	TAIL3	OF(value)	0–FFFF FFFFh	Tail bits.

[†] For CSL implementation, use the notation TCP_IC8_field_symval

B.17.10 TCP Input Configuration Register 9 (TCPIC9)

The TCP input configuration register 9 (TCPIC9) is shown in Figure B–262 and described in Table B–273. TCPIC9 is used to set the tail bits used by the TCP.

Tail bits value must be set as following:

- For IS2000 rate 1/2 and 3GPP rate 1/3:

31–24	23–16	15–8	7–0
0	X'_{F+2}	X'_{F+1}	X'_F

- For IS2000 rate 1/3 and 1/4: the systematics are repeated twice at the transmitter but are not necessarily the same at the receiver. You can program the first (X'^1_{F+2}) or the second (X'^2_{F+2}) or the average of the two.

31–24	23–16	15–8	7–0
0	$(X'^1_{F+2} + X'^2_{F+2})/2$ or X'^1_{F+2} or X'^2_{F+2}	$(X'^1_{F+1} + X'^2_{F+1})/2$ or X'^1_{F+1} or X'^2_{F+1}	$(X'^1_F + X'^2_F)/2$ or X'^1_F or X'^2_F

Figure B–262. TCP Input Configuration Register 9 (TCPIC9)

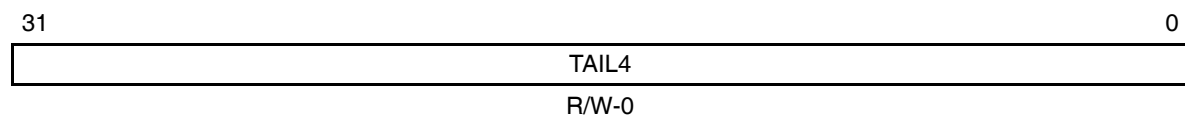

Legend: R/W = Read/Write; -n = value after reset

Table B–273. TCP Input Configuration Register 9 (TCPIC9) Field Values

Bit	field [†]	symval [†]	Value	Description
31–0	TAIL4	OF(value)	0–FFFF FFFFh	Tail bits. (SA mode only; don't care in SP mode.)

[†] For CSL implementation, use the notation TCP_IC9_field_symval

B.17.11 TCP Input Configuration Register 10 (TCPIC10)

The TCP input configuration register 10 (TCPIC10) is shown in Figure B–263 and described in Table B–274. TCPIC10 is used to set the tail bits used by the TCP.

Tail bits value must be set as following:

31–24	23–16	15–8	7–0
0	A'_{t+2}	A'_{t+1}	A'_t

Figure B–263. TCP Input Configuration Register 10 (TCPIC10)

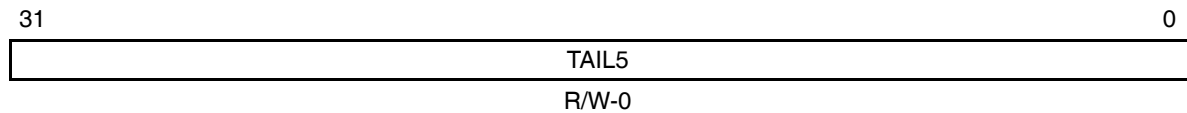

Legend: R/W = Read/Write; -n = value after reset

Table B–274. TCP Input Configuration Register 10 (TCPIC10) Field Values

Bit	field [†]	symval [†]	Value	Description
31–0	TAIL5	OF(value)	0–FFFF FFFFh	Tail bits. (SA mode only; don't care in SP mode.)

[†] For CSL implementation, use the notation TCP_IC10_field_symval

B.17.12 TCP Input Configuration Register 11 (TCPIC11)

The TCP input configuration register 11 (TCPIC11) is shown in Figure B–264 and described in Table B–275. TCPIC11 is used to set the tail bits used by the TCP.

Tail bits value must be set as following:

- For rate 1/4:

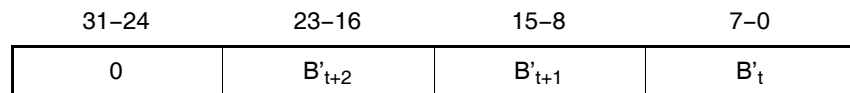

- For rate 1/2 and 1/3:

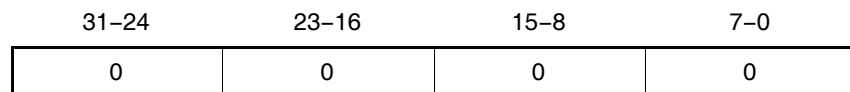
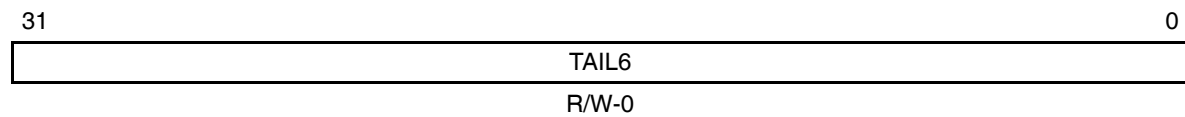

Figure B–264. TCP Input Configuration Register 11 (TCPIC11)



Legend: R/W = Read/Write; -n = value after reset

Table B–275. TCP Input Configuration Register 11 (TCPIC11) Field Values

Bit	field [†]	symval [†]	Value	Description
31–0	TAIL6	OF(value)	0–FFFF FFFFh	Tail bits. (SA mode only; don't care in SP mode.)

[†] For CSL implementation, use the notation TCP_IC11_field_symval

B.17.13 TCP Output Parameter Register (TCPOUT)

The TCP output parameter register (TCPOUT) is shown in Figure B–265 and described in Table B–276.

Figure B–265. TCP Output Parameter Register (TCPOUT)

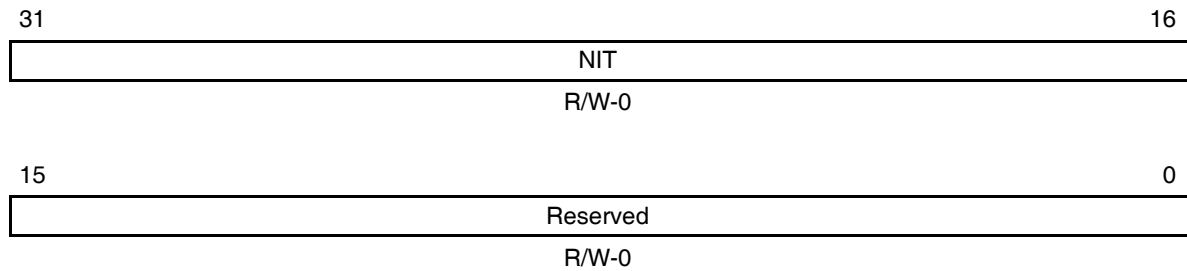

Legend: R/W = Read/Write; -n = value after reset

Table B–276. TCP Output Parameter Register (TCPOUT) Field Values

Bit	field [†]	symval [†]	Value	Description
31–16	NIT	OF(value)	0–FFFFh	Indicates the number of executed iterations – 1 and has no meaning in SP mode.
15–0	Reserved	–	0	Reserved. The reserved bit location is always read as 0. A value written to this field has no effect.

[†] For CSL implementation, use the notation TCP_OUT_field_symval

B.17.14 TCP Execution Register (TCPEXE)

The TCP execution register (TCPEXE) is shown in Figure B–266 and described in Table B–277.

Figure B–266. TCP Execution Register (TCPEXE)

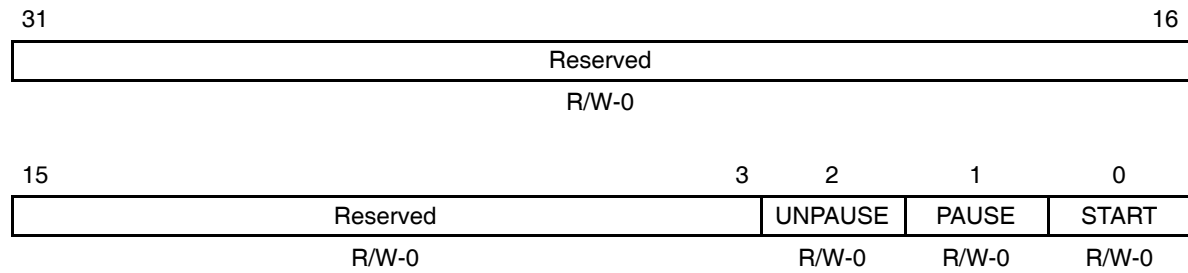

Legend: R/W = Read/Write; -n = value after reset

Table B–277. TCP Execution Register (TCPEXE) Field Values

Bit	field [†]	symval [†]	Value	Description
31–3	Reserved	–	0	Reserved. The reserved bit location is always read as 0. A value written to this field has no effect.
2	UNPAUSE			Used to unpauses the TCP.
		DEFAULT	0	No effect.
		UNPAUSE	1	Unpause TCP.
1	PAUSE			Used to pause the TCP.
		DEFAULT	0	No effect.
		PAUSE	1	Pause TCP.
0	START			Used to start the TCP.
		DEFAULT	0	No effect.
		START	1	Start TCP.

[†] For CSL implementation, use the notation TCP_EXE_field_symval

B.17.15 TCP Endian Register (TCPEND)

The TCP endian register (TCPEND) is shown in Figure B–267 and described in Table B–278. TCPEND should only be used when the DSP is set to *big-endian mode*.

Figure B–267. TCP Endian Register (TCPEND)

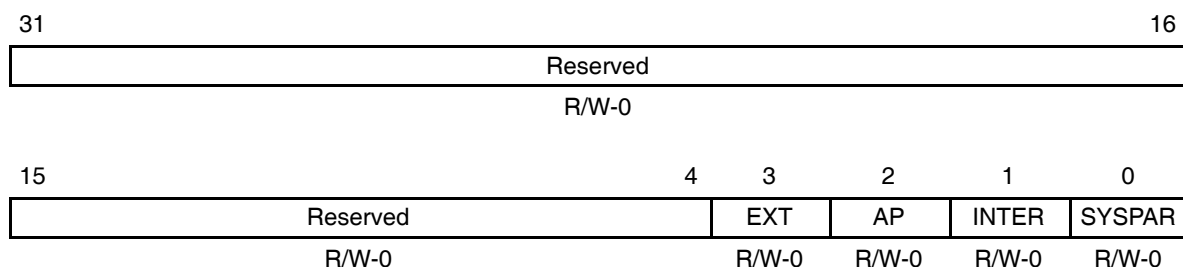

Legend: R/W = Read/Write; -n = value after reset

Table B–278. TCP Endian Register (TCPEND) Field Values

Bit	field†	symval†	Value	Description
31–4	Reserved	–	0	Reserved. The reserved bit location is always read as 0. A value written to this field has no effect.
3	EXT			Extrinsics memory format.
		32BIT	0	32-bit word packed
		NATIVE	1	Native format (7 bits logically right aligned on 8 bits)
2	AP			A prioris memory format.
		32BIT	0	32-bit word packed
		NATIVE	1	Native format (7 bits logically right aligned on 8 bits)
1	INTER			Interleaver indexes memory format.
		32BIT	0	32-bit word packed
		NATIVE	1	Native format (16 bits)
0	SYSPAR			Systematics and parities memory format.
		32BIT	0	32-bit word packed
		NATIVE	1	Native format (8 bits)

† For CSL implementation, use the notation TCP_END_field_symval

B.17.16 TCP Error Register (TCPERR)

The TCP error register (TCPERR) is shown in Figure B–268 and described in Table B–279.

Figure B–268. TCP Error Register (TCPERR)

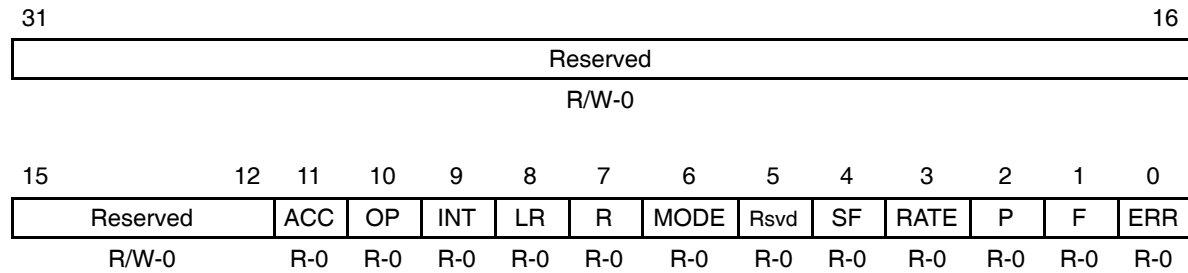

Legend: R = Read only; R/W = Read/Write; -n = value after reset

Table B–279. TCP Error Register (TCPERR) Field Values

Bit	field [†]	symval [†]	Value	Description
31–12	Reserved	–	0	Reserved. The reserved bit location is always read as 0. A value written to this field has no effect.
11	ACC			Memory access error bit.
		NO	0	No error.
		YES	1	TCP memories access not allowed in current state.
10	OP			Output parameters load error bit.
		NO	0	No error.
		YES	1	Output parameters load bit set to 1 in SP mode.
9	INT			Interleaver table load error bit.
		NO	0	No error.
		YES	1	Interleaver load bit set to 1 in SP mode.
8	LR			Last subframe reliability length error bit.
		NO	0	No error.
		YES	1	Last subframe reliability length < 40

[†] For CSL implementation, use the notation TCP_ERR_field_symval

Table B–279. TCP Error Register (TCPERR) Field Values (Continued)

Bit	field [†]	symval [†]	Value	Description
7	R			Reliability length error bit.
		NO	0	No error.
		YES	1	Reliability length < 40
6	MODE			Operational mode error bit.
		NO	0	No error.
		YES	1	Operational mode is different from 4, 5, and 7.
5	Reserved	–	0	Reserved. The reserved bit location is always read as 0. A value written to this field has no effect.
4	SF			Subframe length error bit.
		NO	0	No error.
		YES	1	Subframe length > 5114.
3	RATE			Rate error bit.
		NO	0	No error.
		YES	1	Rate different from 1/2, 1/3, and 1/4.
2	P			Prolog length error bit.
		NO	0	No error.
		YES	1	Prolog length > 48.
1	F			Frame length error bit.
		NO	0	No error.
		YES	1	In SA mode frame length > 5114 or frame length < 40. In SP mode, frame length >20730 or frame length < 40.
0	ERR			Error bit.
		NO	0	No error.
		YES	1	Error has occurred.

[†] For CSL implementation, use the notation TCP_ERR_field_symval

B.17.17 TCP Status Register (TCPSTAT)

The TCP status register (TCPSTAT) is shown in Figure B–269 and described in Table B–280.

Figure B–269. TCP Status Register (TCPSTAT)

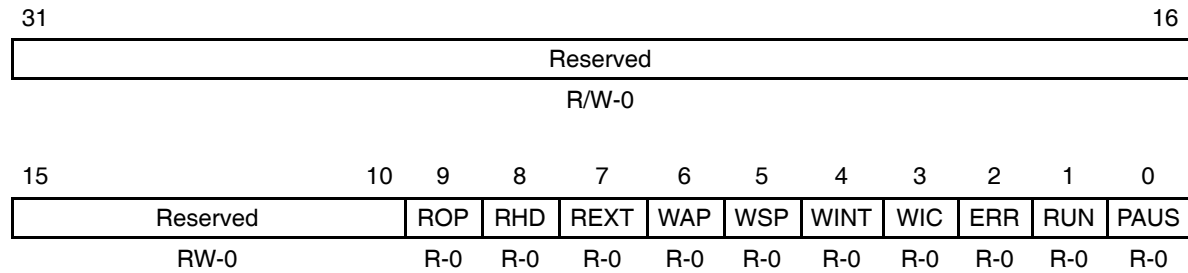

Legend: R = Read only; R/W = Read/Write; -n = value after reset

Table B–280. TCP Status Register (TCPSTAT) Field Values

Bit	field [†]	symval [†]	Value	Description
31–10	Reserved	–	0	Reserved. The reserved bit location is always read as 0. A value written to this field has no effect.
9	ROP			Defines if the TCP is waiting for output parameter data to be read.
		NREADY	0	Not waiting
		READY	1	Waiting
8	RHD			Defines if the TCP is waiting for hard decision data to be read.
		NREADY	0	Not waiting
		READY	1	Waiting
7	REXT			Defines if the TCP is waiting for extrinsic data to be read.
		NREADY	0	Not waiting
		READY	1	Waiting
6	WAP			Defines if the TCP is waiting for a priori data to be written.
		NREADY	0	Not waiting
		READY	1	Waiting

[†] For CSL implementation, use the notation TCP_STAT_field_symval

Table B–280. TCP Status Register (TCPSTAT) Field Values (Continued)

Bit	field [†]	symval [†]	Value	Description
5	WSP			Defines if the TCP is waiting for systematic and parity data to be written.
		NREADY	0	Not waiting
		READY	1	Waiting
4	WINT			Defines if the TCP is waiting for interleaver indexes to be written.
		NREADY	0	Not waiting
		READY	1	Waiting
3	WIC			Defines if the TCP is waiting for input control words to be written.
		NREADY	0	Not waiting
		READY	1	Waiting
2	ERR			Defines if the TCP has encountered an error.
		NO	0	No error.
		YES	1	Error
1	RUN			Defines if the TCP is running.
		NO	0	Not running.
		YES	1	Running.
0	PAUS			Defines if the TCP is paused.
		NO	0	No activity – waiting for start instruction
		YES	1	Paused

[†] For CSL implementation, use the notation TCP_STAT_field_symval

B.18 Timer Registers

Table B–281. Timer Registers

Acronym	Register Name	Section
CTL	Timer control register	B.18.1
PRD	Timer period register	B.18.2
CNT	Timer count register	B.18.3

B.18.1 Timer Control Register (CTL)

Figure B–270. Timer Control Register (CTL)

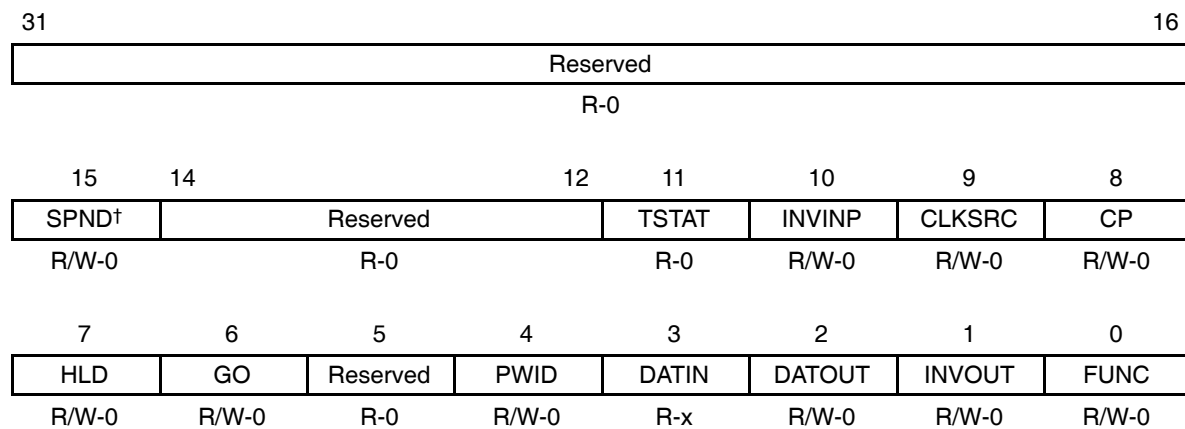

Legend: R = Read only; R/W = Read/Write; -n = value after reset; -x = value is indeterminate after reset

† For C64x DSP only; for C621x/C671x DSP, this bit is reserved.

Table B–282. Timer Control Register (CTL) Field Values

Bit	field [†]	symval [†]	Value	Description
31–16	Reserved	–	0	Reserved. The reserved bit location is always read as 0. A value written to this field has no effect.
15	SPND [‡]			Suspend mode bit. Stops timer from counting during an emulation halt. Only affects operation if the clock source is internal, CLKSRC = 1. Reads always return a 0.
		EMURUN	0	Timer continues counting during an emulation halt.
		EMUSTOP	1	Timer stops counting during an emulation halt.
14–12	Reserved	–	0	Reserved. The reserved bit location is always read as 0. A value written to this field has no effect.
11	TSTAT			Timer status bit. Value of timer output.
		0	0	
		1	1	
10	INVINP			TINP inverter control bit. Only affects operation if CLKSRC = 0.
		NO	0	Noninverted TINP drives timer.
		YES	1	Inverted TINP drives timer.
9	CLKSRC			Timer input clock source bit.
		EXTERNAL	0	External clock source drives the TINP pin.
		CUPOVR4	1	For C62x/C67x DSP: Internal clock source. CPU clock/4
	CUPOVR8	1	For C64x DSP: Internal clock source. CPU clock/8	
8	CP			Clock/pulse mode enable bit.
		PULSE	0	Pulse mode. TSTAT is active one CPU clock after the timer reaches the timer period. PWID determines when it goes inactive.
		CLOCK	1	Clock mode. TSTAT has a 50% duty cycle with each high and low period one countdown period wide.

[†] For CSL implementation, use the notation `TIMER_CTL_field_symval`

[‡] For C64x DSP only; for C621x/C671x DSP, this bit is reserved.

Table B–282. Timer Control Register (CTL) Field Values (Continued)

Bit	field [†]	symval [†]	Value	Description
7	HLD			Hold bit. Counter may be read or written regardless of HLD value.
		YES	0	Counter is disabled and held in the current state.
		NO	1	Counter is allowed to count.
6	GO			GO bit. Resets and starts the timer counter.
		NO	0	No effect on the timers.
		YES	1	If HLD = 1, the counter register is zeroed and begins counting on the next clock.
5	Reserved	–	0	Reserved. The reserved bit location is always read as 0. A value written to this field has no effect.
4	PWID			Pulse width bit. Only used in pulse mode (CP = 0).
		ONE	0	TSTAT goes inactive one timer input clock cycle after the timer counter value equals the timer period value.
		TWO	1	TSTAT goes inactive two timer input clock cycles after the timer counter value equals the timer period value.
3	DATIN			Data in bit. Value on TINP pin.
		0	0	Value on TINP pin is logic low.
		1	1	Value on TINP pin is logic high.
2	DATOUT			Data output bit.
		0	0	DATOUT is driven on TOUT.
		1	1	TSTAT is driven on TOUT after inversion by INVOUT.
1	INVOUT			TOUT inverter control bit (used only if FUNC = 1).
		NO	0	Noninverted TSTAT drives TOUT.
		YES	1	Inverted TSTAT drives TOUT.
0	FUNC			Function of TOUT pin.
		GPIO	0	TOUT is a general-purpose output pin.
		TOUT	1	TOUT is a timer output pin.

[†] For CSL implementation, use the notation `TIMER_CTL_field_symval`

[‡] For C64x DSP only; for C621x/C671x DSP, this bit is reserved.

B.18.2 Timer Period Register (PRD)

Figure B–271. Timer Period Register (PRD)

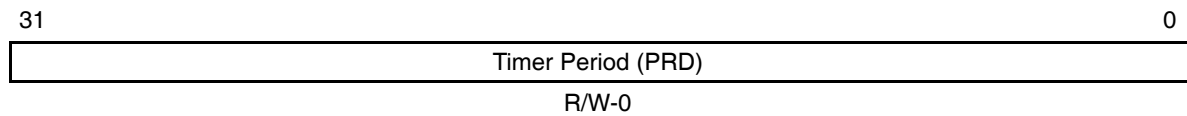

Legend: R/W-x = Read/Write-Reset value

Table B–283. Timer Period Register (PRD) Field Values

Bit	Field	<i>symval</i> [†]	Value	Description
31–0	PRD	OF(<i>value</i>)	0–FFFF FFFFh	Period bits. This 32-bit value is the number of timer input clock cycles to count and is used to reload the timer count register (CNT). This number controls the frequency of the timer output status bit (TSTAT).

[†] For CSL implementation, use the notation `TIMER_PRD_PRD_symval`

B.18.3 Timer Count Register (CNT)

Figure B–272. Timer Count Register (CNT)

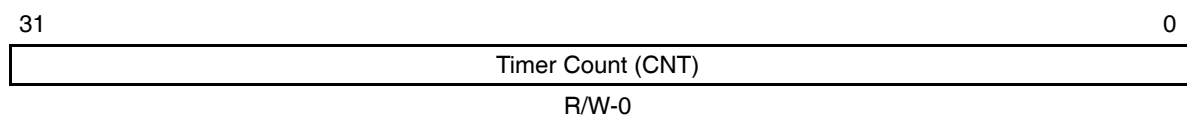

Legend: R/W-x = Read/Write-Reset value

Table B–284. Timer Count Register (CNT) Field Values

Bit	Field	<i>symval</i> [†]	Value	Description
31–0	CNT	OF(<i>value</i>)	0–FFFF FFFFh	Main count bits. This 32-bit value is the current count of the main counter. This value is incremented by 1 every input clock cycle.

[†] For CSL implementation, use the notation `TIMER_CNT_CNT_symval`

B.19 UTOPIA Registers

The UTOPIA port is configured via the configuration registers listed in Table B–285. See the device-specific datasheet for the memory address of these registers.

Table B–285. UTOPIA Configuration Registers

Acronym	Register Name	Section
UCR	UTOPIA Control Register	B.19.1
UIER	UTOPIA Interrupt Enable Register	B.19.2
UIPR	UTOPIA Interrupt Pending Register	B.19.3
CDR	Clock Detect Register	B.19.4
EIER	Error Interrupt Enable Register	B.19.5
EIPR	Error Interrupt Pending Register	B.19.6

B.19.1 UTOPIA Control Register (UCR)

The UTOPIA interface is configured via the UTOPIA control register (UCR) and contains UTOPIA status and control bits. The UCR is shown in Figure B–273 and described in Table B–286.

Figure B–273. UTOPIA Control Register (UCR)

31	30	29	28	24	23	22	21	18	17	16
BEND	Reserved	SLID		Reserved	XUDC			Rsvd	UXEN	
R/W-0	R-0	R/W-0		R-0	R/W-0			R-0	R/W-0	
15	14	13				6	5	2	1	0
Rsvd	MPHY	Reserved			RUDC			Rsvd	UREN	
R-0	R/W-0	R-0			R/W-0			R-0	R/W-0	

Legend: R = Read only; R/W = Read/Write; -n = value after reset

Table B–286. UTOPIA Control Register (UCR) Field Values

Bit	field [†]	symval [†]	Value	Description
31	BEND			Big-endian mode enable bit for data transferred by way of the UTOPIA interface.
		LITTLE	0	Data is assembled to conform to little-endian format.
		BIG	1	Data is assembled to conform to big-endian format.
30–29	Reserved	–	0	Reserved. The reserved bit location always returns the default value. A value written to this field has no effect. If writing to this field, always write the default value for future device compatibility.
28–24	SLID	OF(<i>value</i>)	0–1Fh	Slave ID bits. Applicable in MPHY mode. This 5-bit value is used to identify the UTOPIA in a MPHY set up. Does not apply to single-PHY slave operation.
23–22	Reserved	–	0	Reserved. The reserved bit location always returns the default value. A value written to this field has no effect. If writing to this field, always write the default value for future device compatibility.
21–18	XUDC	OF(<i>value</i>)	0–Fh	Transmit user-defined cell bits. Valid values are 0 to 11, the remaining values are reserved.
		DEFAULT	0	XUDC feature is disabled. The UTOPIA interface transmits a normal ATM cell of 53 bytes.
			1h–Bh	UTOPIA interface transmits the programmed number (1 to 11) of bytes as extra header. A UDC may have a minimum of 54 bytes (XUDC = 1h) up to a maximum of 64 bytes (XUDC = Bh).
		–	Ch–Fh	Reserved
17	Reserved	–	0	Reserved. The reserved bit location always returns the default value. A value written to this field has no effect. If writing to this field, always write the default value for future device compatibility.
16	UXEN			UTOPIA transmitter enable bit.
		DISABLE	0	UTOPIA port transmitter is disabled and in reset state.
		ENABLE	1	UTOPIA port transmitter is enabled.
15	Reserved	–	0	Reserved. The reserved bit location always returns the default value. A value written to this field has no effect. If writing to this field, always write the default value for future device compatibility.

[†] For CSL implementation, use the notation `UTOP_UCR_field_symval`

Table B–286. UTOPIA Control Register (UCR) Field Values (Continued)

Bit	field [†]	symval [†]	Value	Description
14	MPHY			UTOPIA receive/transmit multi-PHY mode enable bit.
		SINGLE	0	Single PHY mode is selected for receive and transmit UTOPIA.
		MULTI	1	Multi-PHY mode is selected for receive and transmit UTOPIA.
13–6	Reserved	–	0	Reserved. The reserved bit location always returns the default value. A value written to this field has no effect. If writing to this field, always write the default value for future device compatibility.
5–2	RUDC	OF(<i>value</i>)	0–Fh	Receive user-defined cell bits. Valid values are 0 to 11, the remaining values are reserved.
		DEFAULT	0	RUDC feature is disabled. The UTOPIA interface expects a normal ATM cell of 53 bytes.
			1h–Bh	UTOPIA interface expects to receive the programmed number (1 to 11) of bytes as extra header. A UDC may have a minimum of 54 bytes (RUDC = 1h) up to a maximum of 64 bytes (RUDC = Bh).
		–	Ch–Fh	Reserved
1	Reserved	–	0	Reserved. The reserved bit location always returns the default value. A value written to this field has no effect. If writing to this field, always write the default value for future device compatibility.
0	UREN			UTOPIA receiver enable bit.
		DISABLE	0	UTOPIA port receiver is disabled and in reset state.
		ENABLE	1	UTOPIA port receiver is enabled.

[†] For CSL implementation, use the notation `UTOP_UCR_field_symval`

B.19.2 UTOPIA Interrupt Enable Register (UIER)

The relevant interrupts for each queue are enabled in the UTOPIA interrupt enable register (UIER). The UIER is shown in Figure B–274 and described in Table B–287.

Figure B–274. UTOPIA Interrupt Enable Register (UIER)

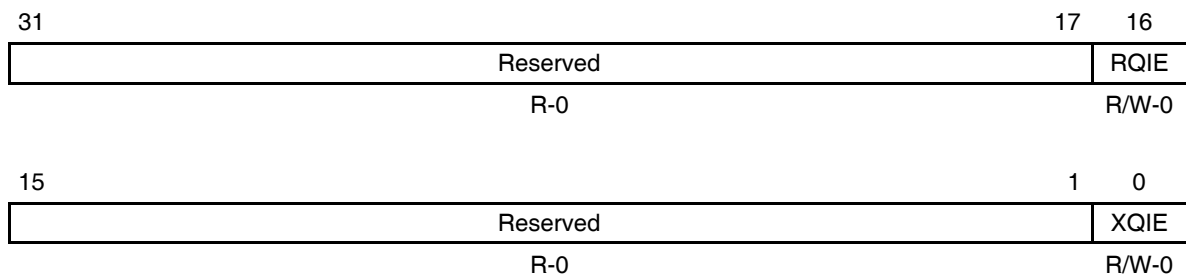

Legend: R = Read only; R/W = Read/Write; -n = value after reset

Table B–287. UTOPIA Interrupt Enable Register (UIER) Field Values

Bit	<i>field</i> [†]	<i>symval</i> [†]	Value	Description
31–17	Reserved	–	0	Reserved. The reserved bit location always returns the default value. A value written to this field has no effect. If writing to this field, always write the default value for future device compatibility.
16	RQIE	OF(<i>value</i>)	0	Receive queue interrupt enable bit.
		DEFAULT	0	Receive queue interrupt is disabled. No interrupts are sent to the CPU upon the UREVT event.
			1	Receive queue interrupt is enabled. Upon UREVT, interrupt UINT is sent to the CPU interrupt selector.
15–1	Reserved	–	0	Reserved. The reserved bit location always returns the default value. A value written to this field has no effect. If writing to this field, always write the default value for future device compatibility.
0	XQIE	OF(<i>value</i>)	0	Transmit queue interrupt enable bit.
		DEFAULT	0	Transmit queue interrupt is disabled. No interrupts are sent to the CPU upon the UXEVT event.
			1	Transmit queue interrupt is enabled. Upon UXEVT, interrupt UINT is sent to the CPU interrupt selector.

[†] For CSL implementation, use the notation `UTOP_UIER_field_symval`

B.19.3 UTOPIA Interrupt Pending Register (UIPR)

Interrupts are captured in the UTOPIA interrupt pending register (UIPR). The UIPR is shown in Figure B–275 and described in Table B–288.

Figure B–275. UTOPIA Interrupt Pending Register (UIPR)

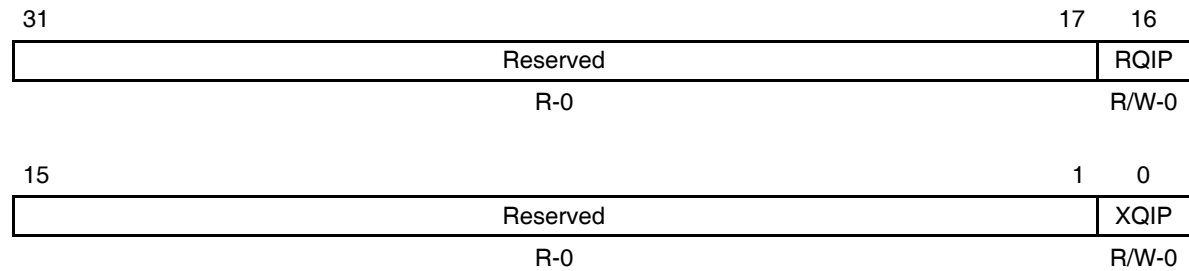

Legend: R = Read only; R/W = Read/Write; -n = value after reset

Table B–288. UTOPIA Interrupt Pending Register (UIPR) Field Values

Bit	field [†]	symval [†]	Value	Description
31–17	Reserved	–	0	Reserved. The reserved bit location always returns the default value. A value written to this field has no effect. If writing to this field, always write the default value for future device compatibility.
16	RQIP			Receive queue interrupt pending bit.
		DEFAULT	0	No receive queue interrupt is pending.
		CLEAR	1	Receive queue interrupt is pending.
15–1	Reserved	–	0	Reserved. The reserved bit location always returns the default value. A value written to this field has no effect. If writing to this field, always write the default value for future device compatibility.
0	XQIP			Transmit queue interrupt pending bit.
		DEFAULT	0	No transmit queue interrupt is pending.
		CLEAR	1	Transmit queue interrupt is pending.

[†] For CSL implementation, use the notation `UTOP_UIPR_field_symval`

B.19.4 Clock Detect Register (CDR)

The clock detect register (CDR) and the UTOPIA clock detection feature allows the DSP to detect the presence of the URCLK and/or UXCLK. The CDR is shown in Figure B–276 and described in Table B–289.

If a URCLK or a UXCLK edge is not detected within the respective time period specified in CDR, an error bit, RCFP or XCFP, respectively, is set in the error interrupt pending register (EIPR). In addition, the RCPP and XCPP bits in EIPR indicate the presence of the URCLK and UXCLK, respectively.

Figure B–276. Clock Detect Register (CDR)

31	24 23	16
Reserved	XCCNT	
R-0	R/W-FFh	
15	8 7	0
Reserved	RCCNT	
R-0	R/W-FFh	

Legend: R = Read only; R/W = Read/Write; -n = value after reset

Table B–289. Clock Detect Register (CDR) Field Values

Bit	field [†]	symval [†]	Value	Description
31–24	Reserved	–	0	Reserved. The reserved bit location always returns the default value. A value written to this field has no effect. If writing to this field, always write the default value for future device compatibility.
23–16	XCCNT	OF(value)	0–FFh	Transmit clock count bits specify the number of peripheral clock cycles that the external UTOPIA transmit clock (UXCLK) must have a low-to-high transition to avoid a reset of the transmit interface.
			0	Transmit clock detect feature is disabled.
			1h–FFh	Transmit clock detect feature is enabled. This 8-bit value is the number of peripheral clock cycles before the next UTOPIA clock edge (UXCLK) must be present. If a UXCLK clock edge is undetected within XCCNT peripheral clock cycles, the transmit UTOPIA port is reset by hardware. The XCF error bit (XCFP) in the error interrupt pending register (EIPR) is set.
	DEFAULT		FFh	

[†] For CSL implementation, use the notation UTOP_CDR_field_symval

Table B–289. Clock Detect Register (CDR) Field Values (Continued)

Bit	field [†]	symval [†]	Value	Description
15–8	Reserved	–	0	Reserved. The reserved bit location always returns the default value. A value written to this field has no effect. If writing to this field, always write the default value for future device compatibility.
7–0	RCCNT	OF(value)	0–FFh	Receive clock count bits specify the number of peripheral clock cycles that the external UTOPIA receive clock must have a low-to-high transition to avoid a reset of the receive interface.
			0	Receive clock detect feature is disabled.
			1h–FFh	Receive clock detect feature is enabled. This 8-bit value is the number of peripheral clock cycles before the next UTOPIA clock edge (URCLK) must be present. If a URCLK clock edge is undetected within RCCNT peripheral clock cycles, the receive UTOPIA port is reset by hardware. The RCF error bit (RCFP) in the error interrupt pending register (EIPR) is set.
		DEFAULT	FFh	

[†] For CSL implementation, use the notation `UTOP_CDR_field_symval`

B.19.5 Error Interrupt Enable Register (EIER)

If an error condition is set in the error interrupt enable register (EIER) and the corresponding error is set in the error interrupt pending register (EIPR), an interrupt is generated to the CPU. The EIER is shown in Figure B–277 and described in Table B–290.

Figure B–277. Error Interrupt Enable Registers (EIER)

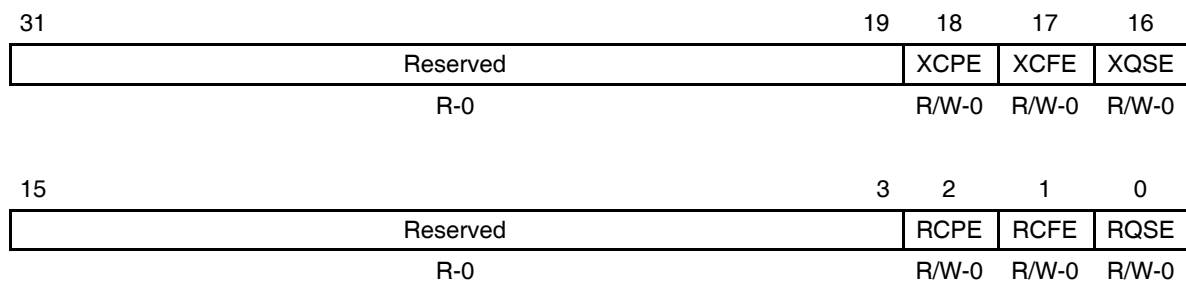

Legend: R = Read only; R/W = Read/Write; -n = value after reset

Table B–290. Error Interrupt Enable Register (EIER) Field Values

Bit	field [†]	symval [†]	Value	Description
31–19	Reserved	–	0	Reserved. The reserved bit location always returns the default value. A value written to this field has no effect. If writing to this field, always write the default value for future device compatibility.
18	XCPE			Transmit clock present interrupt enable bit.
		DISABLE	0	Transmit clock present interrupt is disabled.
		ENABLE	1	Transmit clock present interrupt is enabled.
17	XCFE			Transmit clock failed interrupt enable bit.
		DISABLE	0	Transmit clock failed interrupt is disabled.
		ENABLE	1	Transmit clock failed interrupt is enabled.
16	XQSE			Transmit queue stall interrupt enable bit.
		DISABLE	0	Transmit queue stall interrupt is disabled.
		ENABLE	1	Transmit queue stall interrupt is enabled.
15–3	Reserved	–	0	Reserved. The reserved bit location always returns the default value. A value written to this field has no effect. If writing to this field, always write the default value for future device compatibility.
2	RCPE			Receive clock present interrupt enable bit.
		DISABLE	0	Receive clock present interrupt is disabled.
		ENABLE	1	Receive clock present interrupt is enabled.
1	RCFE			Receive clock failed interrupt enable bit.
		DISABLE	0	Receive clock failed interrupt is disabled.
		ENABLE	1	Receive clock failed interrupt is enabled.
0	RQSE			Receive queue stall interrupt enable bit.
		DISABLE	0	Receive queue stall interrupt is disabled.
		ENABLE	1	Receive queue stall interrupt is enabled.

[†] For CSL implementation, use the notation `UTOP_EIER_field_symval`

B.19.6 Error Interrupt Pending Register (EIPR)

The UTOPIA error conditions are recorded in the error interrupt pending register (EIPR). The EIPR is shown in Figure B–278 and described in Table B–291. A write of 1 to the XCPP, XCFP, RCPP, or RCFP bit clears the corresponding bit. A write of 0 has no effect. The XQSP and RQSP bits are read-only bits and are cleared automatically by the UTOPIA interface once the error conditions cease. The error conditions in EIPR can generate an interrupt to the CPU, if the corresponding bits are set in the error interrupt enable register (EIER).

Figure B–278. Error Interrupt Pending Register (EIPR)

31		19	18	17	16
Reserved			XCPP	XCFP	XQSP
R-0			R/W-0	R/W-0	R-0
15		3	2	1	0
Reserved			RCPP	RCFP	RQSP
R-0			R/W-0	R/W-0	R-0

Legend: R = Read only; R/W = Read/Write; -n = value after reset

Table B–291. Error Interrupt Pending Register (EIPR) Field Values

Bit	field [†]	symval [†]	Value	Description
31–19	Reserved	–	0	Reserved. The reserved bit location always returns the default value. A value written to this field has no effect. If writing to this field, always write the default value for future device compatibility.
18	XCPP	DEFAULT	0	UXCLK is not present.
		CLEAR	1	UXCLK is present. If the corresponding bit in EIER is set, an interrupt UINT is sent to the CPU.
17	XCFP	DEFAULT	0	UXCLK is present.
		CLEAR	1	UXCLK failed. No UXCLK is detected for a period longer than that specified in the XCCNT field of CDR. If the corresponding bit in EIER is set, an interrupt UINT is sent to the CPU.

[†] For CSL implementation, use the notation `UTOP_EIPR_field_symval`

Table B–291. Error Interrupt Pending Register (EIPR) Field Values (Continued)

Bit	field [†]	symval [†]	Value	Description
16	XQSP	OF(<i>value</i>)		Transmit queue stall interrupt pending bit.
		DEFAULT	0	No transmit queue stall condition.
			1	Transmit queue stalled, a write is performed to a full transmit queue. The write is stalled until the queue is drained and space is available. Data is not overwritten. XQSP is cleared once the queue has space available and writes can continue.
15–3	Reserved	–	0	Reserved. The reserved bit location always returns the default value. A value written to this field has no effect. If writing to this field, always write the default value for future device compatibility.
2	RCPP			Receive clock present interrupt pending bit indicates if the UTOPIA receive clock (URCLK) is present. RCPP is valid regardless if the receive interface is enabled or disabled.
		DEFAULT	0	URCLK is not present.
		CLEAR	1	URCLK is present. If the corresponding bit in EIER is set, an interrupt UINT is sent to the CPU.
1	RCFP			Receive clock failed interrupt pending bit is activated only when the UTOPIA receive interface is enabled (UREN in UCR = 1).
		DEFAULT	0	URCLK is present.
		CLEAR	1	URCLK failed. No URCLK is detected for a period longer than that specified in the RCCNT field of CDR. If the corresponding bit in EIER is set, an interrupt UINT is sent to the CPU.
0	RQSP	OF(<i>value</i>)		Receive queue stall interrupt pending bit.
		DEFAULT	0	No receive queue stall condition.
			1	Receive queue stalled, a read is performed from an empty receive queue. The read is stalled until valid data is available in the queue. RQSP is cleared as soon as valid data is available and the read is performed.

[†] For CSL implementation, use the notation `UTOP_EIPR_field_symval`

B.20 VCP Registers

The VCP contains several memory-mapped registers accessible via CPU load and store instructions, the QDMA, and the EDMA. A peripheral-bus access is faster than an EDMA-bus access for isolated accesses (typically when accessing control registers). EDMA-bus accesses are intended to be used for EDMA transfers and are meant to provide maximum throughput to/from the VCP.

The memory map is listed in Table B–292. The branch metric and decision memories contents are not accessible and the memories can be regarded as FIFOs by the DSP, meaning you do not have to perform any indexing on the addresses.

Table B–292. EDMA Bus Accesses Memory Map

Start Address (hex)		Acronym	Register Name	Section
EDMA bus	Peripheral Bus			
5000 0000	01B8 0000	VCPIC0	VCP Input Configuration Register 0	B.20.1
5000 0004	01B8 0004	VCPIC1	VCP Input Configuration Register 1	B.20.2
5000 0008	01B8 0008	VCPIC2	VCP Input Configuration Register 2	B.20.3
5000 000C	01B8 000C	VCPIC3	VCP Input Configuration Register 3	B.20.4
5000 0010	01B8 0010	VCPIC4	VCP Input Configuration Register 4	B.20.5
5000 0014	01B8 0014	VCPIC5	VCP Input Configuration Register 5	B.20.6
5000 0048	01B8 0048	VCPOUT0	VCP Output Register 0	B.20.7
5000 004C	01B8 004C	VCPOUT1	VCP Output Register 1	B.20.8
5000 0080	–	VCPWBM	VCP Branch Metrics Write Register	–
5000 0088	–	VCPRDECS	VCP Decisions Read Register	–
–	01B8 0018	VCPEXE	VCP Execution Register	B.20.9
–	01B8 0020	VCPEND	VCP Endian Mode Register	B.20.10
–	01B8 0040	VCPSTAT0	VCP Status Register 0	B.20.11
–	01B8 0044	VCPSTAT1	VCP Status Register 1	B.20.12
–	01B8 0050	VCPEERR	VCP Error Register	B.20.13

B.20.1 VCP Input Configuration Register 0 (VCPIC0)

The VCP input configuration register 0 (VCPIC0) is shown in Figure B-279 and described in Table B-293.

Figure B-279. VCP Input Configuration Register 0 (VCPIC0)

31	24	23	16	15	8	7	0
POLY3		POLY2		POLY1		POLY0	
R/W-0		R/W-0		R/W-0		R/W-0	

Legend: R/W = Read/write; -n = value after reset

Table B-293. VCP Input Configuration Register 0 (VCPIC0) Field Values

Bit	field [†]	symval [†]	Value	Description [‡]
31-24	POLY3	OF(value)	0-FFh	Polynomial generator G_3 .
23-16	POLY2	OF(value)	0-FFh	Polynomial generator G_2 .
15-8	POLY1	OF(value)	0-FFh	Polynomial generator G_1 .
7-0	POLY0	OF(value)	0-FFh	Polynomial generator G_0 .

[†] For CSL implementation, use the notation VCP_IC0_POLYn_symval

[‡] The polynomial generators are 9-bit values defined as $G(z) = b_8z^{-8} + b_7z^{-7} + b_6z^{-6} + b_5z^{-5} + b_4z^{-4} + b_3z^{-3} + b_2z^{-2} + b_1z^{-1} + b_0$, but only 8 bits are passed in the POLYn bitfields so that b_1 is the most significant bit and b_8 the least significant bit (b_0 is not passed but set to 1 by the internal VCP hardware).

B.20.2 VCP Input Configuration Register 1 (VCPIC1)

The VCP input configuration register 1 (VCPIC1) is shown in Figure B–280 and described in Table B–294.

Figure B–280. VCP Input Configuration Register 1 (VCPIC1)

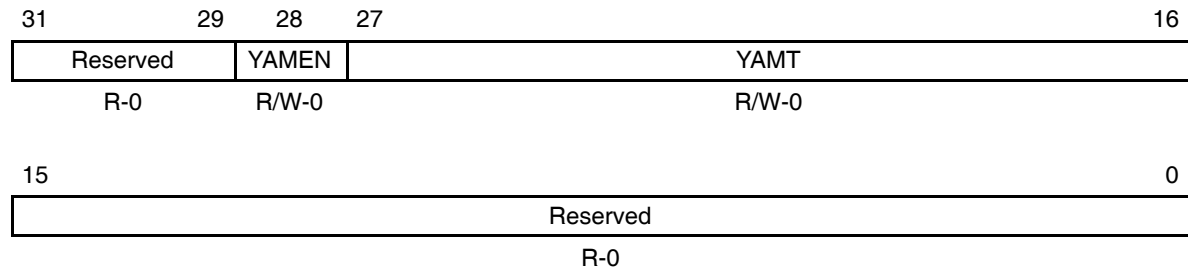

Legend: R/W = Read/write; -n = value after reset

Table B–294. VCP Input Configuration Register 1 (VCPIC1) Field Values

Bit	field [†]	symval [†]	Value	Description
31–29	Reserved	–	0	Reserved. The reserved bit location is always read as 0. A value written to this field has no effect.
28	YAMEN			Yamamoto algorithm enable bit.
		DISABLE	0	Yamamoto algorithm is disabled.
		ENABLE	1	Yamamoto algorithm is enabled.
27–16	YAMT	OF(value)	0–FFFh	Yamamoto threshold value bits.
15–0	Reserved	–	0	Reserved. These Reserved bit locations must be 0. A value written to this field has no effect.

[†] For CSL implementation, use the notation VCP_IC1_field_symval

B.20.3 VCP Input Configuration Register 2 (VCPIC2)

The VCP input configuration register 2 (VCPIC2) is shown in Figure B–281 and described in Table B–295.

Figure B–281. VCP Input Configuration Register 2 (VCPIC2)

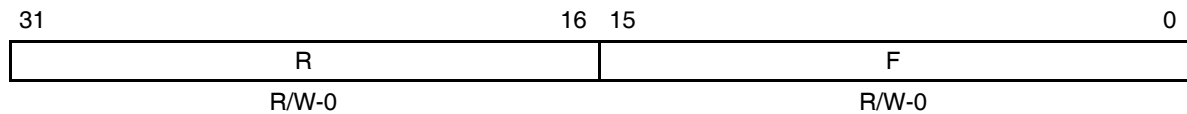

Legend: R/W = Read/write; -n = value after reset

Table B–295. VCP Input Configuration Register 2 (VCPIC2) Field Values

Bit	field [†]	symval [†]	Value	Description
31–16	R	OF(value)	0–FFFFh	Reliability length bits.
15–0	F	OF(value)	0–FFFFh	Frame length bits.

[†] For CSL implementation, use the notation VCP_IC2_field_symval

B.20.4 VCP Input Configuration Register 3 (VCPIC3)

The VCP input configuration register 3 (VCPIC3) is shown in Figure B–282 and described in Table B–296.

Figure B–282. VCP Input Configuration Register 3 (VCPIC3)

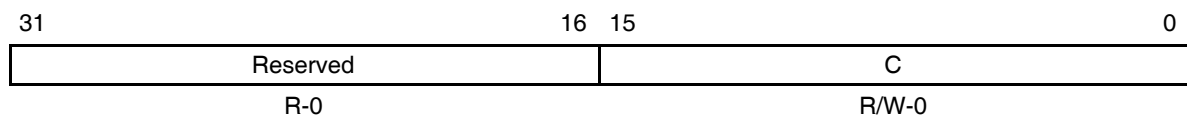

Legend: R/W = Read/write; -n = value after reset

Table B–296. VCP Input Configuration Register 3 (VCPIC3) Field Values

Bit	Field	symval [†]	Value	Description
31–16	Reserved	–	0	Reserved. The reserved bit location is always read as 0. A value written to this field has no effect.
15–0	C	OF(value)	0–FFFFh	Convergence distance bits.

[†] For CSL implementation, use the notation VCP_IC3_C_symval

B.20.5 VCP Input Configuration Register 4 (VCPIC4)

The VCP input configuration register 4 (VCPIC4) is shown in Figure B–283 and described in Table B–297.

Figure B–283. VCP Input Configuration Register 4 (VCPIC4)

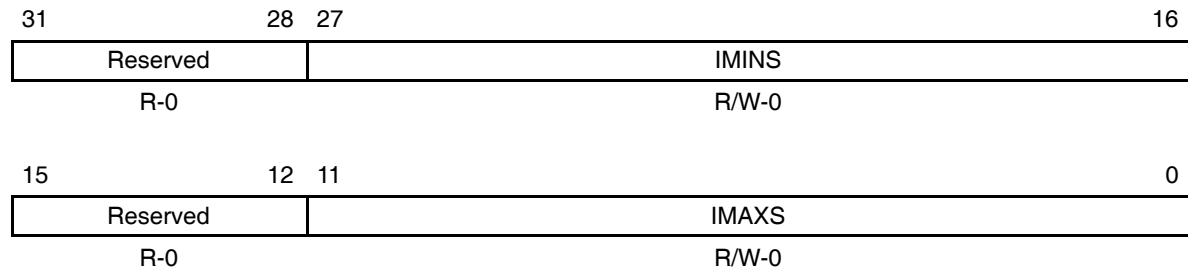

Legend: R/W = Read/write; -n = value after reset

Table B–297. VCP Input Configuration Register 4 (VCPIC4) Field Values

Bit	field [†]	symval [†]	Value	Description
31–28	Reserved	–	0	Reserved. The reserved bit location is always read as 0. A value written to this field has no effect.
27–16	IMINS	OF(value)	0–FFFh	Minimum initial state metric value bits.
15–12	Reserved	–	0	Reserved. The reserved bit location is always read as 0. A value written to this field has no effect.
11–0	IMAXS	OF(value)	0–FFFh	Maximum initial state metric value bits.

[†] For CSL implementation, use the notation VCP_IC4_field_symval

B.20.6 VCP Input Configuration Register 5 (VCPIC5)

The VCP input configuration register 5 (VCPIC5) is shown in Figure B–284 and described in Table B–298.

Figure B–284. VCP Input Configuration Register 5 (VCPIC5)

31	30	29	26	25	24	23	20	19	16
SDHD	OUTF	Reserved			TB		SYMR		SYMX
R/W-0	R/W-0	R-0			R/W-0		R/W-0		R/W-0
				8	7				
Reserved					IMAXI				
R-0					R/W-0				
15									
0									

Legend: R/W = Read/write; -n = value after reset

Table B–298. VCP Input Configuration Register 5 (VCPIC5) Field Values

Bit	field [†]	symval [†]	Value	Description
31	SDHD			Output decision type select bit.
		HARD	0	Hard decisions.
		SOFT	1	Soft decisions.
30	OUTF			Output parameters read flag bit.
		NO	0	VCPREVT is not generated by VCP for output parameters read.
		YES	1	VCPREVT generated by VCP for output parameters read.
29–26	Reserved	–	0	Reserved. The reserved bit location is always read as 0. A value written to this field has no effect.
25–24	TB			Traceback mode select bits.
		NO	0	Not allowed.
		TAIL	1h	Tailed.
		CONV	2h	Convergent.
	MIX		3h	Mixed.
23–20	SYMR	OF(value)	0–Fh	Determines decision buffer length in output FIFO. When programming register values for the SYMR bits, always subtract 1 from the value calculated. Valid values for the SYMR bits are from 0 to Fh.

[†] For CSL implementation, use the notation VCP_IC5_field_symval

Table B–298. VCP Input Configuration Register 5 (VCPIC5) Field Values (Continued)

Bit	field [†]	symval [†]	Value	Description
19–16	SYMX	OF(value)	0–Fh	Determines branch metrics buffer length in input FIFO. When programming register values for the SYMX bits, always subtract 1 from the value calculated. Valid values for the SYMX bits are from 0 to Fh.
15–8	Reserved	–	0	Reserved. The reserved bit location is always read as 0. A value written to this field has no effect.
7–0	IMAXI	OF(value)	0–FFh	Maximum initial state metric value bits. IMAXI bits determine which state should be initialized with the maximum state metrics value (IMAXS) bits in VCPIC4; all the other states will be initialized with the value in the IMINS bits.

[†] For CSL implementation, use the notation VCP_IC5_field_symval

B.20.7 VCP Output Register 0 (VCPOUT0)

The VCP output register 0 (VCPOUT0) is shown in Figure B–285 and described in Table B–299.

Figure B–285. VCP Output Register 0 (VCPOUT0)

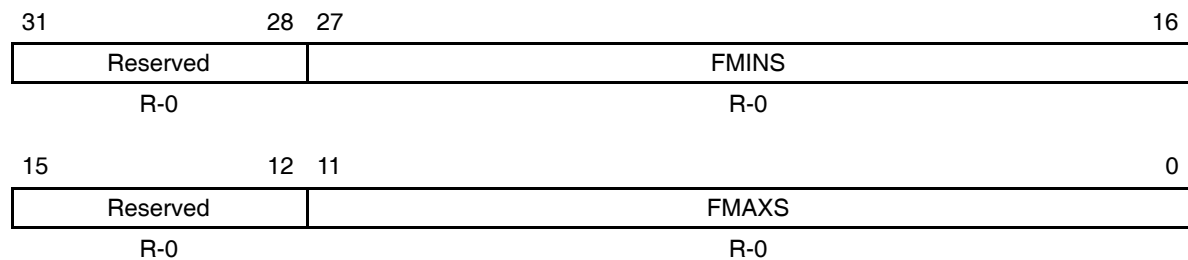

Legend: R = Read only; R/W = Read/Write; -n = value after reset

Table B–299. VCP Output Register 0 (VCPOUT0) Field Values

Bit	field [†]	symval [†]	Value	Description
31–28	Reserved	–	0	Reserved. The reserved bit location is always read as 0. A value written to this field has no effect.
27–16	FMINS	OF(value)	0–FFFh	Final minimum state metric value bits.
15–12	Reserved	–	0	Reserved. The reserved bit location is always read as 0. A value written to this field has no effect.
11–0	FMAXS	OF(value)	0–FFFh	Final maximum state metric value bits.

[†] For CSL implementation, use the notation VCP_OUT0_field_symval

B.20.8 VCP Output Register 1 (VCPOUT1)

The VCP output register 1 (VCPOUT1) is shown in Figure B–286 and described in Table B–300.

Figure B–286. VCP Output Register 1 (VCPOUT1)

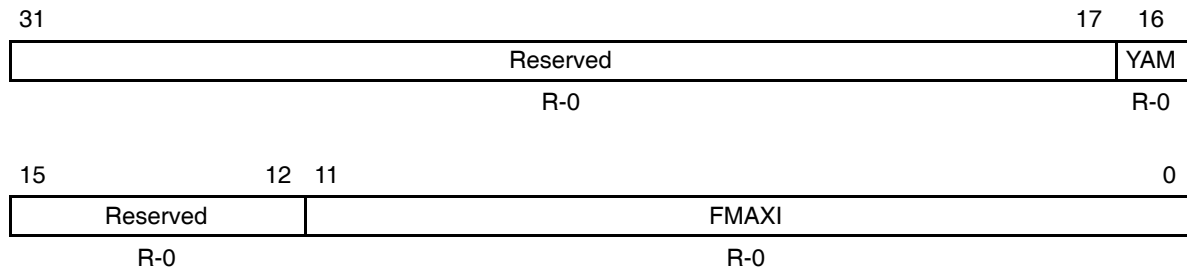

Legend: R = Read only; R/W = Read/Write; -n = value after reset

Table B–300. VCP Output Register 1 (VCPOUT1) Field Values

Bit	field [†]	symval [†]	Value	Description
31–17	Reserved	–	0	Reserved. The reserved bit location is always read as 0. A value written to this field has no effect.
16	YAM			Yamamoto bit result.
		NO	0	
		YES	1	
15–12	Reserved	–	0	Reserved. The reserved bit location is always read as 0. A value written to this field has no effect.
11–0	FMAXI	OF(<i>value</i>)	0–FFFh	State index for the state with the final maximum state metric.

[†] For CSL implementation, use the notation VCP_OUT1_field_symval

B.20.9 VCP Execution Register (VCPEXE)

The VCP execution register (VCPEXE) is shown in Figure B–287 and described in Table B–301.

Figure B–287. VCP Execution Register (VCPEXE)

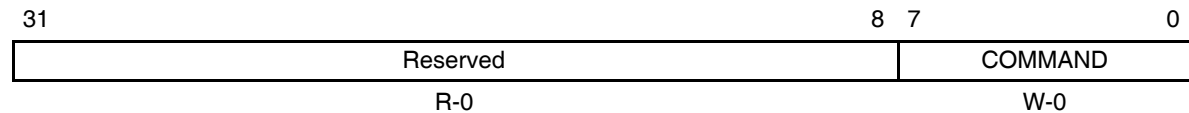

Legend: R/W = Read/write; W = Write only; -n = value after reset

Table B–301. VCP Execution Register (VCPEXE) Field Values

Bit	Field	symval [†]	Value	Description
31–8	Reserved	–	0	Reserved. The reserved bit location is always read as 0. A value written to this field has no effect.
7–0	COMMAND		0–FFh	VCP command select bits.
		DEFAULT	0	Reserved.
		START	1h	Start.
		PAUSE	2h	Pause.
		–	3h	Reserved
		UNPAUSE	4h	Unpause.
		STOP	5h	Stop
		–	6h–FFh	Reserved.

[†] For CSL implementation, use the notation VCP_EXE_COMMAND_symval

B.20.10 VCP Endian Mode Register (VCPEND)

The VCP endian mode register (VCPEND) is shown in Figure B–288 and described in Table B–302. VCPEND has an effect only in big-endian mode.

Figure B–288. VCP Endian Mode Register (VCPEND)

31	Reserved	2	1	0
		SD	BM	
	R-0	R/W-0	R/W-0	

Legend: R/W = Read/write; -n = value after reset

Table B–302. VCP Endian Mode Register (VCPEND) Field Values

Bit	field [†]	symval [†]	Value	Description
31–2	Reserved	–	0	Reserved. The reserved bit location is always read as 0. A value written to this field has no effect.
1	SD			Soft-decisions memory format select bit.
		32BIT	0	32-bit-word packed.
		NATIVE	1	Native format (16 bits).
0	BM			Branch metrics memory format select bit.
		32BIT	0	32-bit-word packed.
		NATIVE	1	Native format (7 bits).

[†] For CSL implementation, use the notation VCP_END_field_symval

B.20.11 VCP Status Register 0 (VCPSTAT0)

The VCP status register 0 (VCPSTAT0) is shown in Figure B–289 and described in Table B–303.

Figure B–289. VCP Status Register 0 (VCPSTAT0)

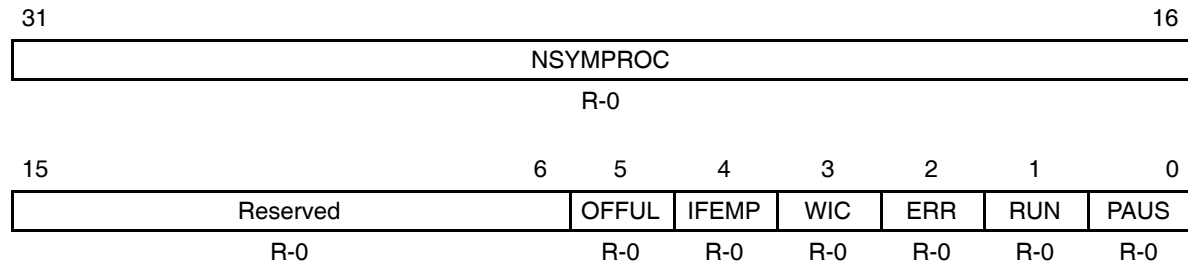

Legend: R = Read only; R/W = Read/Write; -n = value after reset

Table B–303. VCP Status Register 0 (VCPSTAT0) Field Values

Bit	field [†]	symval [†]	Value	Description
31–16	NSYMPROC	OF(value)	0–FFFFh	Number of symbols processed bits. The NSYMPROC bits indicate how many symbols have been processed in the state metric unit.
15–6	Reserved	–	0	Reserved. The reserved bit location is always read as 0. A value written to this field has no effect.
5	OFFFUL			Output FIFO buffer full status bit.
		NO	0	Output FIFO buffer is not full.
		YES	1	Output FIFO buffer is full.
4	IFEMP			Input FIFO buffer empty status bit.
		NO	0	Input FIFO buffer is not empty.
		YES	1	Input FIFO buffer is empty.
3	WIC			Waiting for input configuration bit. The WIC bit indicates that the VCP is waiting for new input control parameters to be written. This bit is always set after decoding of a user channel.
		NO	0	Not waiting for input configuration words.
		YES	1	Waiting for input configuration words.

[†] For CSL implementation, use the notation VCP_STAT0_field_symval

Table B–303. VCP Status Register 0 (VCPSTAT0) Field Values (Continued)

Bit	field [†]	symval [†]	Value	Description
2	ERR			VCP error status bit. The ERR bit is cleared as soon as the DSP reads the VCP error register (VCPERR).
		NO	0	No error.
		YES	1	VCP paused due to error.
1	RUN			VCP running status bit.
		NO	0	VCP is not running.
		YES	1	VCP is running.
0	PAUS			VCP pause status bit.
		NO	0	VCP is not paused. The UNPAUSE command is acknowledged by clearing the PAUS bit.
		YES	1	VCP is paused. The PAUSE command is acknowledged by setting the PAUS bit. The PAUS bit can also be set, if the input FIFO buffer is becoming empty or if the output FIFO buffer is full.

[†] For CSL implementation, use the notation VCP_STAT0_field_symval

B.20.12 VCP Status Register 1 (VCPSTAT1)

The VCP status register 1 (VCPSTAT1) is shown in Figure B–290 and described in Table B–304.

Figure B–290. VCP Status Register 1 (VCPSTAT1)

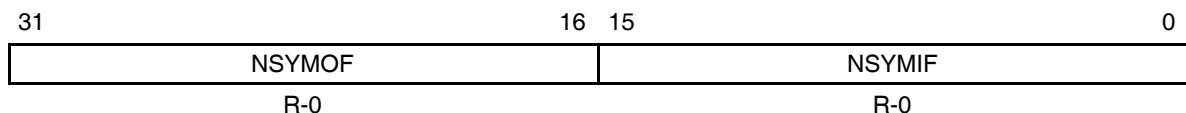

Legend: R = Read only; -n = value after reset

Table B–304. VCP Status Register 1 (VCPSTAT1) Field Values

Bit	field [†]	symval [†]	Value	Description
31–16	NSYMOF	OF(value)	0–FFFFh	Number of symbols in the output FIFO buffer.
15–0	NSYMIF	OF(value)	0–FFFFh	Number of symbols in the input FIFO buffer.

[†] For CSL implementation, use the notation VCP_STAT1_field_symval

B.20.13 VCP Error Register (VCPERR)

The VCP error register (VCPERR) is shown in Figure B–291 and described in Table B–305.

Figure B–291. VCP Error Register (VCPERR)

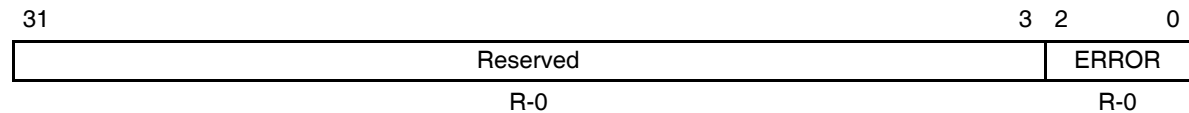

Legend: R = Read only; R/W = Read/Write; -n = value after reset

Table B–305. VCP Error Register (VCPERR) Field Values

Bit	Field	<i>symval</i> [†]	Value	Description
31–3	Reserved	–	0	Reserved. The reserved bit location is always read as 0. A value written to this field has no effect.
2–0	ERROR		0–7h	VCP error indicator bits.
		NO	0	No error is detected.
		TBNA	1h	Traceback mode is not allowed.
		FTL	2h	F too large for tailed traceback mode.
		FCTL	3h	<i>R + C</i> too large for mixed or convergent traceback modes.
		–	4h–7h	Reserved

[†] For CSL implementation, use the notation `VCP_ERR_ERROR_symval`

B.21 VIC Port Registers

The VIC port registers are listed in Table B–306. See the device-specific datasheet for the memory address of these registers.

Table B–306. VIC Port Registers

Offset Address [†]	Acronym	Register Name	Section
00h	VICCTL	VIC Control Register	B.21.1
04h	VICIN	VIC Input Register	B.21.2
08h	VICDIV	VIC Clock Divider Register	B.21.3

[†] The absolute address of the registers is device specific and is equal to the base address + offset address. See the device-specific datasheet to verify the register addresses.

B.21.1 VIC Control Register (VICCTL)

The VIC control register (VICCTL) is shown in Figure B–292 and described in Table B–307.

Figure B–292. VIC Control Register (VICCTL)

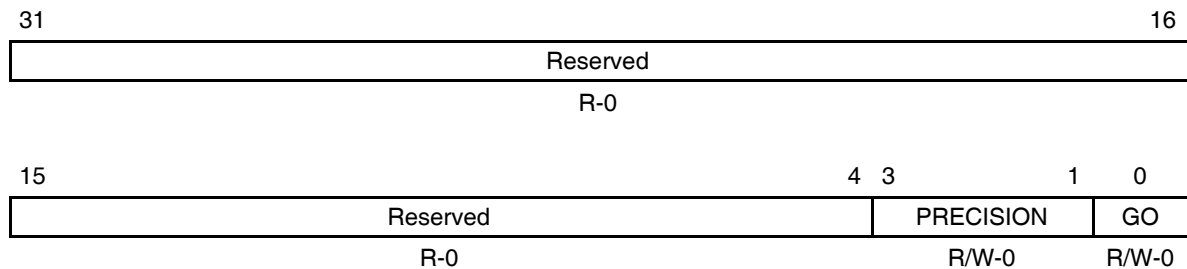

Legend: R = Read only; R/W = Read/Write; -n = value after reset

Table B–307. VIC Control Register (VICCTL) Field Values

Bit	field [†]	symval [†]	Value	Description
31–4	Reserved	–	0	Reserved. The reserved bit location is always read as 0. A value written to this field has no effect.
3–1	PRECISION		0–7h	Precision bits determine the resolution of the interpolation. The PRECISION bits can only be written when the GO bit is cleared to 0. If the GO bit is set to 1, a write to the PRECISION bits does not change the bits.
		16BITS	0	16 bits
		15BITS	1	15 bits
		14BITS	2h	14 bits
		13BITS	3h	13 bits
		12BITS	4h	12 bits
		11BITS	5h	11 bits
		10BITS	6h	10 bits
		9BITS	7h	9 bits
0	GO			The GO bit can be written to at any time.
		0	0	The VICDIV and VICCTL registers can be written to without affecting the operation of the VIC port. All the logic in the VIC port is held in reset state and a 0 is output on the VCTL output line. A write to VICCTL bits as well as setting GO to 1 is allowed in a single write operation. The VICCTL bits change and the GO bit is set, disallowing any further changes to the VICCTL and VICDIV registers.
		1	1	The VICDIV and VICCTL (except for the GO bit) registers cannot be written. If a write is performed to the VICDIV or VICCTL registers when the GO bit is set, the values of these registers remain unchanged. If a write is performed that clears the GO bit to 0 and changes the values of other VICCTL bits, it results in GO = 0 while keeping the rest of the VICCTL bits unchanged. The VIC port is in its normal working mode in this state.

[†] For CSL implementation, use the notation VIC_VICCTL_field_symval

B.21.2 VIC Input Register (VICIN)

The DSP writes the input bits for VCXO interpolated control in the VIC input register (VICIN). The DSP decides how often to update VICIN. The DSP can write to VICIN only when the GO bit in the VIC control register (VICCTL) is set to 1. The VIC module uses the MSBs of VICIN for precision values less than 16. The VICIN is shown in Figure B–293 and described in Table B–308.

Figure B–293. VIC Input Register (VICIN)

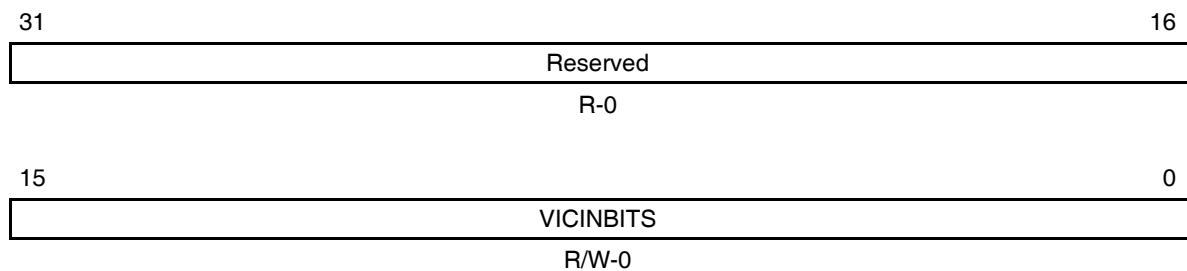

Legend: R = Read only; R/W = Read/Write; -n = value after reset

Table B–308. VIC Input Register (VICIN) Field Values

Bit	Field	symval [†]	Value	Description
31–16	Reserved	–	0	Reserved. The reserved bit location is always read as 0. A value written to this field has no effect.
15–0	VICINBITS	OF(value)	0–FFFFh	The DSP writes the input bits for VCXO interpolated control to the VIC input bits.

[†] For CSL implementation, use the notation VIC_VICIN_VICINBITS_symval

B.21.3 VIC Clock Divider Register (VICDIV)

The VIC clock divider register (VICDIV) defines the clock divider for the VIC interpolation frequency. The VIC interpolation frequency is obtained by dividing the module clock. The divider value written to VICDIV is:

$$\text{Divider} = \text{Rond}[DCLK/R]$$

where *DCLK* is the CPU clock divided by 2, and *R* is the desired interpolation frequency. The interpolation frequency depends on precision β .

The default value of VICDIV is 0001h; 0000h is an illegal value. The VIC module uses a value of 0001h whenever 0000h is written to this register.

The DSP can write to VICDIV only when the GO bit in VICCTL is cleared to 0. If a write is performed when the GO bit is set to 1, the VICDIV bits remain unchanged. The VICDIV is shown in Figure B–294 and described in Table B–309.

Figure B–294. VIC Clock Divider Register (VICDIV)

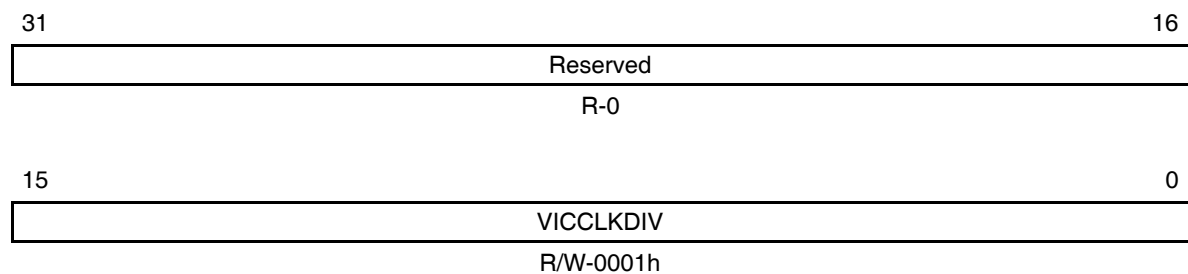

Legend: R = Read only; R/W = Read/Write; -n = value after reset

Table B–309. VIC Clock Divider Register (VICDIV) Field Values

Bit	Field	symval [†]	Value	Description
31–16	Reserved	–	0	Reserved. The reserved bit location is always read as 0. A value written to this field has no effect.
15–0	VICCLKDIV	OF(<i>value</i>)	0–FFFFh	The VIC clock divider bits define the clock divider for the VIC interpolation frequency.
		DEFAULT	1	

[†] For CSL implementation, use the notation VIC_VICDIV_VICCLKDIV_symval

B.22 Video Port Control Registers

The video port control registers are listed in Table B–310. See the device-specific datasheet for the memory address of these registers.

After enabling the video port in the peripheral configuration register (PERCFG), there should be a delay of 64 CPU cycles before accessing the video port registers.

Table B–310. Video Port Control Registers

Offset Address [†]	Acronym	Register Name	Section
C0h	VPCTL	Video Port Control Register	B.22.1
C4h	VPSTAT	Video Port Status Register	B.22.2
C8h	VPIE	Video Port Interrupt Enable Register	B.22.3
CCh	VPIS	Video Port Interrupt Status Register	B.22.4

[†] The absolute address of the registers is device/port specific and is equal to the base address + offset address. See the device-specific datasheet to verify the register addresses.

B.22.1 Video Port Control Register (VPCTL)

The video port control register (VPCTL) determines the basic operation of the video port. The VPCTL is shown in Figure B–295 and described in Table B–311.

Not all combinations of the port control bits are unique. The control bit encoding is shown in Table B–312. Additional mode options are selected using the video capture channel A control register (VCACTL) and video display control register (VDCTL).

Figure B–295. Video Port Control Register (VPCTL)

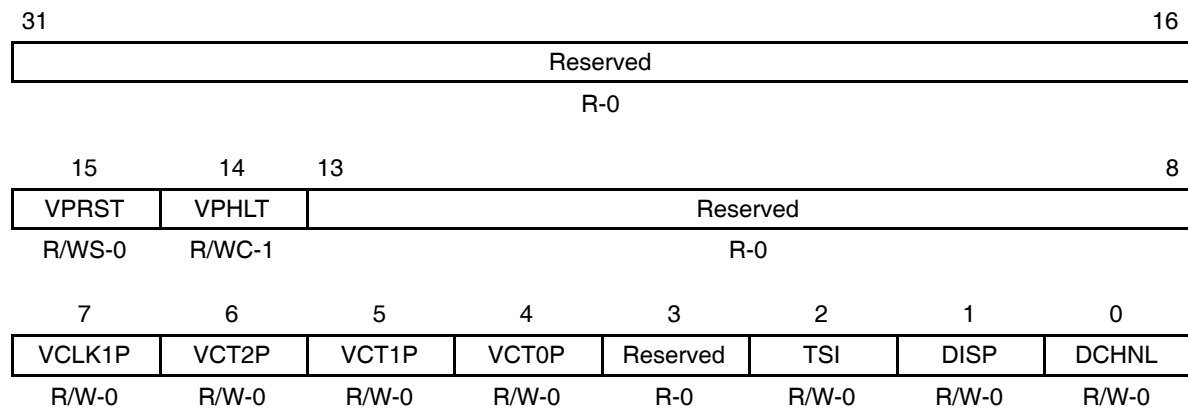

Legend: R = Read only; R/W = Read/Write; WC = Write a 1 to clear; WS = Write 1 to set, write of 0 has no effect; -n = value after reset

Table B–311. Video Port Control Register (VPCTL) Field Values

Bit	field†	symval†	Value	Description
31–16	Reserved	–	0	Reserved. The reserved bit location is always read as 0. A value written to this field has no effect.
15	VPRST	NO	0	Video port software reset enable bit. VPRST is set by writing a 1. Writing 0 has no effect.
		RESET	1	Flush all FIFOs and set all port registers to their initial values. VCLK0 and VCLK1 are configured as inputs and all VDATA and VCTL pins are placed in high impedance. Auto-cleared after reset is complete.

† For CSL implementation, use the notation VP_VPCTL_field_symval

Table B–311. Video Port Control Register (VPCTL) Field Values (Continued)

Bit	field [†]	symval [†]	Value	Description
14	VPHLT			Video port halt bit. This bit is set upon hardware or software reset. The other VPCTL bits (except VPRST) can only be changed when VPHLT is 1. VPHLT is cleared by writing a 1. Writing 0 has no effect.
		NONE	0	
		CLEAR	1	
13–6	Reserved	–	0	Reserved. The reserved bit location is always read as 0. A value written to this field has no effect.
7	VCLK1P			VCLK1 pin polarity bit. Has no effect in capture mode.
		NONE	0	
		REVERSE	1	Inverts the VCLK1 output clock polarity in display mode.
6	VCTL2P			VCTL2 pin polarity. Does not affect GPIO operation. If VCTL2 pin is used as a FLD input on the video capture side, then the VCTL2 polarity is not considered; the field inverse is controlled by the FINV bit in the video capture channel x control register (VCxCTL).
		NONE	0	
		ACTIVELOW	1	Indicates the VCTL2 control signal (input or output) is active low.
5	VCTL1P			VCTL1 pin polarity bit. Does not affect GPIO operation.
		NONE	0	
		ACTIVELOW	1	Indicates the VCTL1 control signal (input or output) is active low.
4	VCTL0P			VCTL0 pin polarity bit. Does not affect GPIO operation.
		NONE	0	
		ACTIVELOW	1	Indicates the VCTL0 control signal (input or output) is active low.
3	Reserved	–	0	Reserved. The reserved bit location is always read as 0. A value written to this field has no effect.

[†] For CSL implementation, use the notation `VP_VPCTL_field_symval`

Table B–311. Video Port Control Register (VPCTL) Field Values (Continued)

Bit	field [†]	symval [†]	Value	Description
2	TSI			TSI capture mode select bit.
		NONE	0	TSI capture mode is disabled.
		CAPTURE	1	TSI capture mode is enabled.
1	DISP			Display mode select bit. VDATA pins are configured for output. VCLK1 pin is configured as VCLKOUT output.
		CAPTURE	0	Capture mode is enabled.
		DISPLAY	1	Display mode is enabled.
0	DCHNL			Dual channel operation select bit. If the DCDIS bit in VPSTAT is set, this bit is forced to 0.
		SINGLE	0	Single-channel operation is enabled.
		DUAL	1	Dual-channel operation is enabled.

[†] For CSL implementation, use the notation VP_VPCTL_field_symval

Table B–312. Video Port Operating Mode Selection

VPCTL Bit			Operating Mode
TSI	DISP	DCHNL	
0	0	0	Single channel video capture. BT.656, Y/C or raw mode as selected in VCACTL. Video capture B channel not used.
0	0	1	Dual channel video capture. Either BT.656 or raw 8/10-bit as selected in VCACTL and VCBCTL. Option is available only if DCDIS is 0.
0	1	x	Single channel video display. BT.656, Y/C or raw mode as selected in VDCTL. Video display B channel is only used for dual channel sync raw mode.
1	x	x	Single channel TSI capture.

B.22.2 Video Port Status Register (VPSTAT)

The video port status register (VPSTAT) indicates the current condition of the video port. The VPSTAT is shown in Figure B–296 and described in Table B–313.

Figure B–296. Video Port Status Register (VPSTAT)

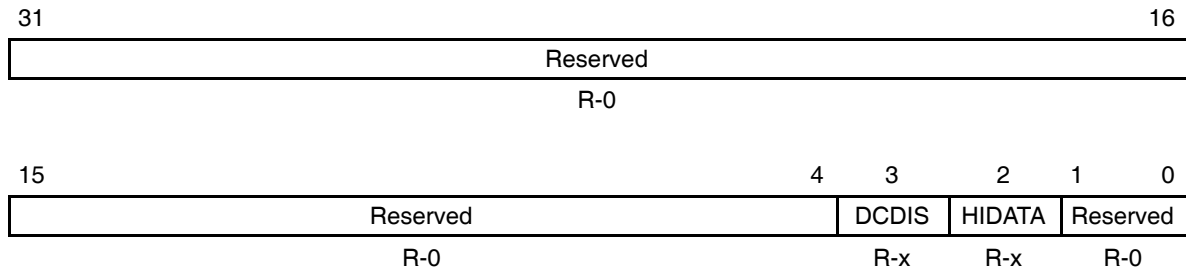

Legend: R = Read only; -n = value after reset; -x = value is determined by chip-level configuration

Table B–313. Video Port Status Register (VPSTAT) Field Values

Bit	field [†]	symval [†]	Value	Description
31–4	Reserved	–	0	Reserved. The reserved bit location is always read as 0. A value written to this field has no effect.
3	DCDIS			Dual-channel disable bit. The default value is determined by the chip-level configuration.
		ENABLE	0	Dual-channel operation is enabled.
		DISABLE	1	Port muxing selections prevent dual-channel operation.
2	HIDATA			High data bus half. HIDATA does not affect video port operation but is provided to inform you which VDATA pins may be controlled by the video port GPIO registers. HIDATA is never set unless DCDIS is also set. The default value is determined by the chip-level configuration.
		NONE	0	
		USE	1	Indicates that another peripheral is using VDATA[9–0] and the video port channel A (VDIN[9–0] or VDOOUT[9–0]) is muxed onto VDATA[19–10].
1–0	Reserved	–	0	Reserved. The reserved bit location is always read as 0. A value written to this field has no effect.

[†] For CSL implementation, use the notation VP_VPSTAT_field_symval

B.22.3 Video Port Interrupt Enable Register (VPIE)

The video port interrupt enable register (VPIE) enables sources of the video port interrupt to the DSP. The VPIE is shown in Figure B–297 and described in Table B–314.

Figure B–297. Video Port Interrupt Enable Register (VPIE)

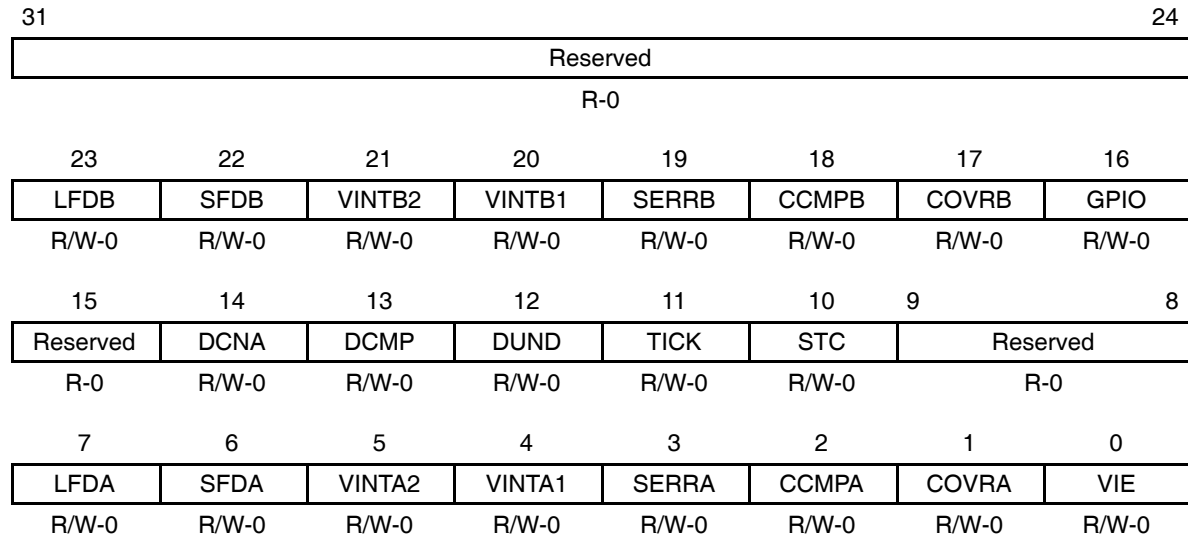

Legend: R = Read only; R/W = Read/Write; -n = value after reset

Table B–314. Video Port Interrupt Enable Register (VPIE) Field Values

Bit	field†	symval†	Value	Description
31–24	Reserved	–	0	Reserved. The reserved bit location is always read as 0. A value written to this field has no effect.
23	LFDB			Long field detected on channel B interrupt enable bit.
		DISABLE	0	Interrupt is disabled.
		ENABLE	1	Interrupt is enabled.
22	SFDB			Short field detected on channel B interrupt enable bit.
		DISABLE	0	Interrupt is disabled.
		ENABLE	1	Interrupt is enabled.
21	VINTB2			Channel B field 2 vertical interrupt enable bit.
		DISABLE	0	Interrupt is disabled.
		ENABLE	1	Interrupt is enabled.

† For CSL implementation, use the notation VP_VPIE_field_symval

Table B–314. Video Port Interrupt Enable Register (VPIE) Field Values (Continued)

Bit	field [†]	symval [†]	Value	Description
20	VINTB1			Channel B field 1 vertical interrupt enable bit.
		DISABLE	0	Interrupt is disabled.
		ENABLE	1	Interrupt is enabled.
19	SERRB			Channel B synchronization error interrupt enable bit.
		DISABLE	0	Interrupt is disabled.
		ENABLE	1	Interrupt is enabled.
18	CCMPB			Capture complete on channel B interrupt enable bit.
		DISABLE	0	Interrupt is disabled.
		ENABLE	1	Interrupt is enabled.
17	COVRB			Capture overrun on channel B interrupt enable bit.
		DISABLE	0	Interrupt is disabled.
		ENABLE	1	Interrupt is enabled.
16	GPIO			Video port general purpose I/O interrupt enable bit.
		DISABLE	0	Interrupt is disabled.
		ENABLE	1	Interrupt is enabled.
15	Reserved	–	0	Reserved. The reserved bit location is always read as 0. A value written to this field has no effect.
14	DCNA			Display complete not acknowledged bit.
		DISABLE	0	Interrupt is disabled.
		ENABLE	1	Interrupt is enabled.
13	DCMP			Display complete interrupt enable bit.
		DISABLE	0	Interrupt is disabled.
		ENABLE	1	Interrupt is enabled.
12	DUND			Display underrun interrupt enable bit.
		DISABLE	0	Interrupt is disabled.
		ENABLE	1	Interrupt is enabled.
11	TICK			System time clock tick interrupt enable bit.
		DISABLE	0	Interrupt is disabled.
		ENABLE	1	Interrupt is enabled.

[†] For CSL implementation, use the notation `VP_VPIE_field_symval`

Table B–314. Video Port Interrupt Enable Register (VPIE) Field Values (Continued)

Bit	field [†]	symval [†]	Value	Description
10	STC			System time clock interrupt enable bit.
		DISABLE	0	Interrupt is disabled.
		ENABLE	1	Interrupt is enabled.
9–8	Reserved	–	0	Reserved. The reserved bit location is always read as 0. A value written to this field has no effect.
7	LFDA			Long field detected on channel A interrupt enable bit.
		DISABLE	0	Interrupt is disabled.
		ENABLE	1	Interrupt is enabled.
6	SFDA			Short field detected on channel A interrupt enable bit.
		DISABLE	0	Interrupt is disabled.
		ENABLE	1	Interrupt is enabled.
5	VINTA2			Channel A field 2 vertical interrupt enable bit.
		DISABLE	0	Interrupt is disabled.
		ENABLE	1	Interrupt is enabled.
4	VINTA1			Channel A field 1 vertical interrupt enable bit.
		DISABLE	0	Interrupt is disabled.
		ENABLE	1	Interrupt is enabled.
3	SERRA			Channel A synchronization error interrupt enable bit.
		DISABLE	0	Interrupt is disabled.
		ENABLE	1	Interrupt is enabled.
2	CCMPA			Capture complete on channel A interrupt enable bit.
		DISABLE	0	Interrupt is disabled.
		ENABLE	1	Interrupt is enabled.
1	COVRA			Capture overrun on channel A interrupt enable bit.
		DISABLE	0	Interrupt is disabled.
		ENABLE	1	Interrupt is enabled.
0	VIE			Video port global interrupt enable bit. Must be set for interrupt to be sent to DSP.
		DISABLE	0	Interrupt is disabled.
		ENABLE	1	Interrupt is enabled.

[†] For CSL implementation, use the notation VP_VPIE_field_symval

B.22.4 Video Port Interrupt Status Register (VPIS)

The video port interrupt status register (VPIS) displays the status of video port interrupts to the DSP. The interrupt is only sent to the DSP if the corresponding enable bit in VPIS is set. All VPIS bits are cleared by writing a 1, writing a 0 has no effect. The VPIS is shown in Figure B–298 and described in Table B–315.

Figure B–298. Video Port Interrupt Status Register (VPIS)

Reserved							
R-0							
23	22	21	20	19	18	17	16
LFDB	SFDB	VINTB2	VINTB1	SERRB	CCMPB	COVRB	GPIO
R/WC-0	R/WC-0	R/WC-0	R/WC-0	R/WC-0	R/WC-0	R/WC-0	R/WC-0
15	14	13	12	11	10	9	8
Reserved	DCNA	DCMP	DUND	TICK	STC	Reserved	
R-0	R/WC-0	R/WC-0	R/WC-0	R/WC-0	R/WC-0	R-0	
7	6	5	4	3	2	1	0
LFDA	SFDA	VINTA2	VINTA1	SERRA	CCMPA	COVRA	Reserved
R/WC-0	R/WC-0	R/WC-0	R/WC-0	R/WC-0	R/WC-0	R/WC-0	R-0

Legend: R = Read only; WC = Write 1 to clear, write of 0 has no effect; -n = value after reset

Table B–315. Video Port Interrupt Status Register (VPIS) Field Values

Bit	field	symval	Value	Description
31–24	Reserved	–	0	Reserved. The reserved bit location is always read as 0. A value written to this field has no effect.
23	LFDB			Long field detected on channel B interrupt detected bit. (A long field is only detected when the VRST bit in VCBCTL is cleared to 0; when VRST = 1, a long field is always detected.) BT.656 or Y/C capture mode – LFDB is set when long field detection is enabled and VCOUNT is not reset before VCOUNT = YSTOP + 1. Raw data mode, or TSI capture mode or display mode – Not used.
		NONE	0	No interrupt is detected.
		CLEAR	1	Interrupt is detected. Bit is cleared.

† For CSL implementation, use the notation VP_VPIS_field_symval

Table B–315. Video Port Interrupt Status Register (VPIS) Field Values (Continued)

Bit	field	symval	Value	Description
22	SFDB			Short field detected on channel B interrupt detected bit. BT.656 or Y/C capture mode – SFDB is set when short field detection is enabled and VCOUNT is reset before VCOUNT = YSTOP. Raw data mode, or TSI capture mode or display mode – Not used.
		NONE	0	No interrupt is detected.
		CLEAR	1	Interrupt is detected. Bit is cleared.
21	VINTB2			Channel B field 2 vertical interrupt detected bit. BT.656 or Y/C capture mode – VINTB2 is set when a vertical interrupt occurred in field 2. Raw data mode or TSI capture mode – Not used.
		NONE	0	No interrupt is detected.
		CLEAR	1	Interrupt is detected. Bit is cleared.
20	VINTB1			Channel B field 1 vertical interrupt detected bit. BT.656 or Y/C capture mode – VINTB1 is set when a vertical interrupt occurred in field 1. Raw data mode or TSI capture mode – Not used.
		NONE	0	No interrupt is detected.
		CLEAR	1	Interrupt is detected. Bit is cleared.
19	SERRB			Channel B synchronization error interrupt detected bit. BT.656 or Y/C capture mode – Synchronization parity error on channel B. An SERRB typically requires resetting the channel (RSTCH) or the port (VPRST). Raw data mode or TSI capture mode – Not used.
		NONE	0	No interrupt is detected.
		CLEAR	1	Interrupt is detected. Bit is cleared.

† For CSL implementation, use the notation VP_VPIS_field_symval

Table B–315. Video Port Interrupt Status Register (VPIS) Field Values (Continued)

Bit	field	symval	Value	Description
18	CCMPB			Capture complete on channel B interrupt detected bit. (Data is not in memory until the DMA transfer is complete.) BT.656 or Y/C capture mode – CCMPB is set after capturing an entire field or frame (when F1C, F2C, or FRMC in VCBSTAT are set) depending on the CON, FRAME, CF1, and CF2 control bits in VCBCTL. Raw data mode – RDFE is not set, CCMPB is set when FRMC in VCBSTAT is set (when the data counter = the combined VCYSTOP/VCXSTOP value). TSI capture mode – CCMPB is set when FRMC in VCBSTAT is set (when the data counter = the combined VCYSTOP/VCXSTOP value).
		NONE	0	No interrupt is detected.
		CLEAR	1	Interrupt is detected. Bit is cleared.
17	COVRB			Capture overrun on channel B interrupt detected bit. COVRB is set when data in the FIFO was overwritten before being read out (by the DMA).
		NONE	0	No interrupt is detected.
		CLEAR	1	Interrupt is detected. Bit is cleared.
16	GPIO			Video port general purpose I/O interrupt detected bit.
		NONE	0	No interrupt is detected.
		CLEAR	1	Interrupt is detected. Bit is cleared.
15	Reserved	–	0	Reserved. The reserved bit location is always read as 0. A value written to this field has no effect.
14	DCNA			Display complete not acknowledged. Indicates that the F1D, F2D, or FRMD bit that caused the display complete interrupt was not cleared prior to the start of the next gating field or frame.
		NONE	0	No interrupt is detected.
		CLEAR	1	Interrupt is detected. Bit is cleared.

† For CSL implementation, use the notation `VP_VPIS_field_symval`

Table B–315. Video Port Interrupt Status Register (VPIS) Field Values (Continued)

Bit	field	symval	Value	Description
13	DCMP			Display complete. Indicates that the entire frame has been driven out of the port. The DMA complete interrupt can be used to determine when the last data has been transferred from memory to the FIFO. DCMP is set after displaying an entire field or frame (when F1D, F2D or FRMD in VDSTAT are set) depending on the CON, FRAME, DF1, and DF2 control bits in VDCTL.
		NONE	0	No interrupt is detected.
		CLEAR	1	Interrupt is detected. Bit is cleared.
12	DUND	NONE	0	Display underrun. Indicates that the display FIFO ran out of data. No interrupt is detected.
		CLEAR	1	Interrupt is detected. Bit is cleared.
11	TICK			System time clock tick interrupt detected bit. BT.656, Y/C capture mode or raw data mode – Not used. TSI capture mode –TICK is set when the TCKEN bit in TSICTL is set and the desired number of system time clock ticks has occurred as programmed in TSITICKS.
		NONE	0	No interrupt is detected.
		CLEAR	1	Interrupt is detected. Bit is cleared.
10	STC			System time clock interrupt detected bit. BT.656, Y/C capture mode or raw data mode – Not used. TSI capture mode – STC is set when the system time clock reaches an absolute time as programmed in TSISTCmpl and TSISTCMPM registers and the STEN bit in TSICTL is set.
		NONE	0	No interrupt is detected.
		CLEAR	1	Interrupt is detected. Bit is cleared.
9–8	Reserved	–	0	Reserved. The reserved bit location is always read as 0. A value written to this field has no effect.

† For CSL implementation, use the notation VP_VPIS_field_symval

Table B–315. Video Port Interrupt Status Register (VPIS) Field Values (Continued)

Bit	field	symval	Value	Description
7	LFDA			Long field detected on channel A interrupt detected bit. (A long field is only detected when the VRST bit in VCACTL is cleared to 0; when VRST = 1, a long field is always detected.) BT.656 or Y/C capture mode – LFDA is set when long field detection is enabled and VCOUNT is not reset before VCOUNT = YSTOP + 1. Raw data mode, or TSI capture mode or display mode – Not used.
		NONE	0	No interrupt is detected.
		CLEAR	1	Interrupt is detected. Bit is cleared.
6	SFDA			Short field detected on channel A interrupt detected bit. BT.656 or Y/C capture mode – SFDA is set when short field detection is enabled and VCOUNT is reset before VCOUNT = YSTOP. Raw data mode, or TSI capture mode or display mode – Not used.
		NONE	0	No interrupt is detected.
		CLEAR	1	Interrupt is detected. Bit is cleared.
5	VINTA2			Channel A field 2 vertical interrupt detected bit. BT.656, or Y/C capture mode or any display mode – VINTA2 is set when a vertical interrupt occurred in field 2. Raw data mode or TSI capture mode – Not used.
		NONE	0	No interrupt is detected.
		CLEAR	1	Interrupt is detected. Bit is cleared.
4	VINTA1			Channel A field 1 vertical interrupt detected bit. BT.656, or Y/C capture mode or any display mode – VINTA1 is set when a vertical interrupt occurred in field 1. Raw data mode or TSI capture mode – Not used.
		NONE	0	No interrupt is detected.
		CLEAR	1	Interrupt is detected. Bit is cleared.

† For CSL implementation, use the notation VP_VPIS_field_symval

Table B–315. Video Port Interrupt Status Register (VPIS) Field Values (Continued)

Bit	field	symval	Value	Description
3	SERRA			Channel A synchronization error interrupt detected bit. BT.656 or Y/C capture mode – Synchronization parity error on channel A. An SERRA typically requires resetting the channel (RSTCH) or the port (VPRST). Raw data mode or TSI capture mode – Not used.
		NONE	0	No interrupt is detected.
		CLEAR	1	Interrupt is detected. Bit is cleared.
2	CCMPA			Capture complete on channel A interrupt detected bit. (Data is not in memory until the DMA transfer is complete.) BT.656 or Y/C capture mode – CCMPA is set after capturing an entire field or frame (when F1C, F2C, or FRMC in VCASTAT are set) depending on the CON, FRAME, CF1, and CF2 control bits in VCACTL. Raw data mode – If RDFE bit is set, CCMPA is set when F1C, F2C, or FRMC in VCASTAT is set (when the data counter = the combined VCYSTOP/VCXSTOP value) depending on the CON, FRAME, CF1, and CF2 control bits in VCACTL. If RDFE bit is not set, CCMPA is set when FRMC in VCASTAT is set (when the data counter = the combined VCYSTOP/VCXSTOP value). TSI capture mode – CCMPA is set when FRMC in VCASTAT is set (when the data counter = the combined VCYSTOP/VCXSTOP value).
		NONE	0	No interrupt is detected.
		CLEAR	1	Interrupt is detected. Bit is cleared.
1	COVRA			Capture overrun on channel A interrupt detected bit. COVRA is set when data in the FIFO was overwritten before being read out (by the DMA).
		NONE	0	No interrupt is detected.
		CLEAR	1	Interrupt is detected. Bit is cleared.
0	Reserved	–	0	Reserved. The reserved bit location is always read as 0. A value written to this field has no effect.

† For CSL implementation, use the notation VP_VPIS_field_symval

B.23 Video Capture Registers

The registers for controlling the video capture mode of operation are listed in Table B–316. See the device-specific datasheet for the memory address of these registers.

Table B–316. Video Capture Control Registers

Offset Address [†]	Acronym	Register Name	Section
100h	VCASTAT	Video Capture Channel A Status Register	B.23.1
104h	VCACTL	Video Capture Channel A Control Register	B.23.2
108h	VCASTRT1	Video Capture Channel A Field 1 Start Register	B.23.3
10Ch	VCASTOP1	Video Capture Channel A Field 1 Stop Register	B.23.4
110h	VCASTRT2	Video Capture Channel A Field 2 Start Register	B.23.5
114h	VCASTOP2	Video Capture Channel A Field 2 Stop Register	B.23.6
118h	VCAVINT	Video Capture Channel A Vertical Interrupt Register	B.23.7
11Ch	VCATHRLD	Video Capture Channel A Threshold Register	B.23.8
120h	VCAEVTCT	Video Capture Channel A Event Count Register	B.23.9
140h	VCBSTAT	Video Capture Channel B Status Register	B.23.1
144h	VCBCTL	Video Capture Channel B Control Register	B.23.10
148h	VCBSTRT1	Video Capture Channel B Field 1 Start Register	B.23.3
14Ch	VCBSTOP1	Video Capture Channel B Field 1 Stop Register	B.23.4
150h	VCBSTRT2	Video Capture Channel B Field 2 Start Register	B.23.5
154h	VCBSTOP2	Video Capture Channel B Field 2 Stop Register	B.23.6
158h	VCBVINT	Video Capture Channel B Vertical Interrupt Register	B.23.7
15Ch	VCBTHRLD	Video Capture Channel B Threshold Register	B.23.8
160h	VCBEVTCT	Video Capture Channel B Event Count Register	B.23.9
180h	TSICTL	TSI Capture Control Register	B.23.11
184h	TSICKINITL	TSI Clock Initialization LSB Register	B.23.12
188h	TSICKINITM	TSI Clock Initialization MSB Register	B.23.13

[†] The absolute address of the registers is device/port specific and is equal to the base address + offset address. See the device-specific datasheet to verify the register addresses.

Table B–316. Video Capture Control Registers (Continued)

Offset Address [†]	Acronym	Register Name	Section
18Ch	TSISTCLKL	TSI System Time Clock LSB Register	B.23.14
190h	TSISTCLKM	TSI System Time Clock MSB Register	B.23.15
194h	TSISTCMPL	TSI System Time Clock Compare LSB Register	B.23.16
198h	TSISTCMPM	TSI System Time Clock Compare MSB Register	B.23.17
19Ch	TSISTMSKL	TSI System Time Clock Compare Mask LSB Register	B.23.18
1A0h	TSISTMSKM	TSI System Time Clock Compare Mask MSB Register	B.23.19
1A4h	TSITICKS	TSI System Time Clock Ticks Interrupt Register	B.23.20

[†] The absolute address of the registers is device/port specific and is equal to the base address + offset address. See the device-specific datasheet to verify the register addresses.

B.23.1 Video Capture Channel x Status Register (VCASTAT, VCBSTAT)

The video capture channel x status register (VCASTAT, VCBSTAT) indicates the current status of the video capture channel. The VCxSTAT is shown in Figure B–299 and described in Table B–317.

In BT.656 capture mode, the VCXPOS and VCYPOS bits indicate the HCOUNT and VCOUNT values, respectively, to track the coordinates of the most recently received pixel. The F1C, F2C, and FRMC bits indicate completion of fields or frames and may need to be cleared by the DSP for capture to continue, depending on the selected frame capture operation.

In raw data and TSI modes, the VCXPOS and VCYPOS bits reflect the lower and upper 12 bits, respectively, of the 24-bit data counter that tracks the number of received data samples. The FRMC bit indicates when an entire data packet has been received and may need to be cleared by the DSP for capture to continue, depending on the selected frame operation.

Figure B–299. Video Capture Channel *x* Status Register (VCASTAT, VCBSTAT)

31	30	29	28	27	16
FSYNC	FRMC	F2C	F1C	VCYPOS	
R-0	R/WC-0	R/WC-0	R/WC-0	R-0	
		13	12	11	0
Reserved			VCFLD	VCXPOS	
R-0			R-0	R-0	

Legend: R = Read only; WC = Write 1 to clear, write of 0 has no effect; -*n* = value after reset

Table B–317. Video Capture Channel *x* Status Register (VCxSTAT)
Field Values

Bit	field [†]	symval [†]	Value	Description		
				BT.656 or Y/C Mode	Raw Data Mode	TSI Mode
31	FSYNC	CLEAR	0	VCOUNT = VINT1 or VINT2, as selected by the FSCL2 bit in VCxVINT.	Not used.	Not used.
		SET	1	VCOUNT = 1 in field 1.	Not used.	Not used.
30	FRMC	NONE	0	Complete frame has not been captured.	Complete data block has not been captured.	Entire data packet has not been captured.
		CAPTURED CLEAR	1	Complete frame has been captured.	Complete data block has been captured.	Entire data packet has been captured.
29	F2C	NONE	0	Field 2 has not been captured.	Not used.	Not used.
		CAPTURED CLEAR	1	Field 2 has been captured.	Not used.	Not used.

[†] For CSL implementation, use the notation VP_VCxSTAT_*field_symval*

**Table B–317. Video Capture Channel *x* Status Register (VCxSTAT)
Field Values (Continued)**

Bit	field [†]	symval [†]	Value	Description		
				BT.656 or Y/C Mode	Raw Data Mode	TSI Mode
28	F1C			Field 1 captured bit. Write 1 to clear the bit, a write of 0 has no effect.		
		NONE	0	Field 1 has not been captured.	Not used.	Not used.
		CAPTURED CLEAR	1	Field 1 has been captured.	Not used.	Not used.
27–16	VCYPOS	OF(<i>value</i>)	0–FFFh	Current VCOUNT value and the line that is currently being received (within the current field).	Upper 12 bits of the data counter.	Upper 12 bits of the data counter.
15–13	Reserved	–	0	Reserved. The reserved bit location is always read as 0. A value written to this field has no effect.		
12	VCFLD			VCFLD bit indicates which field is currently being captured. The VCFLD bit is updated based on the field detection logic selected by the FLDD bit in VCACTL.		
		NONE	0	Field 1 is active.	Not used.	Not used.
		DETECTED	1	Field 2 is active.	Not used.	Not used.
11–0	VCXPOS	OF(<i>value</i>)	0–FFFh	Current HCOUNT value. The pixel index of the last received pixel.	Lower 12 bits of the data counter.	Lower 12 bits of the data counter.

[†] For CSL implementation, use the notation VP_VCxSTAT_*field_symval*

B.23.2 Video Capture Channel A Control Register (VCACTL)

Video capture is controlled by the video capture channel A control register (VCACTL) shown in Figure B–300 and described in Table B–318.

Figure B–300. Video Capture Channel A Control Register (VCACTL)

31	30	29						24
RSTCH	BLKCAP	Reserved						
R/WS-0	R/W-1	R-0						
23	22		21	20	19	18	17	16
Reserved		RDFE	FINV	EXC	FLDD	VRST	HRST	
R-0		R/W-0	R/W-0	R/W-0	R/W-0	R/W-0	R/W-1	R/W-0
15	14	13		12	11	10	9	8
VCEN	PK10B		LFDE	SFDE	RESMPL	Reserved	SCALE	
R/W-0	R/W-0		R/W-0	R/W-0	R/W-0	R-0	R/W-0	
7	6	5	4	3	2	0		
CON	FRAME	CF2	CF1	Reserved	CMODE			
R/W-0	R/W-0	R/W-1	R/W-1	R-0	R/W-0			

Legend: R = Read only; R/W = Read/Write; WS = Write 1 to reset, write of 0 has no effect; -n = value after reset

Table B–318. Video Capture Channel A Control Register (VCACTL)
Field Values

Bit	field [†]	symval [†]	Value	Description		
				BT.656 or Y/C Mode	Raw Data Mode	TSI Mode
31	RSTCH			Reset channel bit. Write 1 to reset the bit, a write of 0 has no effect.		
		NONE	0	No effect.		
		RESET	1	Resets the channel by blocking further DMA event generation and flushing the FIFO upon completion of any pending DMAs. Also clears the VCEN bit. All channel registers are set to their initial values. RSTCH is autocleared after channel reset is complete.		

[†] For CSL implementation, use the notation VP_VCACTL_field_symval

[‡] For complete encoding of these bits, see *TMS320C64x DSP Video Port/VCXO Interpolated Control (VIC) Port Reference Guide* (SPRU629).

**Table B–318. Video Capture Channel A Control Register (VCACTL)
Field Values (Continued)**

Bit	field [†]	symval [†]	Value	Description		
				BT.656 or Y/C Mode	Raw Data Mode	TSI Mode
30	BLKCAP			Block capture events bit. BLKCAP functions as a capture FIFO reset without affecting the current programmable register values. The F1C, F2C, and FRMC status bits, in VCASTAT, are not updated. Field or frame complete interrupts and vertical interrupts are also not generated. Clearing BLKCAP does not enable DMA events during the field where the bit is cleared. Whenever BLKCAP is set and then cleared, the software needs to clear the field and frame status bits (F1C, F2C, and FRMC) as part of the BLKCAP clear operation.		
		CLEAR	0	Enables DMA events in the video frame that follows the video frame where the bit is cleared. (The capture logic must sync to the start of the next frame after BLKCAP is cleared.)		
		BLOCK	1	Blocks DMA events and flushes the capture channel FIFOs.		
29–22	Reserved	–	0	Reserved. The reserved bit location is always read as 0. A value written to this field has no effect.		
21	RDFE			Field identification enable bit. (Channel A only)		
		DISABLE	0	Not used.	Field identification is disabled.	Not used.
		ENABLE	1	Not used.	Field identification is enabled.	Not used.
20	FINV			Detected field invert bit.		
		FIELD1	0	Detected 0 is field 1.	Not used.	Not used.
		FIELD2	1	Detected 0 is field 2.	Not used.	Not used.
19	EXC			External control select bit. (Channel A only)		
		EAVSAV	0	Use EAV/SAV codes.	Not used.	Not used.
		EXTERN	1	Use external control signals.	Not used.	Not used.

[†] For CSL implementation, use the notation `VP_VCACTL_field_symval`

[‡] For complete encoding of these bits, see *TMS320C64x DSP Video Port/VCXO Interpolated Control (VIC) Port Reference Guide* (SPRU629).

**Table B–318. Video Capture Channel A Control Register (VCACTL)
Field Values (Continued)**

Bit	field [†]	symval [†]	Value	Description		
				BT.656 or Y/C Mode	Raw Data Mode	TSI Mode
18	FLDD			Field detect method bit. (Channel A only)		
		EAVFID	0	1 st line EAV or FID input.	Not used.	Not used.
		FDL	1	Field detect logic.	Not used.	Not used.
17	VRST			VCOUNT reset method bit.		
		V1EAV	0	Start of vertical blank (1 st V = 1 EAV or VCTL1 active edge)	Not used.	Not used.
		VOEAV	1	End of vertical blank (1 st V = 0 EAV or VCTL1 inactive edge)	Not used.	Not used.
16	HRST			HCOUNT reset method bit.		
		EAV	0	EAV or VCTL0 active edge.	Not used.	Not used.
		SAV	1	SAV or VCTL0 inactive edge.	Not used.	Not used.
15	VCEN			Video capture enable bit. Other bits in VCACTL (except RSTCH and BLKCAP bits) may only be changed when VCEN = 0.		
		DISABLE	0	Video capture is disabled.		
		ENABLE	1	Video capture is enabled.		
14–13	PK10B		0–3h	10-bit packing format select bit.		
		ZERO	0	Zero extend	Zero extend	Not used.
		SIGN	1h	Sign extend	Sign extend	Not used.
		DENSEPK	2h	Dense pack (zero extend)	Dense pack (zero extend)	Not used.
		–	3h	Reserved	Reserved	Not used.

[†] For CSL implementation, use the notation VP_VCACTL_field_symval

[‡] For complete encoding of these bits, see *TMS320C64x DSP Video Port/VCXO Interpolated Control (VIC) Port Reference Guide* (SPRU629).

**Table B–318. Video Capture Channel A Control Register (VCACTL)
Field Values (Continued)**

Bit	field [†]	symval [†]	Value	Description		
				BT.656 or Y/C Mode	Raw Data Mode	TSI Mode
12	LFDE			Long field detect enable bit.		
		DISABLE	0	Long field detect is disabled.	Not used.	Not used.
		ENABLE	1	Long field detect is enabled.	Not used.	Not used.
11	SFDE			Short field detect enable bit.		
		DISABLE	0	Short field detect is disabled.	Not used.	Not used.
		ENABLE	1	Short field detect is enabled.	Not used.	Not used.
10	RESMPL			Chroma resampling enable bit.		
		DISABLE	0	Chroma resampling is disabled.	Not used.	Not used.
		ENABLE	1	Chroma is horizontally resampled from 4:2:2 co-sited to 4:2:0 interspersed before saving to chroma buffers.	Not used.	Not used.
9	Reserved	–	0	Reserved. The reserved bit location is always read as 0. A value written to this field has no effect.		
8	SCALE			Scaling select bit.		
		NONE	0	No scaling	Not used.	Not used.
		HALF	1	½ scaling	Not used.	Not used.
7	CON [‡]			Continuous capture enable bit.		
		DISABLE	0	Continuous capture is disabled.		
		ENABLE	1	Continuous capture is enabled.		

[†] For CSL implementation, use the notation VP_VCACTL_field_symval

[‡] For complete encoding of these bits, see *TMS320C64x DSP Video Port/VCXO Interpolated Control (VIC) Port Reference Guide* (SPRU629).

**Table B–318. Video Capture Channel A Control Register (VCACTL)
Field Values (Continued)**

Bit	field [†]	symval [†]	Value	Description		
				BT.656 or Y/C Mode	Raw Data Mode	TSI Mode
6	FRAME [‡]	NONE	0	Do not capture frame.	Do not capture single data block.	Do not capture single packet.
		FRMCAP	1	Capture frame.	Capture single data block.	Capture single packet.
5	CF2 [‡]	NONE	0	Do not capture field 2.	Do not capture field 2.	Not used.
		FLDCAP	1	Capture field 2.	Capture field 2.	Not used.
4	CF1 [‡]	NONE	0	Do not capture field 1.	Do not capture field 1.	Not used.
		FLDCAP	1	Capture field 1.	Capture field 1.	Not used.
3	Reserved	–	0	Reserved. The reserved bit location is always read as 0. A value written to this field has no effect.		
2–0	CMODE		0–7h	Capture mode select bit.		
		BT656B	0	Enables 8-bit BT.656 mode.		Not used.
		BT656D	1h	Enables 10-bit BT.656 mode.		Not used.
		RAWB	2h	Enables 8-bit raw data mode.		8-bit TSI mode.
		RAWD	3h	Enables 10-bit raw data mode.		Not used.
		YCB	4h	Enables 16-bit Y/C mode.		Not used.
		YCD	5h	Enables 20-bit Y/C mode.		Not used.
		RAW16	6h	Enables 16-bit raw mode.		Not used.
RAW20	7h	Enables 20-bit raw mode.		Not used.		

[†] For CSL implementation, use the notation `VP_VCACTL_field_symval`

[‡] For complete encoding of these bits, see *TMS320C64x DSP Video Port/VCXO Interpolated Control (VIC) Port Reference Guide* (SPRU629).

B.23.3 Video Capture Channel x Field 1 Start Register (VCASTRT1, VCBSTRT1)

The captured image is a subset of the incoming image. The video capture channel x field 1 start register (VCASTRT1, VCBSTRT1) defines the start of the field 1 captured image. Note that the size is defined relative to incoming data (before scaling). VCxSTRT1 is shown in Figure B–301 and described in Table B–319.

In BT.656 or Y/C modes, the horizontal (pixel) counter is reset (to 0) by the horizontal event (as selected by the HRST bit in VCxCTL) and the vertical (line) counter is reset (to 1) by the vertical event (as selected by the VRST bit in VCxCTL). Field 1 capture starts when HCOUNT = VCXSTART, VCOUNT = VCYSTART, and field 1 capture is enabled.

In raw capture mode, the VCVBLNKP bits defines the minimum vertical blanking period. If CAPEN stays deasserted longer than VCVBLNKP clocks, then a vertical blanking interval is considered to have occurred. If the SSE bit is set when the capture first begins (the VCEN bit is set in VCxCTL), the capture does not start until two intervals are counted. This allows the video port to synchronize its capture to the top of a frame when first started.

In TSI capture mode, the capture starts when the CAPEN signal is asserted, the FRMC bit (in VCxSTAT) is cleared, and a SYNC byte is detected.

Figure B–301. Video Capture Channel x Field 1 Start Register (VCASTRT1, VCBSTRT1)

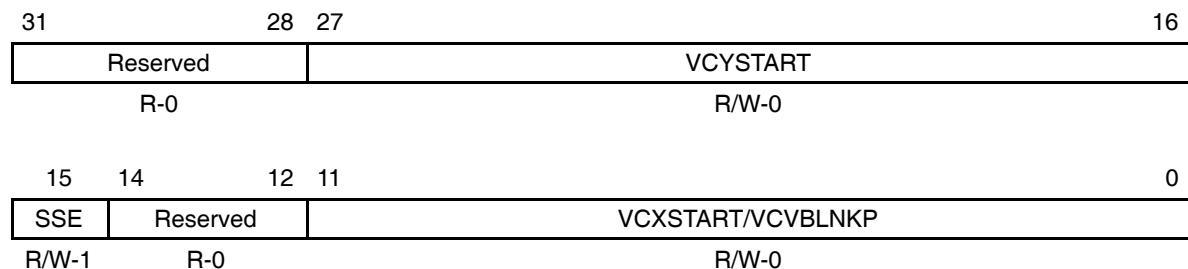

Legend: R = Read only; R/W = Read/Write; -n = value after reset

Table B–319. Video Capture Channel *x* Field 1 Start Register (VCxSTRT1) Field Values

Bit	field [†]	symval [†]	Value	Description		
				BT.656 or Y/C Mode	Raw Data Mode	TSI Mode
31–28	Reserved	–	0	Reserved. The reserved bit location is always read as 0. A value written to this field has no effect.		
27–16	VCYSTART	OF(<i>value</i>)	0–FFFh	Starting line number.	Not used.	Not used.
15	SSE			Startup synchronization enable bit.		
		DISABLE	0	Not used.	Startup synchronization is disabled.	Not used.
		ENABLE	1	Not used.	Startup synchronization is enabled.	Not used.
14–12	Reserved	–	0	Reserved. The reserved bit location is always read as 0. A value written to this field has no effect.		
11–0	VCXSTART VCVBLNKP	OF(<i>value</i>)	0–FFFh	VCXSTART bits define the starting pixel number. Must be an even number (LSB is treated as 0).	VCVBLNKP bits define the minimum CAPEN inactive time to be interpreted as a vertical blanking period.	Not used.

[†] For CSL implementation, use the notation VP_VCxSTRT1_*field_symval*

B.23.4 Video Capture Channel x Field 1 Stop Register (VCASTOP1, VCBSTOP1)

The video capture channel x field 1 stop register (VCASTOP1, VCBSTOP1) defines the end of the field 1-captured image or the end of the raw data or TSI packet. VCxSTOP1 is shown in Figure B–302 and described in Table B–320.

In raw capture mode, the horizontal and vertical counters are combined into a single counter that keeps track of the total number of samples received.

In TSI capture mode, the horizontal and vertical counters are combined into a single data counter that keeps track of the total number of bytes received. The capture starts when a SYNC byte is detected. The data counter counts bytes as they are received. The FRMC bit (in VCxSTAT) gets set each time a packet has been received.

Figure B–302. Video Capture Channel x Field 1 Stop Register (VCASTOP1, VCBSTOP1)

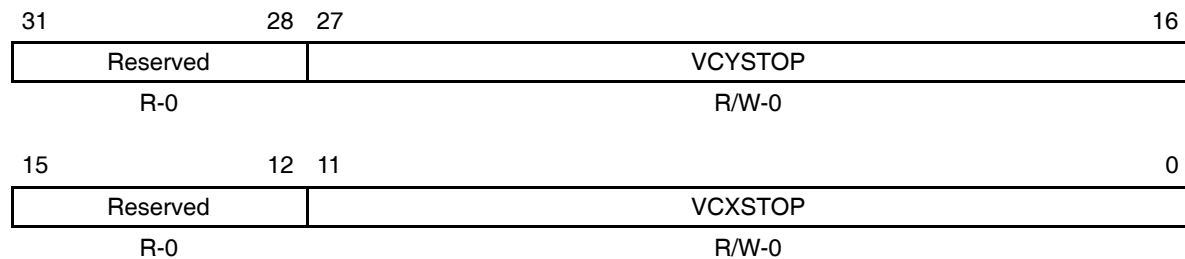

Legend: R = Read only; R/W = Read/Write; -n = value after reset

Table B–320. Video Capture Channel x Field 1 Stop Register (VCxSTOP1) Field Values

Bit	field†	symval†	Value	Description		
				BT.656 or Y/C Mode	Raw Data Mode	TSI Mode
31–28	Reserved	–	0	Reserved. The reserved bit location is always read as 0. A value written to this field has no effect.		
27–16	VCYSTOP	OF(value)	0–FFFh	Last captured line.	Upper 12 bits of the data size (in data samples).	Upper 12 bits of the data size (in data samples).
15–12	Reserved	–	0	Reserved. The reserved bit location is always read as 0. A value written to this field has no effect.		
11–0	VCXSTOP	OF(value)	0–FFFh	Last captured pixel (VCXSTOP – 1). Must be an even value (the LSB is treated as 0).	Lower 12 bits of the data size (in data samples).	Lower 12 bits of the data size (in data samples).

† For CSL implementation, use the notation VP_VCxSTOP1_field_symval

B.23.5 Video Capture Channel x Field 2 Start Register (VCASTR2, VCBSTR2)

The captured image is a subset of the incoming image. The video capture channel x field 2 start register (VCASTR2, VCBSTR2) defines the start of the field 2 captured image. (This allows different window alignment or size for each field.) Note that the size is defined relative to incoming data (before scaling). VCxSTR2 is shown in Figure B–303 and described in Table B–321.

In BT.656 or Y/C modes, the horizontal (pixel) counter is reset by the horizontal event (as selected by the HRST bit in VCxCTL) and the vertical (line) counter is reset by the vertical event (as selected by the VRST bit in VCxCTL). Field 2 capture starts when HCOUNT = VCXSTART, VCOUNT = VCYSTART, and field 2 capture is enabled.

These registers are not used in raw data mode or TSI mode because their capture sizes are completely defined by the field 1 start and stop registers.

Figure B–303. Video Capture Channel x Field 2 Start Register (VCASTR2, VCBSTR2)

31	28	27	16
Reserved		VCYSTART	
R-0		R/W-0	
15	12	11	0
Reserved		VCXSTART	
R-0		R/W-0	

Legend: R = Read only; R/W = Read/Write; -n = value after reset

Table B–321. Video Capture Channel x Field 2 Start Register (VCxSTR2) Field Values

Bit	field [†]	symval [†]	Value	Description		
				BT.656 or Y/C Mode	Raw Data Mode	TSI Mode
31–28	Reserved	–	0	Reserved. The reserved bit location is always read as 0. A value written to this field has no effect.		
27–16	VCYSTART	OF(value)	0–FFFh	Starting line number.	Not used.	Not used.
15–12	Reserved	–	0	Reserved. The reserved bit location is always read as 0. A value written to this field has no effect.		
11–0	VCXSTART	OF(value)	0–FFFh	Starting pixel number. Must be an even number (LSB is treated as 0).	Not used.	Not used.

[†] For CSL implementation, use the notation VP_VCxSTR2_field_symval

B.23.6 Video Capture Channel x Field 2 Stop Register (VCASTOP2, VCBSTOP2)

The video capture channel x field 2 stop register (VCASTOP2, VCBSTOP2) defines the end of the field 2-captured image. VCxSTOP2 is shown in Figure B-304 and described in Table B-322.

These registers are not used in raw data mode or TSI mode because their capture sizes are completely defined by the field 1 start and stop registers.

Figure B-304. Video Capture Channel x Field 2 Stop Register (VCASTOP2, VCBSTOP2)

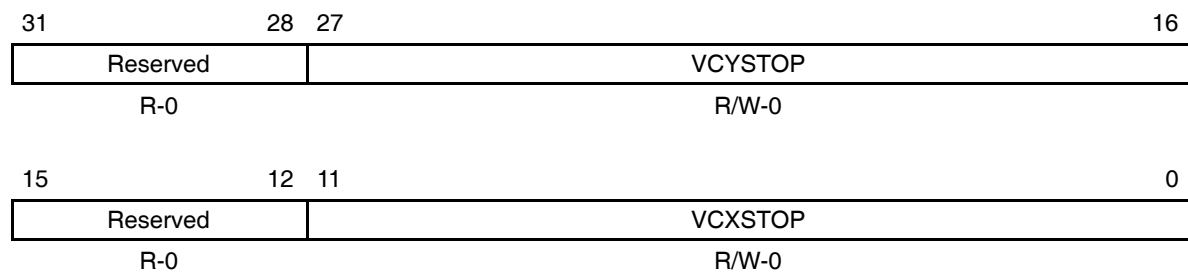

Legend: R = Read only; R/W = Read/Write; -n = value after reset

Table B-322. Video Capture Channel x Field 2 Stop Register (VCxSTOP2) Field Values

Bit	field [†]	symval [†]	Value	Description		
				BT.656 or Y/C Mode	Raw Data Mode	TSI Mode
31-28	Reserved	-	0	Reserved. The reserved bit location is always read as 0. A value written to this field has no effect.		
27-16	VCYSTOP	OF(value)	0-FFFh	Last captured line.	Not used.	Not used.
15-12	Reserved	-	0	Reserved. The reserved bit location is always read as 0. A value written to this field has no effect.		
11-0	VCXSTOP	OF(value)	0-FFFh	Last captured pixel (VCXSTOP - 1). Must be an even value (the LSB is treated as 0).	Not used.	Not used.

[†] For CSL implementation, use the notation VP_VCxSTOP2_field_symval

B.23.7 Video Capture Channel x Vertical Interrupt Register (VCAVINT, VCBVINT)

The video capture channel x vertical interrupt register (VCAVINT, VCBVINT) controls the generation of vertical interrupts in each field. VCxVINT is shown in Figure B–305 and described in Table B–323.

In BT.656 or Y/C mode, an interrupt can be generated upon completion of the specified line in a field (end of line when VCOUNT = VINT n). This allows the software to synchronize to the frame or field. The interrupt can be programmed to occur in one or both fields (or not at all) using the VIF1 and VIF2 bits. The VINT n bits also determine when the FSYNC bit in VCxSTAT is cleared. If FSCL2 is 0, then the FSYNC bit is cleared in field 1 when VCOUNT = VINT1; if FSCL2 is 1, then the FSYNC bit is cleared in field 2 when VCOUNT = VINT2.

Figure B–305. Video Capture Channel x Vertical Interrupt Register (VCAVINT, VCBVINT)

31	30	29	28	27	16
VIF2	FSCL2	Reserved	VINT2		
R/W-0	R/W-0	R-0	R/W-0		
15	14	12	11	0	
VIF1	Reserved		VINT1		
R/W-0	R-0		R/W-0		

Legend: R = Read only; R/W = Read/Write; - n = value after reset

Table B–323. Video Capture Channel *x* Vertical Interrupt Register (VCxVINT) Field Values

Bit	field [†]	symval [†]	Value	Description		
				BT.656 or Y/C Mode	Raw Data Mode	TSI Mode
31	VIF2			Setting of VINT in field 2 enable bit.		
		DISABLE	0	Setting of VINT in field 2 is disabled.	Not used.	Not used.
		ENABLE	1	Setting of VINT in field 2 is enabled.	Not used.	Not used.
30	FSCL2			FSYNC bit cleared in field 2 enable bit.		
		NONE	0	FSYNC bit is not cleared.	Not used.	Not used.
		FIELD2	1	FSYNC bit is cleared in field 2 instead of field 1.	Not used.	Not used.
29–28	Reserved	–	0	Reserved. The reserved bit location is always read as 0. A value written to this field has no effect.		
27–16	VINT2	OF(value)	0–FFFh	Line that vertical interrupt occurs if VIF2 bit is set.	Not used.	Not used.
15	VIF1			Setting of VINT in field 1 enable bit.		
		DISABLE	0	Setting of VINT in field 1 is disabled.	Not used.	Not used.
		ENABLE	1	Setting of VINT in field 1 is enabled.	Not used.	Not used.
14–12	Reserved	–	0	Reserved. The reserved bit location is always read as 0. A value written to this field has no effect.		
11–0	VINT1	OF(value)	0–FFFh	Line that vertical interrupt occurs if VIF1 bit is set.	Not used.	Not used.

[†] For CSL implementation, use the notation VP_VCxVINT_field_symval

B.23.8 Video Capture Channel x Threshold Register (VCATHRLD, VCBTHRLD)

The video capture channel x threshold register (VCATHRLD, VCBTHRLD) determines when DMA requests are sent. VCxTHRLD is shown in Figure B–306 and described in Table B–324.

The VCTHRLD1 bits determine when capture DMA events are generated. Once the threshold is reached, generation of further DMA events is disabled until service of the previous event(s) begins (the first FIFO read by the DMA occurs).

In BT.656 and Y/C modes, every two captured pixels represent 2 luma values in the Y FIFO and 2 chroma values (1 each in the Cb and Cr FIFOs). Depending on the data size and packing mode, each value may be a byte (8-bit BT.656 or Y/C), half-word (10-bit BT.656 or Y/C), or subword (dense pack 10-bit BT.656 or Y/C) within the FIFOs. Therefore, the VCTHRLD1 doubleword number represents 8 pixels in 8-bit modes, 4 pixels in 10-bit modes, or 6 pixels in dense pack 10-bit modes. Since the Cb and Cr FIFO thresholds are represented by $\frac{1}{2}$ VCTHRLD1, certain restrictions are placed on what VCTHRLD1 values are valid.

In raw data mode, each data sample may occupy a byte (8-bit raw mode), half-word (10-bit or 16-bit raw mode), subword (dense pack 10-bit raw mode), or word (20-bit raw mode) within the FIFO, depending on the data size and packing mode. Therefore, the VCTHRLD1 doubleword number represents 8 samples, 4 samples, 6 samples, or 2 samples, respectively.

In TSI mode, VCTHRLD1 represents groups of 8 samples with each sample occupying a byte in the FIFO.

The VCTHRLD2 bits behave identically to VCTHRLD1, but are used during field 2 capture. It is only used if the field 2 DMA size needs to be different from the field 1 DMA size for some reason (for example, different captured line lengths in field 1 and field 2). If VT2EN is not set, then the VCTHRLD1 value is used for both fields.

Note that the VCTHRLD n applies to data being written into the FIFO. In the case of 8-bit BT.656 or Y/C modes, this means the output of any selected filter.

Figure B–306. Video Capture Channel *x* Threshold Register (VCATHRLD, VCBTHRLD)

31	Reserved	26 25	VCTHRLD2	16
	R-0		R/W-0	
15	Reserved	10 9	VCTHRLD1	0
	R-0		R/W-0	

Legend: R = Read only; R/W = Read/Write; -*n* = value after reset

Table B–324. Video Capture Channel *x* Threshold Register (VCxTHRLD) Field Values

Bit	field [†]	symval [†]	Value	Description		
				BT.656 or Y/C Mode	Raw Data Mode	TSI Mode
31–26	Reserved	–	0	Reserved. The reserved bit location is always read as 0. A value written to this field has no effect.		
25–16	VCTHRLD2	OF(<i>value</i>)	0–3FFh	Number of field 2 doublewords required to generate DMA events.	Not used.	Not used.
15–10	Reserved	–	0	Reserved. The reserved bit location is always read as 0. A value written to this field has no effect.		
9–0	VCTHRLD1	OF(<i>value</i>)	0–3FFh	Number of field 1 doublewords required to generate DMA events.	Number of raw data doublewords required to generate a DMA event.	Number of doublewords required to generate a DMA event.

[†] For CSL implementation, use the notation VP_VCxTHRLD_VCTHRLD*n*_symval

B.23.9 Video Capture Channel *x* Event Count Register (VCAEVTCT, VCBEVTCT)

The video capture channel *x* event count register (VCAEVTCT, VCBEVTCT) is programmed with the number of DMA events to be generated for each capture field. VC*x*EVTCT is shown in Figure B–307 and described in Table B–325.

An event counter tracks how many events have been generated and indicates which threshold value (VCTHRLD1 or VCTHRLD2 in VC*x*THRLD) to use in event generation and in the outgoing data counter. Once the CAPEVTCT*n* number of events have been generated, the DMA logic switches to the other threshold value.

Figure B–307. Video Capture Channel *x* Event Count Register (VCAEVTCT, VCBEVTCT)

31		28	27		16
Reserved		CAPEVTCT2			
R-0		R/W-0			
15		12	11		0
Reserved		CAPEVTCT1			
R-0		R/W-0			

Legend: R = Read only; R/W = Read/Write; -*n* = value after reset

Table B–325. Video Capture Channel *x* Event Count Register (VC*x*EVTCT) Field Values

Bit	field [†]	symval [†]	Value	Description		
				BT.656 or Y/C Mode	Raw Data Mode	TSI Mode
31–28	Reserved	–	0	Reserved. The reserved bit location is always read as 0. A value written to this field has no effect.		
27–16	CAPEVTCT2	OF(<i>value</i>)	0–FFFh	Number of DMA event sets (YEVT, CbEVT, CrEVT) to be generated for field 2 capture.	Not used.	Not used.
15–12	Reserved	–	0	Reserved. The reserved bit location is always read as 0. A value written to this field has no effect.		
11–0	CAPEVTCT1	OF(<i>value</i>)	0–FFFh	Number of DMA event sets (YEVT, CbEVT, CrEVT) to be generated for field 1 capture.	Not used.	Not used.

[†] For CSL implementation, use the notation VP_VC*x*EVTCT_CAPEVTCT*n*_symval

B.23.10 Video Capture Channel B Control Register (VCBCTL)

Video capture is controlled by the video capture channel B control register (VCBCTL) shown in Figure B–308 and described in Table B–326.

Figure B–308. Video Capture Channel B Control Register (VCBCTL)

31	30	29					24	
RSTCH	BLKCAP	Reserved						
R/WS-0	R/W-1	R-0						
		23	21	20	19	18	17	16
		Reserved		FINV	Reserved		VRST	HRST
		R-0		R/W-0	R-0		R/W-1	R/W-0
15	14	13	12	11	10	9	8	
VCEN	PK10B		LFDE	SFDE	RESMPL	Reserved	SCALE	
R/W-0	R/W-0		R/W-0	R/W-0	R/W-0	R-0	R/W-0	
7	6	5	4	3	2	1	0	
CON	FRAME	CF2	CF1	Reserved		CMODE		
R/W-0	R/W-0	R/W-1	R/W-1	R-0		R/W-0		

Legend: R = Read only; R/W = Read/Write; WS = Write 1 to reset, write of 0 has no effect; -n = value after reset

Table B–326. Video Capture Channel B Control Register (VCBCTL)
Field Values

Bit	field [†]	symval [†]	Value	Description		
				BT.656 or Y/C Mode	Raw Data Mode	TSI Mode
31	RSTCH			Reset channel bit. Write 1 to reset the bit, a write of 0 has no effect.		
		NONE	0	No effect.		
		RESET	1	Resets the channel by blocking further DMA event generation and flushing the FIFO upon completion of any pending DMAs. Also clears the VCEN bit. All channel registers are set to their initial values. RSTCH is autocleared after channel reset is complete.		

[†] For CSL implementation, use the notation VP_VCBCTL_field_symval

[‡] For complete encoding of these bits, see TMS320C64x DSP Video Port/VCXO Interpolated Control (VIC) Port Reference Guide (SPRU629).

**Table B–326. Video Capture Channel B Control Register (VCBCTL)
Field Values (Continued)**

Bit	field [†]	symval [†]	Value	Description		
				BT.656 or Y/C Mode	Raw Data Mode	TSI Mode
30	BLKCAP			Block capture events bit. BLKCAP functions as a capture FIFO reset without affecting the current programmable register values. The F1C, F2C, and FRMC status bits, in VCBSTAT, are not updated. Field or frame complete interrupts and vertical interrupts are also not generated. Clearing BLKCAP does not enable DMA events during the field where the bit is cleared. Whenever BLKCAP is set and then cleared, the software needs to clear the field and frame status bits (F1C, F2C, and FRMC) as part of the BLKCAP clear operation.		
		CLEAR	0	Enables DMA events in the video frame that follows the video frame where the bit is cleared. (The capture logic must sync to the start of the next frame after BLKCAP is cleared.)		
		BLOCK	1	Blocks DMA events and flushes the capture channel FIFOs.		
29–21	Reserved	–	0	Reserved. The reserved bit location is always read as 0. A value written to this field has no effect.		
20	FINV			Detected field invert bit.		
		FIELD1	0	Detected 0 is field 1.	Not used.	Not used.
		FIELD2	1	Detected 0 is field 2.	Not used.	Not used.
19–18	Reserved	–	0	Reserved. The reserved bit location is always read as 0. A value written to this field has no effect.		
17	VRST			VCOUNT reset method bit.		
		V1EAV	0	Start of vertical blank (1 st V = 1 EAV or VCTL1 active edge)	Not used.	Not used.
		V0EAV	1	End of vertical blank (1 st V = 0 EAV or VCTL1 inactive edge)	Not used.	Not used.

[†] For CSL implementation, use the notation VP_VCBCTL_field_symval

[‡] For complete encoding of these bits, see *TMS320C64x DSP Video Port/VCXO Interpolated Control (VIC) Port Reference Guide* (SPRU629).

**Table B–326. Video Capture Channel B Control Register (VCBCTL)
Field Values (Continued)**

Bit	field [†]	symval [†]	Value	Description		
				BT.656 or Y/C Mode	Raw Data Mode	TSI Mode
16	HRST			HCOUNT reset method bit.		
		EAV	0	EAV or VCTL0 active edge.	Not used.	Not used.
		SAV	1	SAV or VCTL0 inactive edge.	Not used.	Not used.
15	VCEN			Video capture enable bit. Other bits in VCBCTL (except RSTCH and BLKCAP bits) may only be changed when VCEN = 0.		
		DISABLE	0	Video capture is disabled.		
		ENABLE	1	Video capture is enabled.		
14–13	PK10B		0–3h	10-bit packing format select bit.		
		ZERO	0	Zero extend	Zero extend	Not used.
		SIGN	1h	Sign extend	Sign extend	Not used.
		DENSEPK	2h	Dense pack (zero extend)	Dense pack (zero extend)	Not used.
		–	3h	Reserved	Reserved	Not used.
12	LFDE			Long field detect enable bit.		
		DISABLE	0	Long field detect is disabled.	Not used.	Not used.
		ENABLE	1	Long field detect is enabled.	Not used.	Not used.
11	SFDE			Short field detect enable bit.		
		DISABLE	0	Short field detect is disabled.	Not used.	Not used.
		ENABLE	1	Short field detect is enabled.	Not used.	Not used.

[†] For CSL implementation, use the notation VP_VCBCTL_field_symval

[‡] For complete encoding of these bits, see *TMS320C64x DSP Video Port/VCXO Interpolated Control (VIC) Port Reference Guide* (SPRU629).

**Table B–326. Video Capture Channel B Control Register (VCBCTL)
Field Values (Continued)**

Bit	field [†]	symval [†]	Value	Description		
				BT.656 or Y/C Mode	Raw Data Mode	TSI Mode
10	RESMPL			Chroma resampling enable bit.		
		DISABLE	0	Chroma resampling is disabled.	Not used.	Not used.
		ENABLE	1	Chroma is horizontally resampled from 4:2:2 co-sited to 4:2:0 interspersed before saving to chroma buffers.	Not used.	Not used.
9	Reserved	–	0	Reserved. The reserved bit location is always read as 0. A value written to this field has no effect.		
8	SCALE			Scaling select bit.		
		NONE	0	No scaling	Not used.	Not used.
		HALF	1	½ scaling	Not used.	Not used.
7	CON [‡]			Continuous capture enable bit.		
		DISABLE	0	Continuous capture is disabled.		
		ENABLE	1	Continuous capture is enabled.		
6	FRAME [‡]			Capture frame (data) bit.		
		NONE	0	Do not capture frame.	Do not capture single data block.	Do not capture single packet.
		FRMCAP	1	Capture frame.	Capture single data block.	Capture single packet.
5	CF2 [‡]			Capture field 2 bit.		
		NONE	0	Do not capture field 2.	Not used.	Not used.
		FLDCAP	1	Capture field 2.	Not used.	Not used.

[†] For CSL implementation, use the notation `VP_VCBCTL_field_symval`

[‡] For complete encoding of these bits, see *TMS320C64x DSP Video Port/VCXO Interpolated Control (VIC) Port Reference Guide* (SPRU629).

**Table B–326. Video Capture Channel B Control Register (VCBCTL)
Field Values (Continued)**

Bit	field [†]	symval [†]	Value	Description		
				BT.656 or Y/C Mode	Raw Data Mode	TSI Mode
4	CF1 [‡]			Capture field 1 bit.		
		NONE	0	Do not capture field 1.	Not used.	Not used.
		FLDCAP	1	Capture field 1.	Not used.	Not used.
3–2	Reserved	–	0	Reserved. The reserved bit location is always read as 0. A value written to this field has no effect.		
1–0	CMODE		0–3h	Capture mode select bit.		
		BT656B	0	Enables 8-bit BT.656 mode.		Not used.
		BT656D	1h	Enables 10-bit BT.656 mode.		Not used.
		RAWB	2h	Enables 8-bit raw data mode.		Not used.
		RAWD	3h	Enables 10-bit raw data mode.		Not used.

[†] For CSL implementation, use the notation `VP_VCBCTL_field_symval`

[‡] For complete encoding of these bits, see *TMS320C64x DSP Video Port/VCXO Interpolated Control (VIC) Port Reference Guide* (SPRU629).

B.23.11 TSI Capture Control Register (TSICTL)

The transport stream interface capture control register (TSICTL) controls TSI capture operation. TSICTL is shown in Figure B–309 and described in Table B–327.

The ERRFILT, STEN, and TCKEN bits may be written at any time. To ensure stable counter operation, writes to the CTMODE bit are disabled unless the system time counter is halted (ENSTC = 0).

Figure B–309. TSI Capture Control Register (TSICTL)

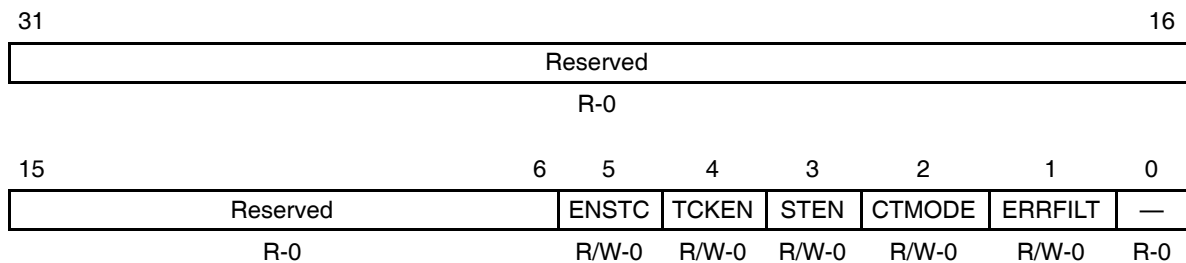

Legend: R = Read only; R/W = Read/Write; -n = value after reset

Table B–327. TSI Capture Control Register (TSICTL) Field Values

Bit	field [†]	symval [†]	Value	Description	
				BT.656, Y/C Mode, or Raw Data Mode	TSI Mode
31–6	Reserved	–	0	Reserved. The reserved bit location is always read as 0. A value written to this field has no effect.	
5	ENSTC			System time clock enable bit.	
		HALTED	0	Not used.	System time clock input is disabled (to save power). The system time clock counters and tick counter do not increment.
		CLKED	1	Not used.	System time input is enabled. The system time clock counters and tick counters are incremented by STCLK.
4	TCKEN			Tick count interrupt enable bit.	
		DISABLE	0	Not used.	Setting of the TICK bit is disabled.
		SET	1	Not used.	The TICK bit in VPIS is set whenever the tick count is reached.

Table B–327. TSI Capture Control Register (TSICTL) Field Values (Continued)

Bit	field [†]	symval [†]	Value	Description	
				BT.656, Y/C Mode, or Raw Data Mode	TSI Mode
3	STEN			System time clock interrupt enable bit.	
		DISABLE	0	Not used.	Setting of the STC bit is disabled.
		SET	1	Not used.	A valid STC compare sets the STC bit in VPIS.
2	CTMODE			Counter mode select bit.	
		90KHZ	0	Not used.	The 33-bit PCR portion of the system time counter increments at 90 kHz (when PCRE rolls over from 299 to 0).
		STCLK	1	Not used.	The 33-bit PCR portion of the system time counter increments by the STCLK input.
1	ERRFILT			Error filtering enable bit.	
		ACCEPT	0	Not used.	Packets with errors are received and the PERR bit is set in the timestamp inserted at the end of the packet.
		REJECT	1	Not used.	Packets with errors are filtered out (not received in the FIFO).
0	Reserved	–	0	Reserved. The reserved bit location is always read as 0. A value written to this field has no effect.	

[†] For CSL implementation, use the notation VP_TSICTL_field_symval

B.23.12 TSI Clock Initialization LSB Register (TSICLKINITL)

The transport stream interface clock initialization LSB register (TSICLKINITL) is used to initialize the hardware counter to synchronize with the system time clock. TSICLKINITL is shown in Figure B–310 and described in Table B–328.

On receiving the first packet containing a program clock reference (PCR) and the PCR extension value, the DSP writes the 32 least-significant bits (LSBs) of the PCR into TSICLKINITL. This initializes the counter to the system time clock. TSICLKINITL should also be updated by the DSP whenever a discontinuity in the PCR field is detected.

To ensure synchronization and prevent false compare detection, the software should disable the system time clock interrupt (clear the STEN bit in TSICTL) prior to writing to TSICLKINITL. All bits of the system time counter are initialized whenever either TSICLKINITL or TSICLKINITM are written.

Figure B–310. TSI Clock Initialization LSB Register (TSICLKINITL)

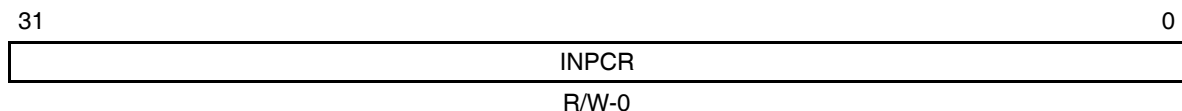

Legend: R/W = Read/Write; -n = value after reset

Table B–328. TSI Clock Initialization LSB Register (TSICLKINITL) Field Values

Bit	Field	symval [†]	Value	Description	
				BT.656, Y/C Mode, or Raw Data Mode	TSI Mode
31–0	INPCR	OF(value)	0–FFFF FFFFh	Not used.	Initializes the 32 LSBs of the system time clock.

[†] For CSL implementation, use the notation VP_TSICLKINITL_INPCR_symval

B.23.13 TSI Clock Initialization MSB Register (TSICLKINITM)

The transport stream interface clock initialization MSB register (TSICLKINITM) is used to initialize the hardware counter to synchronize with the system time clock. TSICLKINITM is shown in Figure B–311 and described in Table B–329.

On receiving the first packet containing a program clock reference (PCR) header, the DSP writes the most-significant bit (MSB) of the PCR and the 9-bit PCR extension into TSICLKINITM. This initializes the counter to the system time clock. TSICLKINITM should also be updated by the DSP whenever a discontinuity in the PCR field is detected.

To ensure synchronization and prevent false compare detection, the software should disable the system time clock interrupt (clear the STEN bit in TSICLTL) prior to writing to TSICLKINITM. All bits of the system time counter are initialized whenever either TSICLKINITL or TSICLKINITM are written.

Figure B–311. TSI Clock Initialization MSB Register (TSICLKINITM)

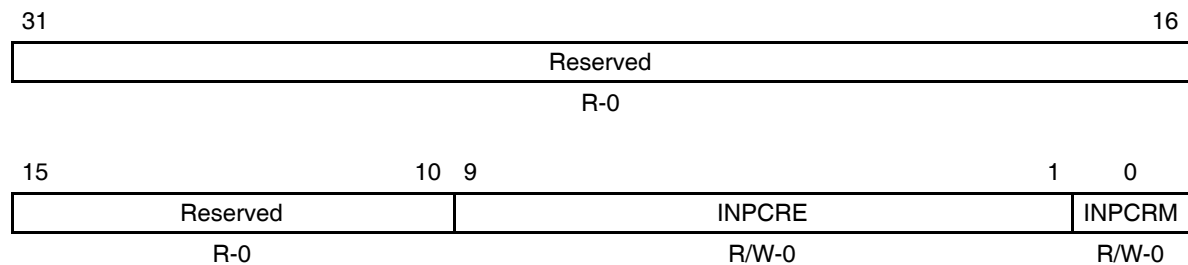

Legend: R = Read only; R/W = Read/Write; -n = value after reset

Table B–329. TSI Clock Initialization MSB Register (TSICLKINITM) Field Values

				Description	
Bit	field [†]	symval [†]	Value	BT.656, Y/C Mode, or Raw Data Mode	TSI Mode
31–10	Reserved	–	0	Reserved.	Reserved. The reserved bit location is always read as 0. A value written to this field has no effect.
9–1	INPCRE	OF(value)	0–1FFh	Not used.	Initializes the extension portion of the system time clock.
0	INPCRM	OF(value)	0–1	Not used.	Initializes the MSB of the system time clock.

[†] For CSL implementation, use the notation VP_TSICLKINITM_field_symval

B.23.14 TSI System Time Clock LSB Register (TSISTCLKL)

The transport stream interface system time clock LSB register (TSISTCLKL) contains the 32 least-significant bits (LSBs) of the program clock reference (PCR). The system time clock value is obtained by reading TSISTCLKL and TSISTCLKM. TSISTCLKL is shown in Figure B–312 and described in Table B–330.

TSISTCLKL represents the current value of the 32 LSBs of the base PCR that normally counts at a 90-kHz rate. Since the system time clock counter continues to count, the DSP may need to read TSISTCLKL twice in a row to ensure an accurate value.

Figure B–312. TSI System Time Clock LSB Register (TSISTCLKL)

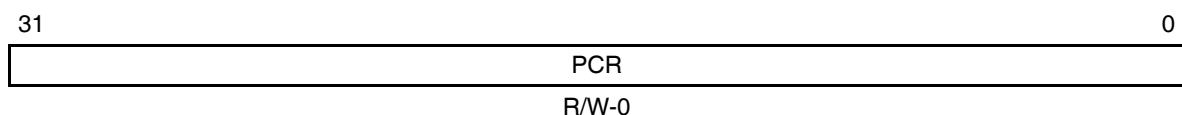

Legend: R/W = Read/Write; -n = value after reset

Table B–330. TSI System Time Clock LSB Register (TSISTCLKL) Field Values

Bit	Field	symval [†]	Value	Description	
				BT.656, Y/C Mode, or Raw Data Mode	TSI Mode
31–0	PCR	OF(value)	0–FFFF FFFFh	Not used.	Contains the 32 LSBs of the program clock reference.

[†] For CSL implementation, use the notation VP_TSISTCLKL_PCR_symval

B.23.15 TSI System Time Clock MSB Register (TSISTCLKM)

The transport stream interface system time clock MSB register (TSISTCLKM) contains the most-significant bit (MSB) of the program clock reference (PCR) and the 9 bits of the PCR extension. The system time clock value is obtained by reading TSISTCLKM and TSISTCLKL. TSISTCLKM is shown in Figure B–313 and described in Table B–331.

The PCRE value changes at a 27-MHz rate and is probably not reliably read by the DSP. The PCRM bit normally changes at a 10.5-μHz rate (every 26 hours).

Figure B–313. TSI System Time Clock MSB Register (TSISTCLKM)

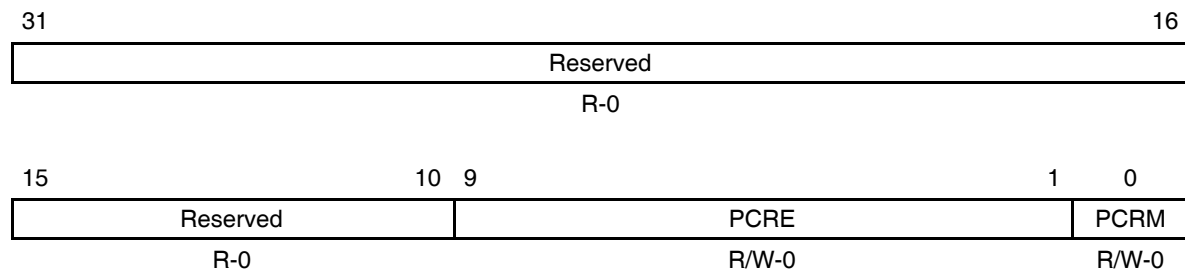

Legend: R = Read only; R/W = Read/Write; -n = value after reset

Table B–331. TSI System Time Clock MSB Register (TSISTCLKM) Field Values

Bit	field†	symval†	Value	Description	
				BT.656, Y/C Mode, or Raw Data Mode	TSI Mode
31–10	Reserved	–	0	Reserved. The reserved bit location is always read as 0. A value written to this field has no effect.	
9–1	PCRE	OF(value)	0–1FFh	Not used.	Contains the extension portion of the program clock reference.
0	PCRM	OF(value)	0–1	Not used.	Contains the MSB of the program clock reference.

† For CSL implementation, use the notation VP_TSISTCLKM_field_symval

B.23.16 TSI System Time Clock Compare LSB Register (TSISTCMPL)

The transport stream interface system time clock compare LSB register (TSISTCMPL) is used to generate an interrupt at some absolute time based on the STC. TSISTCMPL holds the 32 least-significant bits (LSBs) of the absolute time compare (ATC). Whenever the value in TSISTCMPL and TSISTCMPM match the unmasked bits of the time kept by the STC hardware counter and the STEN bit in TSICTL is set, the STC bit in VPIS is set. TSISTCMPL is shown in Figure B–314 and described in Table B–332.

To prevent inaccurate comparisons caused by changing register bits, the software should disable the system time clock interrupt (clear the STEN bit in TSICTL) prior to writing to TSISTCMPL.

Figure B–314. TSI System Time Clock Compare LSB Register (TSISTCMPL)

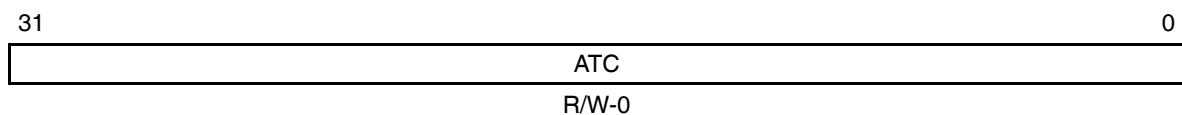

Legend: R/W = Read/Write; -n = value after reset

Table B–332. TSI System Time Clock Compare LSB Register (TSISTCMPL) Field Values

Bit	Field	symval [†]	Value	Description	
				BT.656, Y/C Mode, or Raw Data Mode	TSI Mode
31–0	ATC	OF(value)	0–FFFF FFFFh	Not used.	Contains the 32 LSBs of the absolute time compare.

[†] For CSL implementation, use the notation VP_TSISTCMPL_ATC_symval

B.23.17 TSI System Time Clock Compare MSB Register (TSISTCMPM)

The transport stream interface system time clock compare MSB register (TSISTCMPM) is used to generate an interrupt at some absolute time based on the STC. TSISTCMPM holds the most-significant bit (MSB) of the absolute time compare (ATC). Whenever the value in TSISTCMPM and TSISTCMPL match the unmasked bits of the time kept by the STC hardware counter and the STEN bit in TSICTL is set, the STC bit in VPIS is set. TSISTCMPM is shown in Figure B–315 and described in Table B–333.

To prevent inaccurate comparisons caused by changing register bits, the software should disable the system time clock interrupt (clear the STEN bit in TSICTL) prior to writing to TSISTCMPM.

Figure B–315. TSI System Time Clock Compare MSB Register (TSISTCMPM)

31	Reserved	1	0
	R-0		ATC R/W-0

Legend: R = Read only; R/W = Read/Write; -n = value after reset

Table B–333. TSI System Time Clock Compare MSB Register (TSISTCMPM) Field Values

Bit	Field	symval [†]	Value	Description	
				BT.656, Y/C Mode, or Raw Data Mode	TSI Mode
31–1	Reserved	–	0	Reserved. The reserved bit location is always read as 0. A value written to this field has no effect.	
0	ATC	OF(value)	0–1	Not used.	Contains the MSB of the absolute time compare.

[†] For CSL implementation, use the notation VP_TSISTCMPM_ATC_symval

B.23.18 TSI System Time Clock Compare Mask LSB Register (TSISTMSKL)

The transport stream interface system time clock compare mask LSB register (TSISTMSKL) holds the 32 least-significant bits (LSBs) of the absolute time compare mask (ATCM). This value is used with TSISTMSKM to mask out bits during the comparison of the ATC to the system time clock for absolute time. The bits that are set to one mask the corresponding ATC bits during the compare. TSISTMSKL is shown in Figure B–316 and described in Table B–334.

To prevent inaccurate comparisons caused by changing register bits, the software should disable the system time clock interrupt (clear the STEN bit in TSICTL) prior to writing to TSISTMSKL.

Figure B–316. TSI System Time Clock Compare Mask LSB Register (TSISTMSKL)

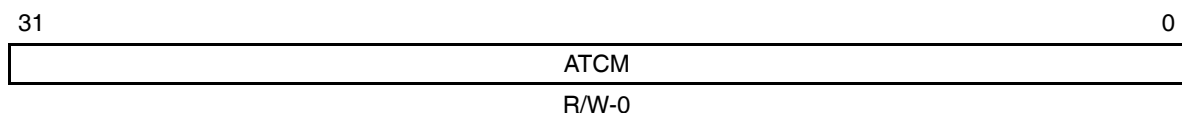

Legend: R/W = Read/Write; -n = value after reset

Table B–334. TSI System Time Clock Compare Mask LSB Register (TSISTMSKL)
Field Values

Bit	Field	symval [†]	Value	Description	
				BT.656, Y/C Mode, or Raw Data Mode	TSI Mode
31–0	ATCM	OF(value)	0–FFFF FFFFh	Not used.	Contains the 32 LSBs of the absolute time compare mask.

[†] For CSL implementation, use the notation VP_TSISTMSKL_ATCM_symval

B.23.19 TSI System Time Clock Compare Mask MSB Register (TSISTMSKM)

The transport stream interface system time clock compare mask MSB register (TSISTMSKM) holds the most-significant bit (MSB) of the absolute time compare mask (ATCM). This value is used with TSISTMSKL to mask out bits during the comparison of the ATC to the system time clock for absolute time. The bits that are set to one mask the corresponding ATC bits during the compare. TSISTMSKM is shown in Figure B–317 and described in Table B–335.

To prevent inaccurate comparisons caused by changing register bits, the software should disable the system time clock interrupt (clear the STEN bit in TSICTL) prior to writing to TSISTMSKM.

Figure B–317. TSI System Time Clock Compare Mask MSB Register (TSISTMSKM)

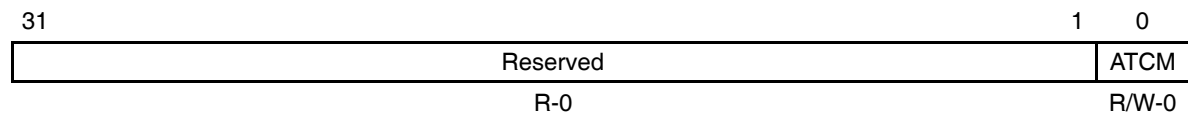

Legend: R = Read only; R/W = Read/Write; -n = value after reset

Table B–335. TSI System Time Clock Compare Mask MSB Register (TSISTMSKM)
Field Values

Bit	Field	symval [†]	Value	Description	
				BT.656, Y/C Mode, or Raw Data Mode	TSI Mode
31–1	Reserved	–	0	Reserved. The reserved bit location is always read as 0. A value written to this field has no effect.	
0	ATCM	OF(value)	0–1	Not used.	Contains the MSB of the absolute time compare mask.

[†] For CSL implementation, use the notation VP_TSISTMSKM_ATCM_symval

B.23.20 TSI System Time Clock Ticks Interrupt Register (TSITICKS)

The transport stream interface system time clock ticks interrupt register (TSITICKS) is used to generate an interrupt after a certain number of ticks of the 27-MHz system time clock. When the TICKCT value is set to X and the TCKEN bit in TSICTL is set, the TICK bit in VPIS is set every $X + 1$ STCLK cycles. Note that the tick interrupt counter and comparison logic function are separate from the PCR logic and always count STCLK cycles regardless of the value of the CTMODE bit in TSICTL. TSITICKS is shown in Figure B–318 and described in Table B–336.

A write to TSITICKS resets the tick counter 0. Whenever the tick counter reaches the TICKCT value, the TICK bit in VPIS is set and the counter resets to 0.

To prevent inaccurate comparisons caused by changing register bits, the software should disable the tick count interrupt (clear the TCKEN bit in TSICTL) prior to writing to TSITICKS.

Figure B–318. TSI System Time Clock Ticks Interrupt Register (TSITICKS)

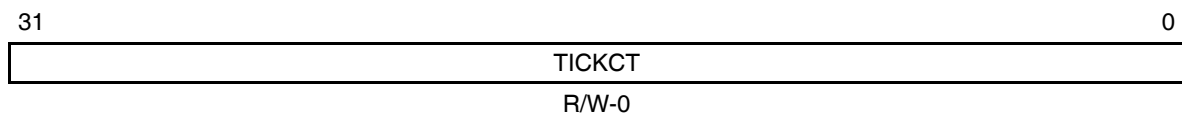

Legend: R/W = Read/Write; -n = value after reset

Table B–336. TSI System Time Clock Ticks Interrupt Register (TSITICKS) Field Values

Bit	Field	symval [†]	Value	Description	
				BT.656, Y/C Mode, or Raw Data Mode	TSI Mode
31–0	TICKCT	OF(value)	0–FFFF FFFFh	Not used.	Contains the number of ticks of the 27-MHz system time clock required to generate a tick count interrupt.

[†] For CSL implementation, use the notation VP_TSITICKS_TICKCT_symval

B.24 Video Display Registers

The registers for controlling the video display mode of operation are listed in Table B–337. See the device-specific datasheet for the memory address of these registers.

Table B–337. Video Display Control Registers

Offset Address [†]	Acronym	Register Name	Section
200h	VDSTAT	Video Display Status Register	B.24.1
204h	VDCTL	Video Display Control Register	B.24.2
208h	VDFRMSZ	Video Display Frame Size Register	B.24.3
20Ch	VDHBLNK	Video Display Horizontal Blanking Register	B.24.4
210h	VDVBLKS1	Video Display Field 1 Vertical Blanking Start Register	B.24.5
214h	VDVBLKE1	Video Display Field 1 Vertical Blanking End Register	B.24.6
218h	VDVBLKS2	Video Display Field 2 Vertical Blanking Start Register	B.24.7
21Ch	VDVBLKE2	Video Display Field 2 Vertical Blanking End Register	B.24.8
220h	VDIMGOFF1	Video Display Field 1 Image Offset Register	B.24.9
224h	VDIMGSZ1	Video Display Field 1 Image Size Register	B.24.10
228h	VDIMGOFF2	Video Display Field 2 Image Offset Register	B.24.11
22Ch	VDIMGSZ2	Video Display Field 2 Image Size Register	B.24.12
230h	VDFLDT1	Video Display Field 1 Timing Register	B.24.13
234h	VDFLDT2	Video Display Field 2 Timing Register	B.24.14
238h	VDTHRLD	Video Display Threshold Register	B.24.15
23Ch	VDHSYNC	Video Display Horizontal Synchronization Register	B.24.16
240h	VDVSYNS1	Video Display Field 1 Vertical Synchronization Start Register	B.24.17
244h	VDVSYNE1	Video Display Field 1 Vertical Synchronization End Register	B.24.18
248h	VDVSYNS2	Video Display Field 2 Vertical Synchronization Start Register	B.24.19
24Ch	VDVSYNE2	Video Display Field 2 Vertical Synchronization End Register	B.24.20
250h	VDRELOAD	Video Display Counter Reload Register	B.24.21

[†] The absolute address of the registers is device/port specific and is equal to the base address + offset address. See the device-specific datasheet to verify the register addresses.

Table B–337. Video Display Control Registers (Continued)

Offset Address [†]	Acronym	Register Name	Section
254h	VDDISPEVT	Video Display Display Event Register	B.24.22
258h	VDCLIP	Video Display Clipping Register	B.24.23
25Ch	VDDEFVAL	Video Display Default Display Value Register	B.24.24
260h	VDVINT	Video Display Vertical Interrupt Register	B.24.25
264h	VDFBIT	Video Display Field Bit Register	B.24.26
268h	VDVBIT1	Video Display Field 1 Vertical Blanking Bit Register	B.24.27
26Ch	VDVBIT2	Video Display Field 2 Vertical Blanking Bit Register	B.24.28

[†] The absolute address of the registers is device/port specific and is equal to the base address + offset address. See the device-specific datasheet to verify the register addresses.

B.24.1 Video Display Status Register (VDSTAT)

The video display status register (VDSTAT) indicates the current display status of the video port. The VDSTAT is shown in Figure B–319 and described in Table B–338.

The VDXPOS and VDYPOS bits track the coordinates of the most-recently displayed pixel. The F1D, F2D, and FRMD bits indicate the completion of fields or frames and may need to be cleared by the DSP to prevent a DCNA interrupt from being generated, depending on the selected frame operation. The F1D, F2D, and FRMD bits are set when the final pixel from the appropriate field has been sent to the output pad.

Figure B–319. Video Display Status Register (VDSTAT)

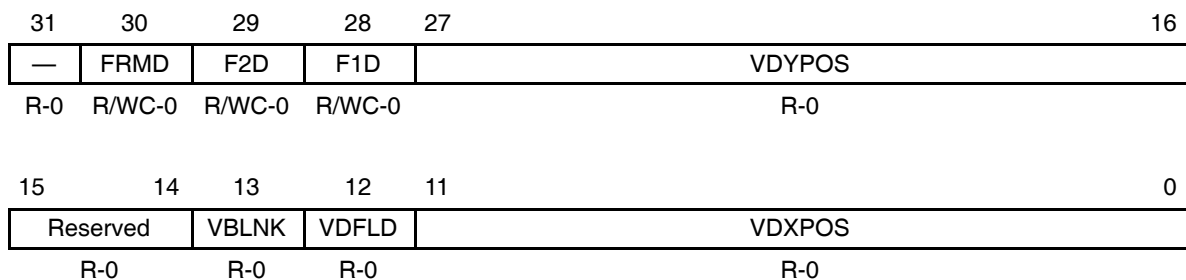

Legend: R = Read only; WC = Write 1 to clear, write of 0 has no effect; -n = value after reset

Table B–338. Video Display Status Register (VDSTAT) Field Values

Bit	field [†]	symval [†]	Value	Description
31	Reserved	–	0	Reserved. The reserved bit location is always read as 0. A value written to this field has no effect.
30	FRMD			Frame displayed bit. Write 1 to clear the bit, a write of 0 has no effect.
		NONE	0	Complete frame has not been displayed.
		DISPLAYED	1	Complete frame has been displayed.
29	F2D			Field 2 displayed bit. Write 1 to clear the bit, a write of 0 has no effect.
		NONE	0	Field 2 has not been displayed.
		DISPLAYED	1	Field 2 has been displayed.
28	F1D			Field 1 displayed bit. Write 1 to clear the bit, a write of 0 has no effect.
		NONE	0	Field 1 has not been displayed.
		DISPLAYED	1	Field 1 has been displayed.
27–16	VDYPOS	OF(<i>value</i>)	0–FFFh	Current frame line counter (FLCOUNT) value. Index of the current line in the current field being displayed by the module.
15–14	Reserved	–	0	Reserved. The reserved bit location is always read as 0. A value written to this field has no effect.
13	VBLNK			Vertical blanking bit.
		EMPTY	0	Video display is not in a vertical-blanking interval.
		NOTEMPTY	1	Video display is in a vertical-blanking interval.
12	VDFLD			VDFLD bit indicates which field is currently being displayed. The VDFLD bit is updated at the start of the vertical blanking interval of the next field.
		FIELD1ACT	0	Field 1 is active.
		FIELD2ACT	1	Field 2 is active.
11–0	VDXPOS	OF(<i>value</i>)	0–FFFh	Current frame pixel counter (FPCOUNT) value. Index of the most recently output pixel.

[†] For CSL implementation, use the notation VD_VDSTAT_*field_symval*

B.24.2 Video Display Control Register (VDCTL)

The video display is controlled by the video display control register (VDCTL). The VDCTL is shown in Figure B–320 and described in Table B–339.

Figure B–320. Video Display Control Register (VDCTL)

31	30	29	28	27	24		
RSTCH	BLKDIS	Reserved	PVPSYN	Reserved			
R/WS-0	R/W-1	R-0	R/W-0	R-0			
23	22	21	20	19	18	17	16
FXS	VXS	HXS	VCTL2S	VCTL1S		VCTL0S	
R/W-0	R/W-0	R/W-0	R/W-0	R/W-0		R/W-0	
15	14	13	12	11	10	9	8
VDEN	DPK	RGBX	RSYNC	DVEN	RESMPL	Reserved	SCALE
R/W-0	R/W-0	R/W-0	R/W-0	R/W-0	R/W-0	R-0	R/W-0
7	6	5	4	3	2	0	
CON	FRAME	DF2	DF1	Reserved	DMODE		
R/W-0	R/W-0	R/W-0	R/W-0	R-0	R/W-0		

Legend: R = Read only; R/W = Read/Write; WS = Write 1 to reset, write of 0 has no effect; -n = value after reset

Table B–339. Video Display Control Register (VDCTL) Field Values

Bit	field [†]	symval [†]	Value	Description	
				BT.656 and Y/C Mode	Raw Data Mode
31	RSTCH			Reset channel bit. Write 1 to reset the bit, a write of 0 has no effect.	
		NONE	0	No effect.	
		RESET	1	Resets the video display module and sets its registers to their initial values. Also clears the VDEN bit. The video display module automatically clears RSTCH after software reset is completed.	

[†] For CSL implementation, use the notation VP_VDCTL_field_symval

[‡] For complete encoding of these bits, see TMS320C64x DSP Video Port/VCXO Interpolated Control (VIC) Port Reference Guide (SPRU629).

Table B–339. Video Display Control Register (VDCTL) Field Values (Continued)

Bit	field [†]	symval [†]	Value	Description	
				BT.656 and Y/C Mode	Raw Data Mode
30	BLKDIS			Block display events bit. BLKDIS functions as a display FIFO reset without affecting the current programmable register values.	
				The video display module continues to function normally, the counters count, control outputs are generated, EAV/SAV codes are generated for BT.656 and Y/C modes, and default or blanking data is output during active display time. No data is moved to the display FIFOs because no events occur. The F1D, F2D, and FRMD bits in VDSTAT are still set when fields or frames are complete.	
		CLEAR	0	Clearing BLKDIS does not enable DMA events during the field in which the bit is cleared. DMA events are enabled at the start of the next frame after the one in which the bit is cleared. This allows the DMA to always be synced to the proper field.	
		BLOCK	1	Blocks DMA events and flushes the display FIFOs.	
29	Reserved	–	0	Reserved. The reserved bit location is always read as 0. A value written to this field has no effect.	
28	PVPSYN			Previous video port synchronization enable bit.	
		DISABLE	0		
		ENABLE	1	Output timing is locked to preceding video port (VP2 is locked to VP1 or VP1 is locked to VP0).	
27–24	Reserved	–	0	Reserved. The reserved bit location is always read as 0. A value written to this field has no effect.	
23	FXS			Field external synchronization enable bit.	
		OUTPUT	0	VCTL2 is an output.	
		FSINPUT	1	VCTL2 is an external field sync input.	
22	VXS			Vertical external synchronization enable bit.	
		OUTPUT	0	VCTL1 is an output.	
		VSINPUT	1	VCTL1 is an external vertical sync input.	

[†] For CSL implementation, use the notation VP_VDCTL_field_symval

[‡] For complete encoding of these bits, see *TMS320C64x DSP Video Port/VCXO Interpolated Control (VIC) Port Reference Guide* (SPRU629).

Table B–339. Video Display Control Register (VDCTL) Field Values (Continued)

Bit	field [†]	symval [†]	Value	Description	
				BT.656 and Y/C Mode	Raw Data Mode
21	HXS			Horizontal external synchronization enable bit.	
		OUTPUT	0	VCTL0 is an output.	
		HSINPUT	1	VCTL0 is an external horizontal sync input.	
20	VCTL2S			VCTL2 output select bit.	
		CBLNK	0	Output CBLNK	
		FLD	1	Output FLD	
19–18	VCTL1S		0–3h	VCTL1 output select bit.	
		VYSYNC	0	Output VSYNC	
		VBLNK	1h	Output VBLNK	
		CSYNC	2h	Output CSYNC	
		FLD	3h	Output FLD	
17–16	VCTL0S		0–3h	VCTL0 output select bit.	
		HYSYNC	0	Output HSYNC	
		HBLNK	1h	Output HBLNK	
		AVID	2h	Output AVID	
		FLD	3h	Output FLD	
15	VDEN			Video display enable bit. Other bits in VDCTL (except RSTCH and BLKDIS bits) may only be changed when VDEN = 0.	
		DISABLE	0	Video display is disabled.	
		ENABLE	1	Video display is enabled.	
14	DPK			10-bit packing format select bit.	
		N10UNPK	0	Normal 10-bit unpacking	
		D10UNPK	1	Dense 10-bit unpacking	

[†] For CSL implementation, use the notation VP_VDCTL_field_symval

[‡] For complete encoding of these bits, see *TMS320C64x DSP Video Port/VCXO Interpolated Control (VIC) Port Reference Guide* (SPRU629).

Table B–339. Video Display Control Register (VDCTL) Field Values (Continued)

Bit	field [†]	symval [†]	Value	Description	
				BT.656 and Y/C Mode	Raw Data Mode
13	RGBX			RGB extract enable bit.	
		DISABLE	0	Not used.	
		ENABLE	1	Not used.	Perform $\frac{3}{4}$ FIFO unpacking.
12	RSYNC			Second, synchronized raw data channel enable bit.	
		DISABLE	0	Not used.	Second, synchronized raw data channel is disabled.
		ENABLE	1	Not used.	Second, synchronized raw data channel is enabled.
11	DVEN			Default value enable bit.	
		BLANKING	0	Blanking value is output during non-sourced active pixels.	Not used.
		DV	1	Default value is output during non-sourced active pixels.	Not used.
10	RESMPL			Chroma resampling enable bit.	
		DISABLE	0	Chroma resampling is disabled.	Not used.
		ENABLE	1	Chroma is horizontally resampled from 4:2:0 interspersed to 4:2:2 co-sited before output.	Not used.
9	Reserved	–	0	Reserved. The reserved bit location is always read as 0. A value written to this field has no effect.	
8	SCALE			Scaling select bit.	
		NONE	0	No scaling	Not used.
		X2	1	2× scaling	Not used.
7	CON [‡]			Continuous display enable bit.	
		DISABLE	0	Continuous display is disabled.	
		ENABLE	1	Continuous display is enabled.	

[†] For CSL implementation, use the notation `VP_VDCTL_field_symval`

[‡] For complete encoding of these bits, see *TMS320C64x DSP Video Port/VIC Interpolated Control (VIC) Port Reference Guide* (SPRU629).

Table B–339. Video Display Control Register (VDCTL) Field Values (Continued)

Bit	field [†]	symval [†]	Value	Description	
				BT.656 and Y/C Mode	Raw Data Mode
6	FRAME [‡]			Display frame bit.	
		NONE	0	Do not display frame.	
		FRMDIS	1	Display frame.	
5	DF2 [‡]			Display field 2 bit.	
		NONE	0	Do not display field 2.	
		FLDDIS	1	Display field 2.	
4	DF1 [‡]			Display field 1 bit.	
		NONE	0	Do not display field 1.	
		FLDDIS	1	Display field 1.	
3	Reserved	–	0	Reserved. The reserved bit location is always read as 0. A value written to this field has no effect.	
2–0	DMODE		0–7h	Display mode select bit.	
		BT656B	0	Enables 8-bit BT.656 mode.	
		BT656D	1h	Enables 10-bit BT.656 mode.	
		RAWB	2h	Enables 8-bit raw data mode.	
		RAWD	3h	Enables 10-bit raw data mode.	
		YC16	4h	Enables 8-bit Y/C mode.	
		YC20	5h	Enables 10-bit Y/C mode.	
		RAW16	6h	Enables 16-bit raw data mode.	
		RAW20	7h	Enables 20-bit raw data mode.	

[†] For CSL implementation, use the notation `VP_VDCTL_field_symval`

[‡] For complete encoding of these bits, see *TMS320C64x DSP Video Port/VCXO Interpolated Control (VIC) Port Reference Guide* (SPRU629).

B.24.3 Video Display Frame Size Register (VDFRMSZ)

The video display frame size register (VDFRMSZ) sets the display channel frame size by setting the ending values for the frame line counter (FLCOUNT) and the frame pixel counter (FPCOUNT). The VDFRMSZ is shown in Figure B–321 and described in Table B–340.

The FPCOUNT starts at 0 and counts to FRMWIDTH – 1 before restarting. The FLCOUNT starts at 1 and counts to FRMHEIGHT before restarting.

Figure B–321. Video Display Frame Size Register (VDFRMSZ)

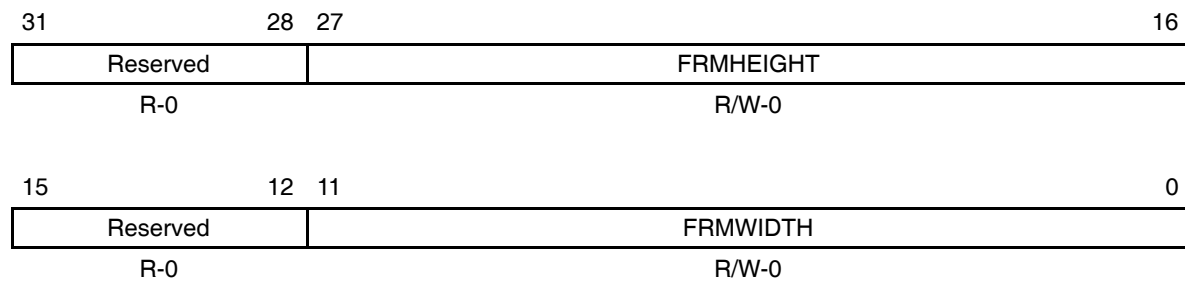

Legend: R = Read only; R/W = Read/Write; -n = value after reset

Table B–340. Video Display Frame Size Register (VDFRMSZ) Field Values

Bit	field [†]	symval [†]	Value	Description
31–28	Reserved	–	0	Reserved. The reserved bit location is always read as 0. A value written to this field has no effect.
27–16	FRMHEIGHT	OF(value)	0–FFFh	Defines the total number of lines per frame. The number is the ending value of the frame line counter (FLCOUNT). For BT.656 operation, the FRMHIGHT is set to 525 (525/60 operation) or 625 (625/50 operation).
15–12	Reserved	–	0	Reserved. The reserved bit location is always read as 0. A value written to this field has no effect.
11–0	FRMWIDTH	OF(value)	0–FFFh	Defines the total number of pixels per line including blanking. The number is the frame pixel counter (FPCOUNT) ending value + 1. For BT.656 operation, the FRMWIDTH is typically 858 or 864.

[†] For CSL implementation, use the notation VP_VDFRMSZ_field_symval

B.24.4 Video Display Horizontal Blanking Register (VDHBLNK)

The video display horizontal blanking register (VDHBLNK) controls the display horizontal blanking. The VDHBLNK is shown in Figure B–322 and described in Table B–341.

Every time the frame pixel counter (FPCOUNT) is equal to HBLNKSTART, HBLNK is asserted. HBLNKSTART also determines where the EAV code is inserted in the BT.656 and Y/C output.

Every time FPCOUNT = HBLNKSTOP, the HBLNK signal is deasserted. In BT.656 and Y/C modes, HBLNKSTOP determines the SAV code insertion point and HBLNK deassertion point. The HBLNK inactive edge may optionally be delayed by 4 pixel clocks using the HBDLA bit.

Figure B–322. Video Display Horizontal Blanking Register (VDHBLNK)

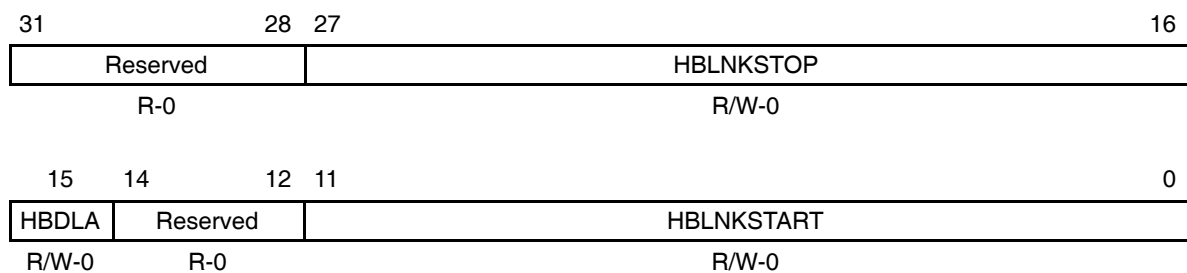

Legend: R = Read only; R/W = Read/Write; -n = value after reset

Table B–341. Video Display Horizontal Blanking Register (VDHBLNK) Field Values

Bit	field [†]	symval [†]	Value	Description	
				BT.656 and Y/C Mode	Raw Data Mode
31–28	Reserved	–	0	Reserved. The reserved bit location is always read as 0. A value written to this field has no effect.	
27–16	HBLNKSTOP	OF(value)	0–FFFh	Location of SAV code and HBLNK inactive edge within the line. HBLNK inactive edge may be optionally delayed by 4 VCLKs.	Ending pixel (FPCOUNT) of blanking video area (HBLNK inactive) within the line.
15	HBDLA			Horizontal blanking delay enable bit.	
		NONE	0	Horizontal blanking delay is disabled.	Not used.
		DELAY	1	HBLNK inactive edge is delayed by 4 VCLKs.	Not used.
14–12	Reserved	–	0	Reserved. The reserved bit location is always read as 0. A value written to this field has no effect.	
11–0	HBLNKSTART	OF(value)	0–FFFh	Location of EAV code and HBLNK active edge within the line.	Starting pixel (FPCOUNT) of blanking video area (HBLNK active) within the line.

[†] For CSL implementation, use the notation VP_VDHBLNK_field_symval

B.24.5 Video Display Field 1 Vertical Blanking Start Register (VDVBLKS1)

The video display field 1 vertical blanking start register (VDVBLKS1) controls the start of vertical blanking in field 1. The VDVBLKS1 is shown in Figure B–323 and described in Table B–342.

In raw data mode, VBLNK is asserted whenever the frame line counter (FLCOUNT) is equal to VBLNKYSTART1 and the frame pixel counter (FPCOUNT) is equal to VBLNKXSTART1.

In BT.656 and Y/C mode, VBLNK is asserted whenever FLCOUNT = VBLNKYSTART1 and FPCOUNT = VBLNKXSTART1. This VBLNK output control is completely independent of the timing control codes. The V bit in the EAV/SAV codes for field 1 is controlled by the VDBIT1 register.

Figure B–323. Video Display Field 1 Vertical Blanking Start Register (VDVBLKS1)

31	28 27	16
Reserved	VBLNKYSTART1	
R-0	R/W-0	
15	12 11	0
Reserved	VBLNKXSTART1	
R-0	R/W-0	

Legend: R = Read only; R/W = Read/Write; -n = value after reset

Table B–342. Video Display Field 1 Vertical Blanking Start Register (VDVBLKS1) Field Values

Bit	field [†]	symval [†]	Value	Description	
				BT.656 and Y/C Mode	Raw Data Mode
31–28	Reserved	–	0	Reserved. The reserved bit location is always read as 0. A value written to this field has no effect.	
27–16	VBLNKYSTART1	OF(value)	0–FFFh	Specifies the line (in FLCOUNT) where VBLNK active edge occurs for field 1. Does not affect EAV/SAV V bit operation.	Specifies the line (in FLCOUNT) where vertical blanking begins (VBLNK active edge) for field 1.
15–12	Reserved	–	0	Reserved. The reserved bit location is always read as 0. A value written to this field has no effect.	
11–0	VBLNKXSTART1	OF(value)	0–FFFh	Specifies the pixel (in FPCOUNT) where VBLNK active edge occurs for field 1.	Specifies the pixel (in FPCOUNT) where vertical blanking begins (VBLNK active edge) for field 1.

[†] For CSL implementation, use the notation VP_VDVBLKS1_field_symval

B.24.6 Video Display Field 1 Vertical Blanking End Register (VDVBLKE1)

The video display field 1 vertical blanking end register (VDVBLKE1) controls the end of vertical blanking in field 1. The VDVBLKE1 is shown in Figure B-324 and described in Table B-343.

In raw data mode, VBLNK is deasserted whenever the frame line counter (FLCOUNT) is equal to VBLNKYSTOP1 and the frame pixel counter (FPCOUNT) is equal to VBLNKXSTOP1.

In BT.656 and Y/C mode, VBLNK is deasserted whenever $FLCOUNT = VBLNKYSTOP1$ and $FPCOUNT = VBLNKXSTOP1$. This VBLNK output control is completely independent of the timing control codes. The V bit in the EAV/SAV codes for field 1 is controlled by the VDVBIT1 register.

Figure B-324. Video Display Field 1 Vertical Blanking End Register (VDVBLKE1)

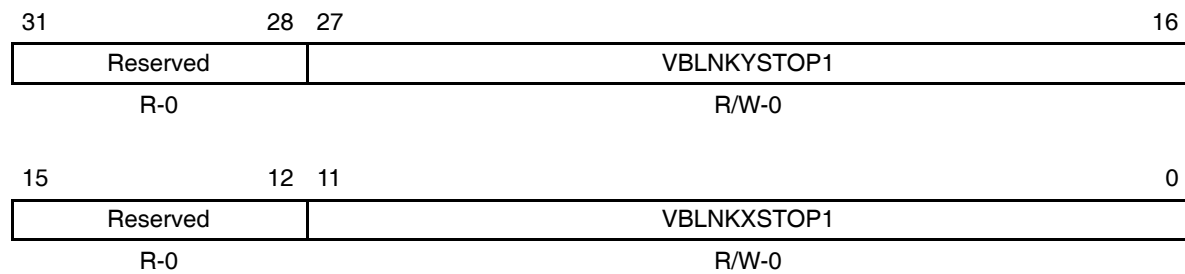

Legend: R = Read only; R/W = Read/Write; -n = value after reset

Table B–343. Video Display Field 1 Vertical Blanking End Register (VDVBLKE1)
Field Values

Bit	field [†]	symval [†]	Value	Description	
				BT.656 and Y/C Mode	Raw Data Mode
31–28	Reserved	–	0	Reserved. The reserved bit location is always read as 0. A value written to this field has no effect.	
27–16	VBLNKYSTOP1	OF(value)	0–FFFh	Specifies the line (in FLCOUNT) where VBLNK inactive edge occurs for field 1. Does not affect EAV/SAV V bit operation.	Specifies the line (in FLCOUNT) where vertical blanking ends (VBLNK inactive edge) for field 1.
15–12	Reserved	–	0	Reserved. The reserved bit location is always read as 0. A value written to this field has no effect.	
11–0	VBLNKXSTOP1	OF(value)	0–FFFh	Specifies the pixel (in FPCOUNT) where VBLNK inactive edge occurs for field 1.	Specifies the pixel (in FPCOUNT) where vertical blanking ends (VBLNK inactive edge) for field 1.

[†] For CSL implementation, use the notation VP_VDVBLKE1_field_symval

B.24.7 Video Display Field 2 Vertical Blanking Start Register (VDVBLKS2)

The video display field 2 vertical blanking start register (VDVBLKS2) controls the start of vertical blanking in field 2. The VDVBLKS2 is shown in Figure B–325 and described in Table B–344.

In raw data mode, VBLNK is asserted whenever the frame line counter (FLCOUNT) is equal to VBLNKYSTART2 and the frame pixel counter (FPCOUNT) is equal to VBLNKXSTART2.

In BT.656 and Y/C mode, VBLNK is asserted whenever FLCOUNT = VBLNKYSTART2 and FPCOUNT = VBLNKXSTART2. This VBLNK output control is completely independent of the timing control codes. The V bit in the EAV/SAV codes for field 2 is controlled by the VDVBIT2 register.

Figure B–325. Video Display Field 2 Vertical Blanking Start Register (VDVBLKS2)

31	28 27	16
Reserved	VBLNKYSTART2	
R-0	R/W-0	
15	12 11	0
Reserved	VBLNKXSTART2	
R-0	R/W-0	

Legend: R = Read only; R/W = Read/Write; -n = value after reset

Table B–344. Video Display Field 2 Vertical Blanking Start Register (VDVBLKS2) Field Values

Bit	field [†]	symval [†]	Value	Description	
				BT.656 and Y/C Mode	Raw Data Mode
31–28	Reserved	–	0	Reserved. The reserved bit location is always read as 0. A value written to this field has no effect.	
27–16	VBLNKYSTART2	OF(value)	0–FFFh	Specifies the line (in FLCOUNT) where VBLNK active edge occurs for field 2. Does not affect EAV/SAV V bit operation.	Specifies the line (in FLCOUNT) where vertical blanking begins (VBLNK active edge) for field 2.
15–12	Reserved	–	0	Reserved. The reserved bit location is always read as 0. A value written to this field has no effect.	
11–0	VBLNKXSTART2	OF(value)	0–FFFh	Specifies the pixel (in FPCOUNT) where VBLNK active edge occurs for field 2.	Specifies the pixel (in FPCOUNT) where vertical blanking begins (VBLNK active edge) for field 2.

[†] For CSL implementation, use the notation VP_VDVBLKS2_field_symval

B.24.8 Video Display Field 2 Vertical Blanking End Register (VDVBLKE2)

The video display field 2 vertical blanking end register (VDVBLKE2) controls the end of vertical blanking in field 2. The VDVBLKE2 is shown in Figure B–326 and described in Table B–345.

In raw data mode, VBLNK is deasserted whenever the frame line counter (FLCOUNT) is equal to VBLNKYSTOP2 and the frame pixel counter (FPCOUNT) is equal to VBLNKXSTOP2.

In BT.656 and Y/C mode, VBLNK is deasserted whenever $FLCOUNT = VBLNKYSTOP2$ and $FPCOUNT = VBLNKXSTOP2$. This VBLNK output control is completely independent of the timing control codes. The V bit in the EAV/SAV codes for field 2 is controlled by the VDVBIT2 register.

Figure B–326. Video Display Field 2 Vertical Blanking End Register (VDVBLKE2)

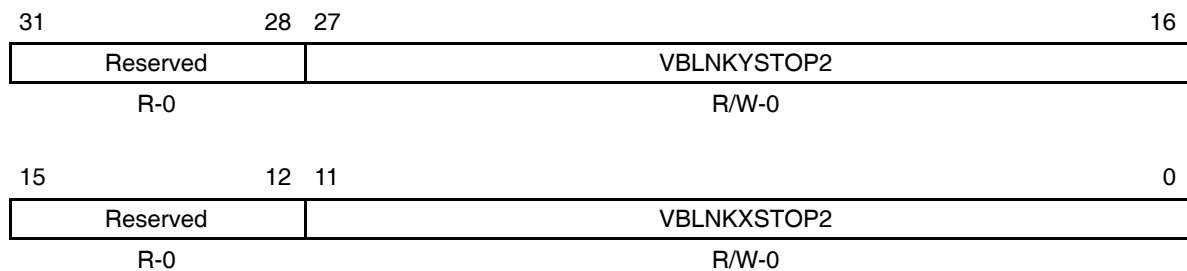

Legend: R = Read only; R/W = Read/Write; -n = value after reset

Table B–345. Video Display Field 2 Vertical Blanking End Register (VDVBLKE2) Field Values

Bit	field†	symval†	Value	Description	
				BT.656 and Y/C Mode	Raw Data Mode
31–28	Reserved	–	0	Reserved. The reserved bit location is always read as 0. A value written to this field has no effect.	
27–16	VBLNKYSTOP2	OF(<i>value</i>)	0–FFFh	Specifies the line (in FLCOUNT) where VBLNK inactive edge occurs for field 2. Does not affect EAV/SAV V bit operation.	Specifies the line (in FLCOUNT) where vertical blanking ends (VBLNK inactive edge) for field 2.
15–12	Reserved	–	0	Reserved. The reserved bit location is always read as 0. A value written to this field has no effect.	
11–0	VBLNKXSTOP2	OF(<i>value</i>)	0–FFFh	Specifies the pixel (in FPCOUNT) where VBLNK inactive edge occurs for field 2.	Specifies the pixel (in FPCOUNT) where vertical blanking ends (VBLNK inactive edge) for field 2.

† For CSL implementation, use the notation VP_VDVBLKE2_field_symval

B.24.9 Video Display Field 1 Image Offset Register (VDIMGOFF1)

The video display field 1 image offset register (VDIMGOFF1) defines the field 1 image offset and specifies the starting location of the displayed image relative to the start of the active display. The VDIMGOFF1 is shown in Figure B–327 and described in Table B–346.

The image line counter (ILCOUNT) is reset to 1 on the first image line (when FLCOUNT = VBLNKYSTOP1 + IMGVOFF1). If the NV bit is set, ILCOUNT is reset to 1 when FLCOUNT = VBLNKYSTOP1 – IMGVOFF1. Display image pixels are output in field 1 beginning on the line where ILCOUNT = 1. The default output values or blanking values are output during active lines prior to ILCOUNT = 1. For a negative offset, IMGVOFF1 must not be greater than VBLNKYSTOP1. The field 1 active image must not overlap the field 2 active image.

The image pixel counter (IPCOUNT) is reset to 0 at the start of an active line image. Once ILCOUNT = 1, image pixels from the FIFO are output on each line in field 1 beginning when FPCOUNT = IMGHOFF1. If the NH bit is set, IPCOUNT is reset when FPCOUNT = FRMWIDTH – IMGHOFF1. The default output values or blanking values are output during active pixels prior to IMGHOFF1.

Figure B–327. Video Display Field 1 Image Offset Register (VDIMGOFF1)

31	30	28	27	16
NV	Reserved	IMGVOFF1		
R/W-0	R-0	R/W-0		
15	14	12	11	0
NH	Reserved	IMGHOFF1		
R/W-0	R-0	R/W-0		

Legend: R = Read only; R/W = Read/Write; -n = value after reset

Table B–346. Video Display Field 1 Image Offset Register (VDIMGOFF1) Field Values

Bit	field [†]	symval [†]	Value	Description	
				BT.656 and Y/C Mode	Raw Data Mode
31	NV			Negative vertical image offset enable bit.	
		NONE	0		Not used.
		NEGOFF	1	Display image window begins before the first active line of field 1. (Used for VBI data output.)	Not used.
30–28	Reserved	–	0	Reserved. The reserved bit location is always read as 0. A value written to this field has no effect.	
27–16	IMGVOFF1	OF(value)	0–FFFh	Specifies the display image vertical offset in lines from the first active line of field 1.	
15	NH			Negative horizontal image offset.	
		NONE	0		Not used.
		NEGOFF	1	Display image window begins before the start of active video. (Used for HANC data output.)	Not used.
14–12	Reserved	–	0	Reserved. The reserved bit location is always read as 0. A value written to this field has no effect.	
11–0	IMGHOFF1	OF(value)	0–FFFh	Specifies the display image horizontal offset in pixels from the start of each line of active video in field 1. This must be an even number (the LSB is treated as 0).	Specifies the display image horizontal offset in pixels from the start of each line of active video in field 1.

[†] For CSL implementation, use the notation VP_VDIMGOFF1_field_symval

B.24.10 Video Display Field 1 Image Size Register (VDIMGSZ1)

The video display field 1 image size register (VDIMGSZ1) defines the field 1 image area and specifies the size of the displayed image within the active display. The VDIMGSZ1 is shown in Figure B–328 and described in Table B–347.

The image pixel counter (IPCOUNT) counts displayed image pixel output on each of the displayed image. Displayed image pixel output stops when IPCOUNT = IMGHSIZE1. The default output values or blanking values are output for the remainder of the active line.

The image line counter (ILCOUNT) counts displayed image lines. Displayed image output stops when ILCOUNT = IMGVSIZE1. The default output values or blanking values are output for the remainder of the active field.

Figure B–328. Video Display Field 1 Image Size Register (VDIMGSZ1)

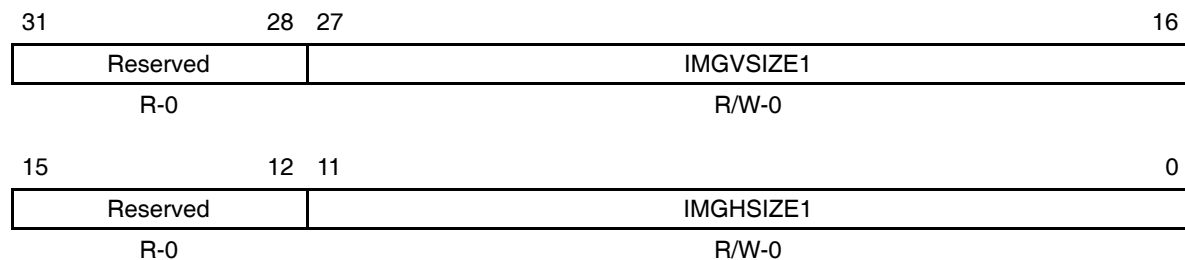

Legend: R = Read only; R/W = Read/Write; -n = value after reset

Table B–347. Video Display Field 1 Image Size Register (VDIMGSZ1) Field Values

Bit	field [†]	symval [†]	Value	Description	
				BT.656 and Y/C Mode	Raw Data Mode
31–28	Reserved	–	0	Reserved. The reserved bit location is always read as 0. A value written to this field has no effect.	
27–16	IMGVSIZE1	OF(value)	0–FFFh	Specifies the display image height in lines.	
15–12	Reserved	–	0	Reserved. The reserved bit location is always read as 0. A value written to this field has no effect.	
11–0	IMGHSIZE1	OF(value)	0–FFFh	Specifies the display image width in pixels. This number must be even (the LSB is treated as 0)	Specifies the display image width in pixels.

[†] For CSL implementation, use the notation VP_VDIMGSZ1_field_symval

B.24.11 Video Display Field 2 Image Offset Register (VDIMGOFF2)

The video display field 2 image offset register (VDIMGOFF2) defines the field 2 image offset and specifies the starting location of the displayed image relative to the start of the active display. The VDIMGOFF2 is shown in Figure B–329 and described in Table B–348.

The image line counter (ILCOUNT) is reset to 1 on the first image line (when $FLCOUNT = VBLNKYSTOP2 + IMGVOFF2$). If the NV bit is set, ILCOUNT is reset to 1 when $FLCOUNT = VBLNKYSTOP2 - IMGVOFF2$. Display image pixels are output in field 2 beginning on the line where $ILCOUNT = 1$. The default output values or blanking values are output during active lines prior to $ILCOUNT = 1$. For a negative offset, $IMGVOFF2$ must not be greater than $VBLNKYSTOP2$. The field 2 active image must not overlap the field 2 active image.

The image pixel counter (IPCOUNT) is reset to 0 at the start of an active line image. Once $ILCOUNT = 1$, image pixels from the FIFO are output on each line in field 2 beginning when $FPCOUNT = IMGHOFF2$. If the NH bit is set, IPCOUNT is reset when $FPCOUNT = FRMWIDTH - IMGHOFF2$. The default output values or blanking values are output during active pixels prior to $IMGHOFF2$.

Figure B–329. Video Display Field 2 Image Offset Register (VDIMGOFF2)

31	30	28	27	16
NV	Reserved		IMGVOFF2	
R/W-0	R-0		R/W-0	
15	14	12	11	0
NH	Reserved		IMGHOFF2	
R/W-0	R-0		R/W-0	

Legend: R = Read only; R/W = Read/Write; -n = value after reset

Table B–348. Video Display Field 2 Image Offset Register (VDIMGOFF2) Field Values

Bit	field [†]	symval [†]	Value	Description	
				BT.656 and Y/C Mode	Raw Data Mode
31	NV			Negative vertical image offset enable bit.	
		NONE	0		Not used.
		NEGOFF	1	Display image window begins before the first active line of field 2. (Used for VBI data output.)	Not used.
30–28	Reserved	–	0	Reserved. The reserved bit location is always read as 0. A value written to this field has no effect.	
27–16	IMGVOFF2	OF(value)	0–FFFh	Specifies the display image vertical offset in lines from the first active line of field 2.	
15	NH			Negative horizontal image offset.	
		NONE	0		Not used.
		NEGOFF	1	Display image window begins before the start of active video. (Used for HANC data output.)	Not used.
14–12	Reserved	–	0	Reserved. The reserved bit location is always read as 0. A value written to this field has no effect.	
11–0	IMGHOFF2	OF(value)	0–FFFh	Specifies the display image horizontal offset in pixels from the start of each line of active video in field 2. This must be an even number (the LSB is treated as 0).	Specifies the display image horizontal offset in pixels from the start of each line of active video in field 2.

[†] For CSL implementation, use the notation VP_VDIMGOFF2_field_symval

B.24.12 Video Display Field 2 Image Size Register (VDIMGSZ2)

The video display field 2 image size register (VDIMGSZ2) defines the field 2 image area and specifies the size of the displayed image within the active display. The VDIMGSZ2 is shown in Figure B–330 and described in Table B–349.

The image pixel counter (IPCOUNT) counts displayed image pixel output on each of the displayed image. Displayed image pixel output stops when IPCOUNT = IMGHSIZE2. The default output values or blanking values are output for the remainder of the active line.

The image line counter (ILCOUNT) counts displayed image lines. Displayed image output stops when ILCOUNT = IMGVSIZE2. The default output values or blanking values are output for the remainder of the active field.

Figure B–330. Video Display Field 2 Image Size Register (VDIMGSZ2)

31	28	27	16
Reserved		IMGVSIZE2	
R-0		R/W-0	
15	12	11	0
Reserved		IMGHSIZE2	
R-0		R/W-0	

Legend: R = Read only; R/W = Read/Write; -n = value after reset

Table B–349. Video Display Field 2 Image Size Register (VDIMGSZ2) Field Values

Bit	field†	symval†	Value	Description	
				BT.656 and Y/C Mode	Raw Data Mode
31–28	Reserved	–	0	Reserved. The reserved bit location is always read as 0. A value written to this field has no effect.	
27–16	IMGVSIZE2	OF(value)	0–FFFh	Specifies the display image height in lines.	
15–12	Reserved	–	0	Reserved. The reserved bit location is always read as 0. A value written to this field has no effect.	
11–0	IMGHSIZE2	OF(value)	0–FFFh	Specifies the display image width in pixels. This number must be even (the LSB is treated as 0)	Specifies the display image width in pixels.

† For CSL implementation, use the notation VP_VDIMGSZ2_field_symval

B.24.13 Video Display Field 1 Timing Register (VDFLDT1)

The video display field 1 timing register (VDFLDT1) sets the timing of the field identification signal. The VDFLDT1 is shown in Figure B–331 and described in Table B–350.

In raw data mode, the FLD signal is deasserted to indicate field 1 display whenever the frame line counter (FLCOUNT) is equal to FLD1YSTART and the frame pixel counter (FPCOUNT) is equal to FLD1XSTART.

In BT.656 and Y/C mode, the FLD signal is deasserted to indicate field 1 display whenever $FLCOUNT = FLD1YSTART$ and $FPCOUNT = FLD1XSTART$. The FLD output is completely independent of the timing control codes. The F bit in the EAV/SAV codes is controlled by the VDFBIT register.

Figure B–331. Video Display Field 1 Timing Register (VDFLDT1)

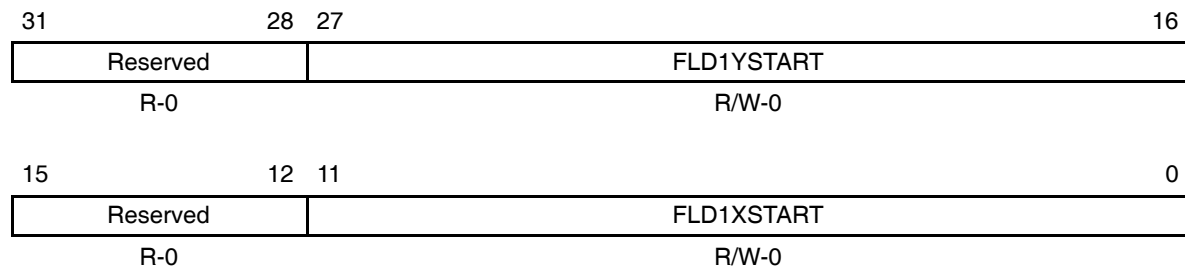

Legend: R = Read only; R/W = Read/Write; -n = value after reset

Table B–350. Video Display Field 1 Timing Register (VDFLDT1) Field Values

Bit	field [†]	symval [†]	Value	Description
31–28	Reserved	–	0	Reserved. The reserved bit location is always read as 0. A value written to this field has no effect.
27–16	FLD1YSTART	OF(value)	0–FFFh	Specifies the first line of field 1. (The line where FLD is deasserted.)
15–12	Reserved	–	0	Reserved. The reserved bit location is always read as 0. A value written to this field has no effect.
11–0	FLD1XSTART	OF(value)	0–FFFh	Specifies the pixel on the first line of field 1 where the FLD output is deasserted.

[†] For CSL implementation, use the notation VP_VDFLDT1_field_symval

B.24.14 Video Display Field 2 Timing Register (VDFLDT2)

The video display field 2 timing register (VDFLDT2) sets the timing of the field identification signal. The VDFLDT2 is shown in Figure B–332 and described in Table B–351.

In raw data mode, the FLD signal is asserted whenever the frame line counter (FLCOUNT) is equal to FLD2YSTART and the frame pixel counter (FPCOUNT) is equal to FLD2XSTART.

In BT.656 and Y/C mode, the FLD signal is asserted to indicate field 2 display whenever FLCOUNT = FLD2YSTART and FPCOUNT = FLD2XSTART. The FLD output is completely independent of the timing control codes. The F bit in the EAV/SAV codes is controlled by the VDFBIT register.

Figure B–332. Video Display Field 2 Timing Register (VDFLDT2)

31	28	27	16
Reserved		FLD2YSTART	
R-0		R/W-0	
15	12	11	0
Reserved		FLD2XSTART	
R-0		R/W-0	

Legend: R = Read only; R/W = Read/Write; -n = value after reset

Table B–351. Video Display Field 2 Timing Register (VDFLDT2) Field Values

Bit	field [†]	symval [†]	Value	Description
31–28	Reserved	–	0	Reserved. The reserved bit location is always read as 0. A value written to this field has no effect.
27–16	FLD2YSTART	OF(value)	0–FFFh	Specifies the first line of field 2. (The line where FLD is asserted.)
15–12	Reserved	–	0	Reserved. The reserved bit location is always read as 0. A value written to this field has no effect.
11–0	FLD2XSTART	OF(value)	0–FFFh	Specifies the pixel on the first line of field 2 where the FLD output is asserted.

[†] For CSL implementation, use the notation VP_VDFLDT2_field_symval

B.24.15 Video Display Threshold Register (VDTHRLD)

The video display threshold register (VDTHRLD) sets the display FIFO threshold to determine when to load more display data. The VDTHRLD is shown in Figure B–333 and described in Table B–352.

The VDTHRLD n bits determines how much space must be available in the display FIFOs before the appropriate DMA event may be generated. The Y FIFO uses the VDTHRLD n value directly while the Cb and Cr values use $\frac{1}{2}$ the VDTHRLD n value rounded up to the next doubleword ($\frac{1}{2}(\text{VDTHRLD}_n + \text{VTHRLD}_n \bmod 2)$). The DMA transfer size must be less than the value used for each FIFO. Typically, VDTHRLD n is set to the horizontal line length rounded up to the next doubleword boundary. For nonline length thresholds, the display data unpacking mechanism places certain restrictions of what VDTHRLD n values are valid.

The VDTHRLD2 bits behaves identically to VDTHRLD1, but are used during field 2 capture. It is only used if the field 2 DMA size needs to be different from the field 1 DMA size for some reason (for example, different display line lengths in field 1 and field 2).

In raw display mode, the INCPIX bits determine when the frame pixel counter (FPCOUNT) is incremented . If, for example, each output value represents the R, G, or B portion of a display pixel, then the INCPIX bits are set to 3h so that the pixel counter is incremented only on every third output clock. An INCPIX value of 0h represents a count of 16 rather than 0.

Figure B–333. Video Display Threshold Register (VDTHRLD)

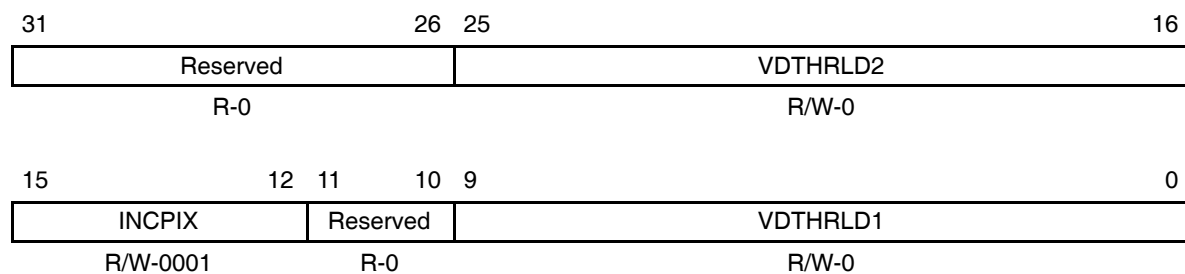

Legend: R = Read only; R/W = Read/Write; -n = value after reset

Table B–352. Video Display Threshold Register (VDTHRLD) Field Values

Bit	field [†]	symval [†]	Value	Description	
				BT.656 and Y/C Mode	Raw Data Mode
31–26	Reserved	–	0	Reserved. The reserved bit location is always read as 0. A value written to this field has no effect.	
25–16	VDTHRLD2	OF(<i>value</i>)	0–3FFh	Field 2 threshold. Whenever there are at least VDTHRLD doublewords of space in the Y display FIFO, a new Y DMA event may be generated. Whenever there are at least ½ VDTHRLD doublewords of space in the Cb or Cr display FIFO, a new Cb or Cr DMA event may be generated.	Field 2 threshold. Whenever there are at least VDTHRLD doublewords of space in the display FIFO, a new Y DMA event may be generated.
15–12	INCPIX	OF(<i>value</i>)	0–Fh	Not used.	FPCOUNT is incremented every INCPIX output clocks.
11–10	Reserved	–	0	Reserved. The reserved bit location is always read as 0. A value written to this field has no effect.	
9–0	VDTHRLD1	OF(<i>value</i>)	0–3FFh	Field 1 threshold. Whenever there are at least VDTHRLD doublewords of space in the Y display FIFO, a new Y DMA event may be generated. Whenever there are at least ½ VDTHRLD doublewords of space in the Cb or Cr display FIFO, a new Cb or Cr DMA event may be generated.	Field 1 threshold. Whenever there are at least VDTHRLD doublewords of space in the display FIFO, a new Y DMA event may be generated.

[†] For CSL implementation, use the notation VP_VDTHRLD_*field_symval*

B.24.16 Video Display Horizontal Synchronization Register (VDHSYNC)

The video display horizontal synchronization register (VDHSYNC) controls the timing of the horizontal synchronization signal. The VDHSYNC is shown in Figure B–334 and described in Table B–353.

The HSYNC signal is asserted to indicate the start of the horizontal sync pulse whenever the frame pixel counter (FPCOUNT) is equal to HSYNCSTART. The HSYNC signal is deasserted to indicate the end of the horizontal sync pulse whenever FPCOUNT = HSYNCSTOP.

Figure B–334. Video Display Horizontal Synchronization Register (VDHSYNC)

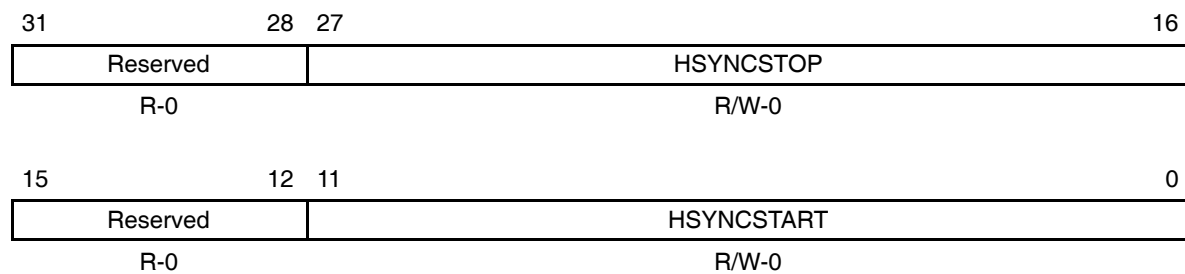

Legend: R = Read only; R/W = Read/Write; -n = value after reset

Table B–353. Video Display Horizontal Synchronization Register (VDHSYNC) Field Values

Bit	field [†]	symval [†]	Value	Description
31–28	Reserved	–	0	Reserved. The reserved bit location is always read as 0. A value written to this field has no effect.
27–16	HSYNCSTOP	OF(value)	0–FFFh	Specifies the pixel where HSYNC is deasserted.
15–12	Reserved	–	0	Reserved. The reserved bit location is always read as 0. A value written to this field has no effect.
11–0	HSYNCSTART	OF(value)	0–FFFh	Specifies the pixel where HSYNC is asserted.

[†] For CSL implementation, use the notation VP_VDHSYNC_field_symval

B.24.17 Video Display Field 1 Vertical Synchronization Start Register (VDVSYNS1)

The video display field 1 vertical synchronization start register (VDVSYNS1) controls the start of vertical synchronization in field 1. The VDVSYNS1 is shown in Figure B–335 and described in Table B–354.

The VSYNC signal is asserted whenever the frame line counter (FLCOUNT) is equal to VSYNCYSTART1 and the frame pixel counter (FPCOUNT) is equal to VSYNCXSTART1.

Figure B–335. Video Display Field 1 Vertical Synchronization Start Register (VDVSYNS1)

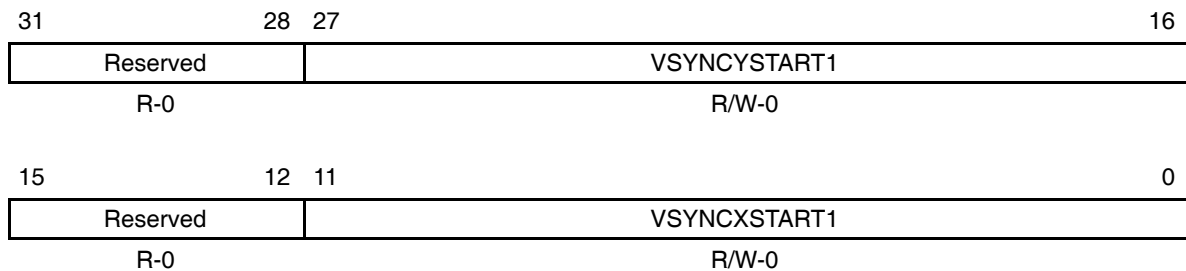

Legend: R = Read only; R/W = Read/Write; -n = value after reset

Table B–354. Video Display Field 1 Vertical Synchronization Start Register (VDVSYNS1) Field Values

Bit	field [†]	symval [†]	Value	Description
31–28	Reserved	–	0	Reserved. The reserved bit location is always read as 0. A value written to this field has no effect.
27–16	VSYNCYSTART1	OF(value)	0–FFFh	Specifies the line where VSYNC is asserted for field 1.
15–12	Reserved	–	0	Reserved. The reserved bit location is always read as 0. A value written to this field has no effect.
11–0	VSYNCXSTART1	OF(value)	0–FFFh	Specifies the pixel where VSYNC is asserted in field 1.

[†] For CSL implementation, use the notation VP_VDVSYNS1_field_symval

B.24.18 Video Display Field 1 Vertical Synchronization End Register (VDVSYNE1)

The video display field 1 vertical synchronization end register (VDVSYNE1) controls the end of vertical synchronization in field 1. The VDVSYNE1 is shown in Figure B–336 and described in Table B–355.

The VSYNC signal is deasserted whenever the frame line counter (FLCOUNT) is equal to VSYNCYSTOP1 and the frame pixel counter (FPCOUNT) is equal to VSYNCXSTOP1.

Figure B–336. Video Display Field 1 Vertical Synchronization End Register (VDVSYNE1)

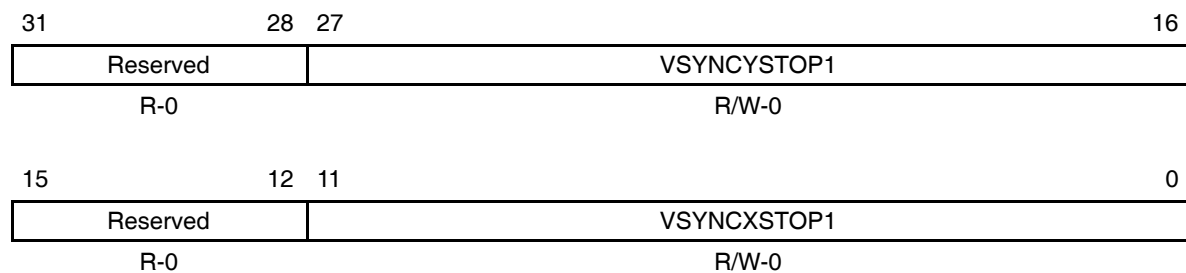

Legend: R = Read only; R/W = Read/Write; -n = value after reset

Table B–355. Video Display Field 1 Vertical Synchronization End Register (VDVSYNE1) Field Values

Bit	field [†]	symval [†]	Value	Description
31–28	Reserved	–	0	Reserved. The reserved bit location is always read as 0. A value written to this field has no effect.
27–16	VSYNCYSTOP1	OF(value)	0–FFFh	Specifies the line where VSYNC is deasserted for field 1.
15–12	Reserved	–	0	Reserved. The reserved bit location is always read as 0. A value written to this field has no effect.
11–0	VSYNCXSTOP1	OF(value)	0–FFFh	Specifies the pixel where VSYNC is deasserted in field 1.

[†] For CSL implementation, use the notation VP_VDVSYNE1_field_symval

B.24.19 Video Display Field 2 Vertical Synchronization Start Register (VDVSYNS2)

The video display field 2 vertical synchronization start register (VDVSYNS2) controls the start of vertical synchronization in field 2. The VDVSYNS2 is shown in Figure B–337 and described in Table B–356.

The VSYNC signal is asserted whenever the frame line counter (FLCOUNT) is equal to VSYNCYSTART2 and the frame pixel counter (FPCOUNT) is equal to VSYNCXSTART2.

Figure B–337. Video Display Field 2 Vertical Synchronization Start Register (VDVSYNS2)

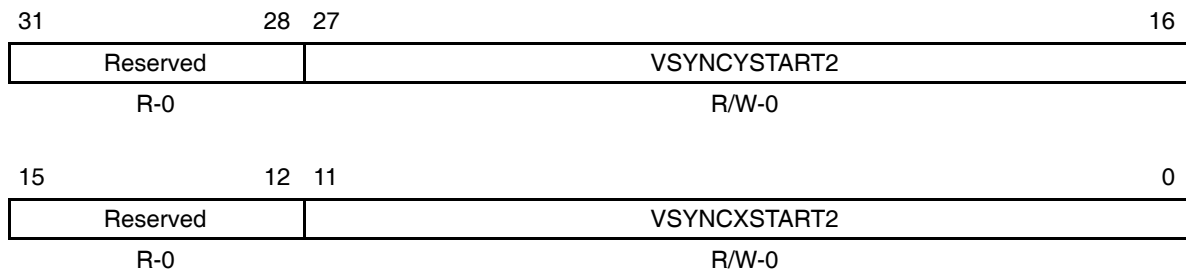

Legend: R = Read only; R/W = Read/Write; -n = value after reset

Table B–356. Video Display Field 2 Vertical Synchronization Start Register (VDVSYNS2) Field Values

Bit	field [†]	symval [†]	Value	Description
31–28	Reserved	–	0	Reserved. The reserved bit location is always read as 0. A value written to this field has no effect.
27–16	VSYNCYSTART2	OF(value)	0–FFFh	Specifies the line where VSYNC is asserted for field 2.
15–12	Reserved	–	0	Reserved. The reserved bit location is always read as 0. A value written to this field has no effect.
11–0	VSYNCXSTART2	OF(value)	0–FFFh	Specifies the pixel where VSYNC is asserted in field 2.

[†] For CSL implementation, use the notation VP_VDVSYNS2_field_symval

B.24.20 Video Display Field 2 Vertical Synchronization End Register (VDVSYNE2)

The video display field 2 vertical synchronization end register (VDVSYNE2) controls the end of vertical synchronization in field 2. The VDVSYNE2 is shown in Figure B–338 and described in Table B–357.

The VSYNC signal is deasserted whenever the frame line counter (FLCOUNT) is equal to VSYNCYSTOP2 and the frame pixel counter (FPCOUNT) is equal to VSYNCXSTOP2.

Figure B–338. Video Display Field 2 Vertical Synchronization End Register (VDVSYNE2)

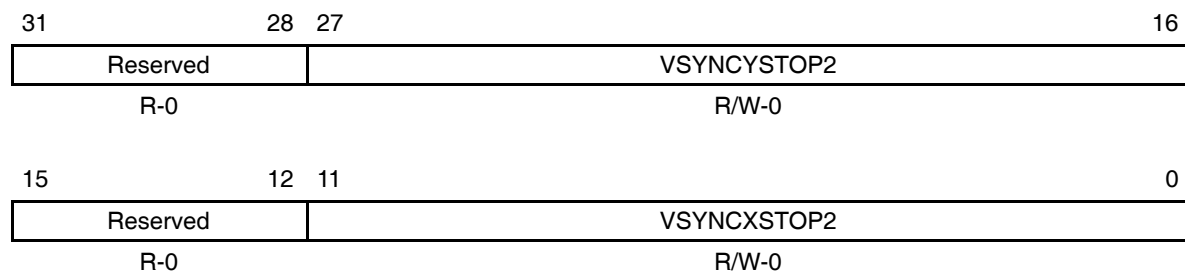

Legend: R = Read only; R/W = Read/Write; -n = value after reset

Table B–357. Video Display Field 2 Vertical Synchronization End Register (VDVSYNE2) Field Values

Bit	field [†]	symval [†]	Value	Description
31–28	Reserved	–	0	Reserved. The reserved bit location is always read as 0. A value written to this field has no effect.
27–16	VSYNCYSTOP2	OF(value)	0–FFFh	Specifies the line where VSYNC is deasserted for field 2.
15–12	Reserved	–	0	Reserved. The reserved bit location is always read as 0. A value written to this field has no effect.
11–0	VSYNCXSTOP2	OF(value)	0–FFFh	Specifies the pixel where VSYNC is deasserted in field 2.

[†] For CSL implementation, use the notation VP_VDVSYNE2_field_symval

B.24.21 Video Display Counter Reload Register (VDRELOAD)

When external horizontal or vertical synchronization are used, the video display counter reload register (VDRELOAD) determines what values are loaded into the counters when an external sync is activated. The VDRELOAD is shown in Figure B–339 and described in Table B–358.

Figure B–339. Video Display Counter Reload Register (VDRELOAD)

31	28	27	16
Reserved		VRLD	
R-0		R/W-0	
15	12	11	0
CRLD		HRLD	
R/W-0		R/W-0	

Legend: R = Read only; R/W = Read/Write; -n = value after reset

Table B–358. Video Display Counter Reload Register (VDRELOAD) Field Values

Bit	field [†]	symval [†]	Value	Description
31–28	Reserved	–	0	Reserved. The reserved bit location is always read as 0. A value written to this field has no effect.
27–16	VRLD	OF(value)	0–FFFh	Value loaded into frame line counter (FLCOUNT) when external VSYNC occurs.
15–12	CRLD	OF(value)	0–Fh	Value loaded into video clock counter (VCCOUNT) when external HSYNC occurs.
11–0	HRLD	OF(value)	0–FFFh	Value loaded into frame pixel counter (FPCOUNT) when external HSYNC occurs.

[†] For CSL implementation, use the notation VP_VDRELOAD_field_symval

B.24.22 Video Display Display Event Register (VDDISPEVT)

The video display display event register (VDDISPEVT) is programmed with the number of DMA events to be generated for display field 1 and field 2. The VDDISPEVT is shown in Figure B–340 and described in Table B–359.

Figure B–340. Video Display Display Event Register (VDDISPEVT)

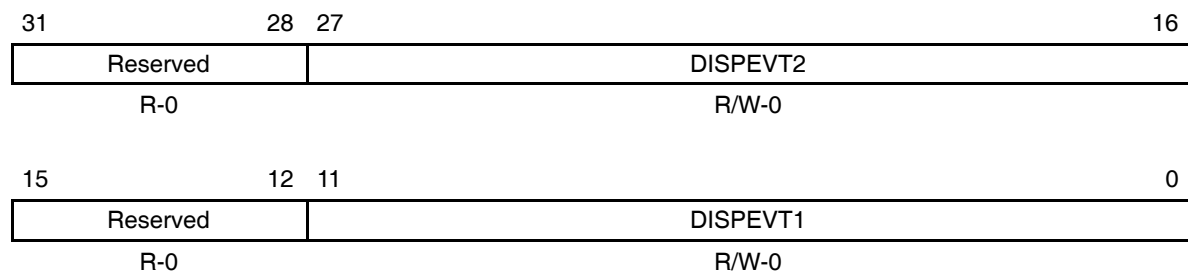

Legend: R = Read only; R/W = Read/Write; -n = value after reset

Table B–359. Video Display Display Event Register (VDDISPEVT) Field Values

Bit	field [†]	symval [†]	Value	Description	
				BT.656 and Y/C Mode	Raw Data Mode
31–28	Reserved	–	0	Reserved. The reserved bit location is always read as 0. A value written to this field has no effect.	
27–16	DISPEVT2	OF(value)	0–FFFh	Specifies the number of DMA event sets (YEVT, CbEVT, CrEVT) to be generated for field 2 output.	Specifies the number of DMA events (YEVT) to be generated for field 2 output.
15–12	Reserved	–	0	Reserved. The reserved bit location is always read as 0. A value written to this field has no effect.	
11–0	DISPEVT1	OF(value)	0–FFFh	Specifies the number of DMA event sets (YEVT, CbEVT, CrEVT) to be generated for field 1 output.	Specifies the number of DMA events (YEVT) to be generated for field 1 output.

[†] For CSL implementation, use the notation VP_VDDISPEVT_DISPEVTn_symval

B.24.23 Video Display Clipping Register (VDCLIP)

The video display clipping register (VDCLIP) is shown in Figure B–341 and described in Table B–360.

The video display module in the BT.656 and Y/C modes performs programmable clipping. The clipping is performed as the last step of the video pipeline. It is applied only on the image areas defined by VDIMGSZ n and VDIMGOFF n inside the active video area (blanking values are not clipped).

VDCLIP allows output values to be clamped within the specified values. The default values are the BT.601-specified peak black level of 16 and peak white level of 235 for luma and the maximum quantization levels of 16 and 240 for chroma. For 10-bit operation, the clipping is applied to the 8 MSBs of the value with the 2 LSBs cleared. (For example, a Y value of FF.8h is clipped to EB.0h and a Y value of 0F.4h is clipped to 10.0h.)

Figure B–341. Video Display Clipping Register (VDCLIP)

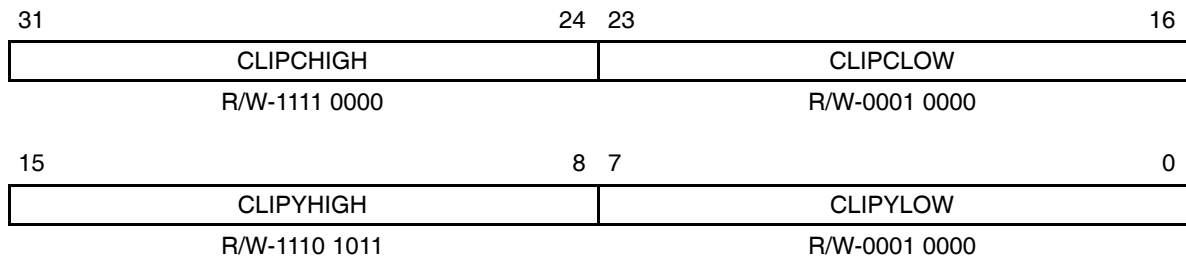

Legend: R/W = Read/Write; - n = value after reset

Table B–360. Video Display Clipping Register (VDCLIP) Field Values

Bit	field [†]	symval [†]	Value	Description	
				BT.656 and Y/C Mode	Raw Data Mode
31–24	CLIPCHIGH	OF(<i>value</i>)	0–FFh	A Cb or Cr value greater than CLIPCHIGH is forced to the CLIPCHIGH value.	Not used.
23–16	CLIPCLOW	OF(<i>value</i>)	0–FFh	A Cb or Cr value less than CLIPCLOW is forced to the CLIPCLOW value.	Not used.
15–8	CLIPYHIGH	OF(<i>value</i>)	0–FFh	A Y value greater than CLIPYHIGH is forced to the CLIPYHIGH value.	Not used.
7–0	CLIPYLOW	OF(<i>value</i>)	0–FFh	A Y value less than CLIPYLOW is forced to the CLIPYLOW value.	Not used.

[†] For CSL implementation, use the notation VP_VDCLIP_*field_symval*

B.24.24 Video Display Default Display Value Register (VDDEFVAL)

The video display default display value register (VDDEFVAL) defines the default value to be output during the portion of the active video window that is not part of the displayed image. The VDDEFVAL is shown in Figure B–342 for the BT.656 and Y/C modes and in Figure B–343 for the raw data mode, and described in Table B–361.

The default value is output during the nonimage display window portions of the active video. This is the region between $ILCOUNT = 0$ and $ILCOUNT = IMGVOFFn$ vertically, and between $IPCOUNT = 0$ and $IPCOUNT = IMGHOFFn$ horizontally. In BT.656 mode, CBDEFVAL, YDEFVAL, and CRDEFVAL are multiplexed on the output in the standard CbYCrY manner. In Y/C mode, YDEFVAL is output on the VDOUT[9–0] bus and CBDEFVAL and CRDEFVAL are multiplexed on the VDOUT[19–10] bus. In all cases, the default values are output on the 8 MSBs of the bus ([9–2] or [19–12]) and the 2 LSBs ([1–0] or [11–10]) are driven as 0s.

In raw data mode, the least significant 8, 10, 16, or 20 bits of DEFVAL are output depending on the bus width. The default value is also output during the horizontal and vertical blanking periods in raw data mode.

The default value is also output during the entire active video region when the BLKDIS bit in VDCTL is set and the FIFO is empty.

Figure B–342. Video Display Default Display Value Register (VDDEFVAL)

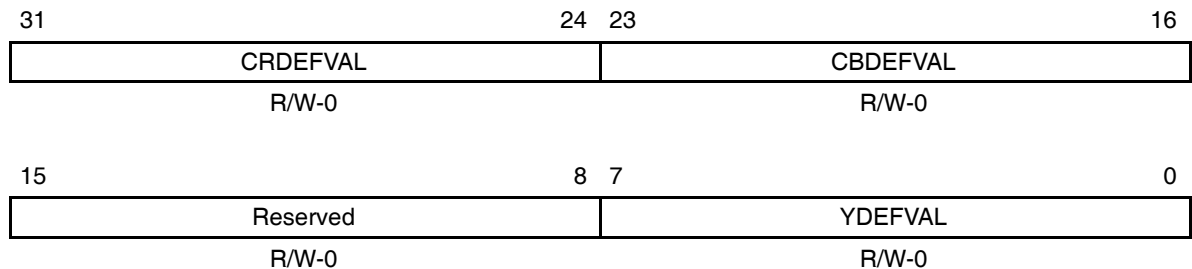

Legend: R/W = Read/Write; -n = value after reset

Figure B–343. Video Display Default Display Value Register (VDDEFVAL)—Raw Data Mode

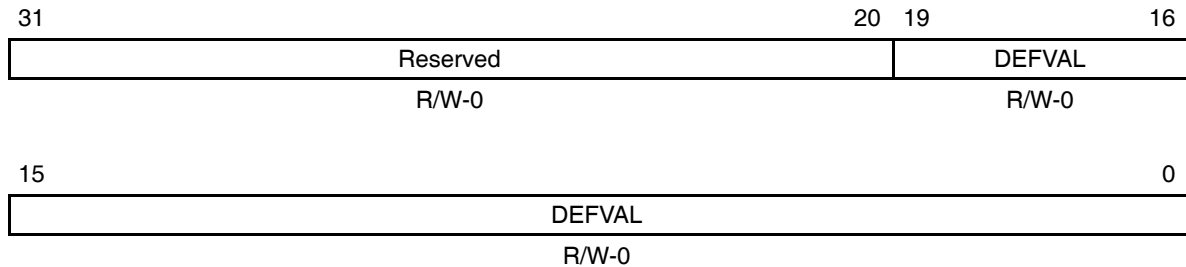

Legend: R/W = Read/Write; -n = value after reset

Table B–361. Video Display Default Display Value Register (VDDEFVAL) Field Values

Bit	field [†]	symval [†]	Value	Description	
				BT.656 and Y/C Mode	Raw Data Mode
31–24	CRDEFVAL	OF(<i>value</i>)	0–FFh	Specifies the 8 MSBs of the default Cr display value.	Not used.
31–20 [‡]	Reserved	–	0	Not used.	Reserved. The reserved bit location is always read as 0. A value written to this field has no effect.
19–0 [‡]	DEFVAL	OF(<i>value</i>)	0–FFFFFFh	Not used.	Specifies the default raw data display value.
23–16	CBDEFVAL	OF(<i>value</i>)	0–FFh	Specifies the 8 MSBs of the default Cb display value.	Not used.
15–8	Reserved	–	0	Reserved. The reserved bit location is always read as 0. A value written to this field has no effect.	Not used.
7–0	YDEFVAL	OF(<i>value</i>)	0–FFh	Specifies the 8 MSBs of the default Y display value.	Not used.

[†] For CSL implementation, use the notation VP_VDDEFVAL_*field_symval*

[‡] Raw data mode only.

B.24.25 Video Display Vertical Interrupt Register (VDVINT)

The video display vertical interrupt register (VDVINT) controls the generation of vertical interrupts in field 1 and field 2. The VDVINT is shown in Figure B–344 and described in Table B–362.

An interrupt can be generated upon completion of the specified line in a field (when $FLCOUNT = VINTn$). This allows the software to synchronize itself to the frame or field. The interrupt can be programmed to occur in one, both, or no fields using the VIF1 and VIF2 bits.

Figure B–344. Video Display Vertical Interrupt Register (VDVINT)

31	30	28	27	16
VIF2	Reserved			VINT2
R/W-0	R-0			R/W-0
15	14	12	11	0
VIF1	Reserved			VINT1
R/W-0	R-0			R/W-0

Legend: R = Read only; R/W = Read/Write; -n = value after reset

Table B–362. Video Display Vertical Interrupt Register (VDVINT) Field Values

Bit	field [†]	symval [†]	Value	Description
31	VIF2			Vertical interrupt (VINT) in field 2 enable bit.
		DISABLE	0	Vertical interrupt (VINT) in field 2 is disabled.
		ENABLE	1	Vertical interrupt (VINT) in field 2 is enabled.
30–28	Reserved	–	0	Reserved. The reserved bit location is always read as 0. A value written to this field has no effect.
27–16	VINT2	OF(value)	0–FFFh	Line where vertical interrupt (VINT) occurs, if VIF2 bit is set.
15	VIF1			Vertical interrupt (VINT) in field 1 enable bit.
		DISABLE	0	Vertical interrupt (VINT) in field 1 is disabled.
		ENABLE	1	Vertical interrupt (VINT) in field 1 is enabled.
14–12	Reserved	–	0	Reserved. The reserved bit location is always read as 0. A value written to this field has no effect.
11–0	VINT1	OF(value)	0–FFFh	Line where vertical interrupt (VINT) occurs, if VIF1 bit is set.

[†] For CSL implementation, use the notation `VP_VDVINT_field_symval`

B.24.26 Video Display Field Bit Register (VDFBIT)

The video display field bit register (VDFBIT) controls the F bit value in the EAV and SAV timing control codes. The VDFBIT is shown in Figure B–345 and described in Table B–363.

The FBITCLR and FBITSET bits control the F bit value in the EAV and SAV timing control codes. The F bit is cleared to 0 (indicating field 1 display) in the EAV code at the beginning of the line whenever the frame line counter (FLCOUNT) is equal to FBITCLR. It remains a 0 for all subsequent EAV/SAV codes until the EAV at the beginning of the line when $FLCOUNT = FBITSET$ where it changes to 1 (indicating field 2 display). The F bit operation is completely independent of the FLD control signal.

For interlaced operation, FBITCLR and FBITSET are typically programmed such that the F bit changes coincidentally with or some time after the V bit transitions from 1 to 0 (as determined by VBITCLR1 and VBITCLR2 in VDVBIT n). For progressive scan operation no field 2 output occurs, so FBITSET should be programmed to a value greater than FRMHEIGHT so that the condition $FLCOUNT = FBITSET$ never occurs and the F bit is always 0.

Figure B–345. Video Display Field Bit Register (VDFBIT)

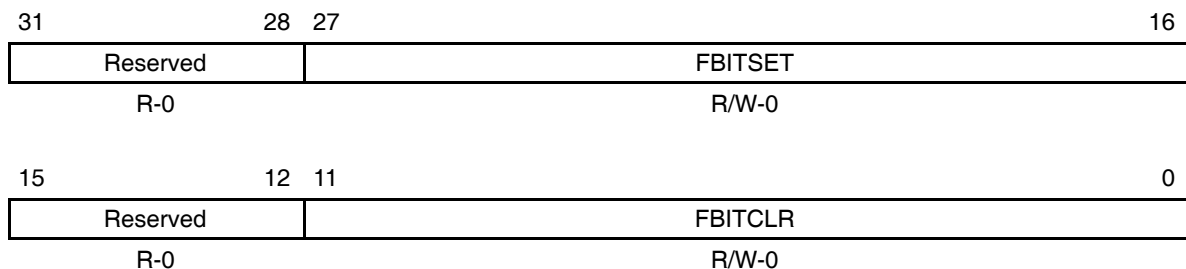

Legend: R = Read only; R/W = Read/Write; -n = value after reset

Table B–363. Video Display Field Bit Register (VDFBIT) Field Values

Bit	field [†]	symval [†]	Value	Description	
				BT.656 and Y/C Mode	Raw Data Mode
31–28	Reserved	–	0	Reserved. The reserved bit location is always read as 0. A value written to this field has no effect.	
27–16	FBITSET	OF(value)	0–FFFh	Specifies the first line with an EAV of F = 1 indicating field 2 display.	Not used.
15–12	Reserved	–	0	Reserved. The reserved bit location is always read as 0. A value written to this field has no effect.	
11–0	FBITCLR	OF(value)	0–FFFh	Specifies the first line with an EAV of F = 0 indicating field 1 display.	Not used.

[†] For CSL implementation, use the notation VP_VDFBIT_field_symval

B.24.27 Video Display Field 1 Vertical Blanking Bit Register (VDVBIT1)

The video display field 1 vertical blanking bit register (VDVBIT1) controls the V bit value in the EAV and SAV timing control codes for field 1. The VDVBIT1 is shown in Figure B–346 and described in Table B–364.

The VBITSET1 and VBITCLR1 bits control the V bit value in the EAV and SAV timing control codes. The V bit is set to 1 (indicating the start of field 1 digital vertical blanking) in the EAV code at the beginning of the line whenever the frame line counter (FLCOUNT) is equal to VBITSET1. It remains a 1 for all EAV/SAV codes until the EAV at the beginning of the line on when FLCOUNT = VBITCLR1 where it changes to 0 (indicating the start of the field 1 digital active display). The V bit operation is completely independent of the VBLNK control signal.

The VBITSET1 and VBITCLR1 bits should be programmed so that FLCOUNT becomes set to 1 during field 1 vertical blanking. The hardware only starts generating field 1 EDMA events when FLCOUNT = 1.

Figure B–346. Video Display Field 1 Vertical Blanking Bit Register (VDVBIT1)

31	28	27	16
Reserved		VBITCLR1	
R-0		R/W-0	
15	12	11	0
Reserved		VBITSET1	
R-0		R/W-0	

Legend: R = Read only; R/W = Read/Write; -n = value after reset

Table B–364. Video Display Field 1 Vertical Blanking Bit Register (VDVBIT1) Field Values

Bit	field [†]	symval [†]	Value	Description	
				BT.656 and Y/C Mode	Raw Data Mode
31–28	Reserved	–	0	Reserved. The reserved bit location is always read as 0. A value written to this field has no effect.	
27–16	VBITCLR1	OF(value)	0–FFFh	Specifies the first line with an EAV of V = 0 indicating the start of field 1 active display.	Not used.
15–12	Reserved	–	0	Reserved. The reserved bit location is always read as 0. A value written to this field has no effect.	
11–0	VBITSET1	OF(value)	0–FFFh	Specifies the first line with an EAV of V = 1 indicating the start of field 1 vertical blanking.	Not used.

[†] For CSL implementation, use the notation VP_VDVBIT1_field_symval

B.24.28 Video Display Field 2 Vertical Blanking Bit Register (VDVBIT2)

The video display field 2 vertical blanking bit register (VDVBIT2) controls the V bit in the EAV and SAV timing control words for field 2. The VDVBIT2 is shown in Figure B–347 and described in Table B–365.

The VBITSET2 and VBITCLR2 bits control the V bit value in the EAV and SAV timing control codes. The V bit is set to 1 (indicating the start of field 2 digital vertical blanking) in the EAV code at the beginning of the line whenever the frame line counter (FLCOUNT) is equal to VBITSET2. It remains a 1 for all EAV/SAV codes until the EAV at the beginning of the line on when FLCOUNT = VBITCLR2 where it changes to 0 (indicating the start of the field 2 digital active display). The V bit operation is completely independent of the VBLNK control signal.

For correct interlaced operation, the region defined by VBITSET2 and VBITCLR2 must not overlap the region defined by VBITSET1 and VBITCLR1. For progressive scan operation, VBITSET2 and VBITCLR2 should be programmed to a value greater than FRMHEIGHT.

Figure B–347. Video Display Field 2 Vertical Blanking Bit Register (VDVBIT2)

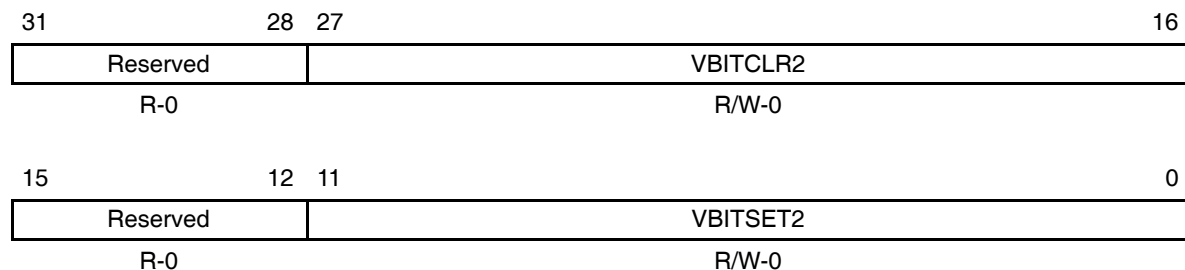

Legend: R = Read only; R/W = Read/Write; -n = value after reset

Table B–365. Video Display Field 2 Vertical Blanking Bit Register (VDVBIT2) Field Values

Bit	field [†]	symval [†]	Value	Description	
				BT.656 and Y/C Mode	Raw Data Mode
31–28	Reserved	–	0	Reserved. The reserved bit location is always read as 0. A value written to this field has no effect.	
27–16	VBITCLR2	OF(<i>value</i>)	0–FFFh	Specifies the first line with an EAV of V = 0 indicating the start of field 2 active display.	Not used.
15–12	Reserved	–	0	Reserved. The reserved bit location is always read as 0. A value written to this field has no effect.	
11–0	VBITSET2	OF(<i>value</i>)	0–FFFh	Specifies the first line with an EAV of V = 1 indicating the start of field 2 vertical blanking.	Not used.

[†] For CSL implementation, use the notation VP_VDVBIT2_*field_symval*

B.25 Video Port GPIO Registers

The GPIO register set includes required registers such as peripheral identification and emulation control. The GPIO registers are listed in Table B–366. See the device-specific datasheet for the memory address of these registers.

Table B–366. Video Port GPIO Registers

Offset Address [†]	Acronym	Register Name	Section
00h	VPPID	Video Port Peripheral Identification Register	B.25.1
04h	PCR	Video Port Power Management Register	B.25.2
20h	PFUNC	Video Port Pin Function Register	B.25.3
24h	PDIR	Video Port GPIO Direction Control Register 0	B.25.5
28h	PDIN	Video Port GPIO Data Input Register	B.25.6
2Ch	PDOUT	Video Port GPIO Data Output Register	B.25.7
30h	PDSET	Video Port GPIO Data Set Register	B.25.8
34h	PDCLR	Video Port GPIO Data Clear Register	B.25.8
38h	PIEN	Video Port GPIO Interrupt Enable Register	B.25.9
3Ch	PIPOL	Video Port GPIO Interrupt Polarity Register	B.25.10
40h	PISTAT	Video Port GPIO Interrupt Status Register	B.25.11
44h	PICLR	Video Port GPIO Interrupt Clear Register	B.25.12

[†] The absolute address of the registers is device/port specific and is equal to the base address + offset address. See the device-specific datasheet to verify the register addresses.

B.25.1 Video Port Peripheral Identification Register (VPPID)

The video port peripheral identification register (VPPID) is a read-only register used to store information about the peripheral. The VPPID is shown in Figure B–348 and described in Table B–367.

Figure B–348. Video Port Peripheral Identification Register (VPPID)

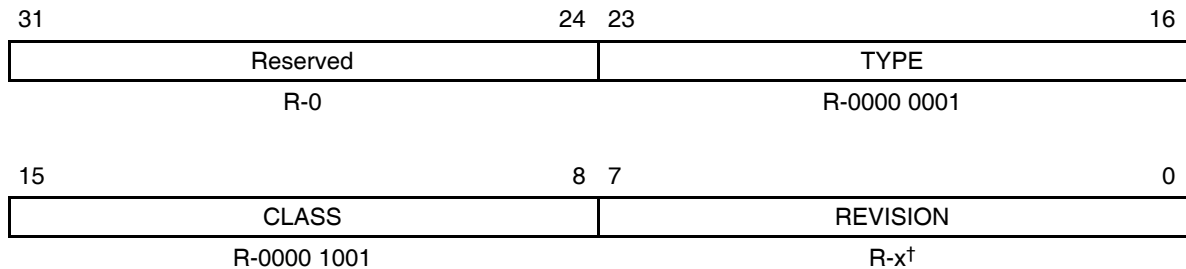

Legend: R = Read only; -n = value after reset

† See the device-specific datasheet for the default value of this field.

Table B–367. Video Port Peripheral Identification Register (VPPID) Field Values

Bit	field†	symval†	Value	Description
31–24	Reserved	–	0	Reserved. The reserved bit location is always read as 0. A value written to this field has no effect.
23–16	TYPE			Identifies type of peripheral.
		OF(value)	01h	Video port.
15–8	CLASS			Identifies class of peripheral.
		OF(value)	09h	Video
7–0	REVISION			Identifies revision of peripheral.
		OF(value)	x	See the device-specific datasheet for the value.

† For CSL implementation, use the notation VP_VPPID_field_symval

B.25.2 Video Port Peripheral Control Register (PCR)

The video port peripheral control register (PCR) determines operation during emulation. The video port peripheral control register is shown in Figure B–349 and described in Table B–368.

Normal operation is to not halt the port during emulation suspend. This allows a displayed image to remain visible during suspend. However, this will only work if one of the continuous capture/display modes is selected because non-continuous modes require CPU intervention for DMAs to continue indefinitely (and the CPU is halted during emulation suspend).

When FREE = 0, emulation suspend can occur. Clocks and counters continue to run in order to maintain synchronization with external devices. The video port waits until a field boundary to halt DMA event generation, so that upon restart the video port can begin generating events again at the precise point it left off. After exiting suspend, the video port waits for the correct field boundary to occur and then reenables DMA events. The DMA pointers will be at the correct location for capture/display to resume where it left off. The emulation suspend operation is similar to the BLKCAP or BLKDISP operation with the difference being that BLKCAP and BLKDISP operations take effect immediately rather than at field completion and rely on you to reset the DMA mechanism before they are cleared.

There is no separate emulation suspend mechanism on the video capture side. The field and frame operation can be used as emulation suspend.

Figure B–349. Video Port Peripheral Control Register (PCR)

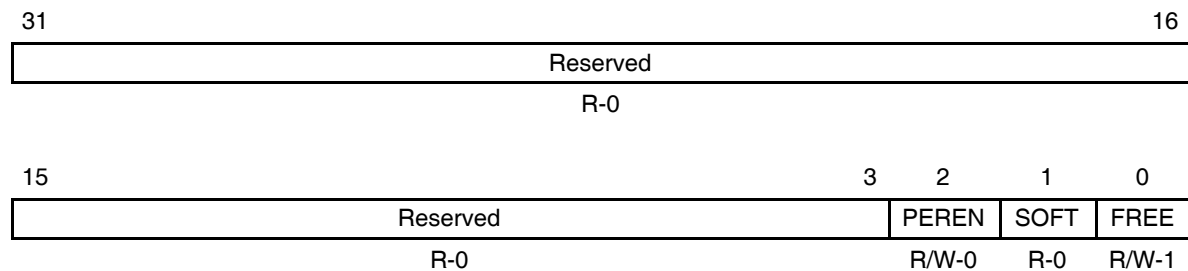

Legend: R = Read only; R/W = Read/Write; -n = value after reset

Table B–368. Video Port Peripheral Control Register (PCR) Field Values

Bit	field [†]	symval [†]	Value	Description
31–3	Reserved	–	0	Reserved. The reserved bit location is always read as 0. A value written to this field has no effect.
2	PEREN			Peripheral enable bit.
		DISABLE	0	Video port is disabled. Port clock (VCLK0, VCLK1, STCLK) inputs are gated off to save power. DMA access to the video port is still acknowledged but indeterminate read data is returned and write data is discarded.
		ENABLE	1	Video port is enabled.
1	SOFT			Soft bit enable mode bit. This bit is used in conjunction with FREE bit to determine state of video port clock during emulation suspend. This bit has no effect if FREE = 1.
		STOP	0	The current field is completed upon emulation suspend. After completion, no new DMA events are generated. The port clocks and counters continue to run in order to maintain synchronization. No interrupts are generated. If the port is in display mode, video control signals continue to be output and the default data value is output during the active video window.
		COMP	1	Is not defined for this peripheral; the bit is hardwired to 0.
0	FREE			Free-running enable mode bit. This bit is used in conjunction with SOFT bit to determine state of video port during emulation suspend.
		SOFT	0	Free-running mode is disabled. During emulation suspend, SOFT bit determines operation of video port.
			1	Free-running mode is enabled. Video port ignores the emulation suspend signal and continues to function as normal.

[†] For CSL implementation, use the notation `VP_PCR_field_symval`

B.25.3 Video Port Pin Function Register (PFUNC)

The video port pin function register (PFUNC) selects the video port pins as GPIO. The PFUNC is shown in Figure B–350 and described in Table B–369. Each bit controls either one pin or a set of pins. When a bit is set to 1, it enables the pin(s) that map to it as GPIO. The GPIO feature should not be used for pins that are used as part of the capture or display operation. For pins that have been muxed out for use by another peripheral, the PFUNC bits will have no effect.

The VDATA pins are broken into two functional groups: VDATA[9–0] and VDATA[19–10]. Thus, each entire half of the data bus must be configured as either functional pins or GPIO pins. In the case of single BT.656 or raw 8/10-bit mode, the upper 10 VDATA pins (VDATA[19–10]) can be used as GPIOs. If the video port is disabled, all pins can be used as GPIO.

Figure B–350. Video Port Pin Function Register (PFUNC)

31					23	22	21	20	19			16
Reserved					PFUNC22	PFUNC21	PFUNC20	Reserved				
R-0					R/W-0	R/W-0	R/W-0	R/W-0				
15				11	10	9					1	0
Reserved		PFUNC10		Reserved				PFUNC0				
R-0		R/W-0		R-0				R/W-0				

Legend: R = Read only; R/W = Read/Write; -n = value after reset

Table B–369. Video Port Pin Function Register (PFUNC) Field Values

Bit	field [†]	symval [†]	Value	Description
31–23	Reserved	–	0	Reserved. The reserved bit location is always read as 0. A value written to this field has no effect.
22	PFUNC22	NORMAL	0	Pin functions normally.
		VCTL2	1	Pin functions as GPIO pin.
21	PFUNC21	NORMAL	0	Pin functions normally.
		VCTL1	1	Pin functions as GPIO pin.

[†] For CSL implementation, use the notation VP_PFUNC_field_symval

Table B–369. Video Port Pin Function Register (PFUNC) Field Values (Continued)

Bit	field [†]	symval [†]	Value	Description
20	PFUNC20			PFUNC20 bit determines if VCTL0 pin functions as GPIO.
		NORMAL	0	Pin functions normally.
		VCTL0	1	Pin functions as GPIO pin.
19–11	Reserved	–	0	Reserved. The reserved bit location is always read as 0. A value written to this field has no effect.
10	PFUNC10			PFUNC10 bit determines if VDATA[19–10] pins function as GPIO.
		NORMAL	0	Pins function normally.
		VDATA10TO19	1	Pins function as GPIO pin.
9–1	Reserved	–	0	Reserved. The reserved bit location is always read as 0. A value written to this field has no effect.
0	PFUNC0			PFUNC0 bit determines if VDATA[9–0] pins function as GPIO.
		NORMAL	0	Pins function normally.
		VDATA0TO9	1	Pins function as GPIO pin.

[†] For CSL implementation, use the notation VP_PFUNC_*field_symval*

B.25.4 Video Port Pin Direction Register (PDIR)

The video port pin direction register (PDIR) is shown in Figure B–351 and described in Table B–370. The PDIR controls the direction of IO pins in the video port for those pins set by PFUNC. If a bit is set to 1, the relevant pin or pin group acts as an output. If a bit is cleared to 0, the pin or pin group functions as an input. The PDIR settings do not affect pins where the corresponding PFUNC bit is not set.

Figure B–351. Video Port Pin Direction Register (PDIR)

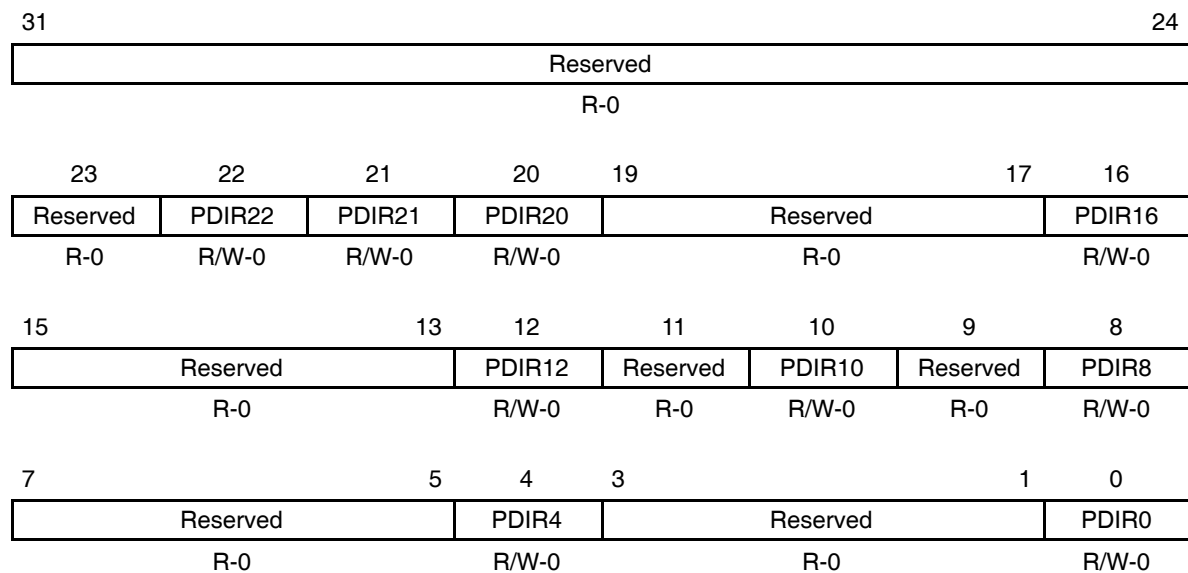

Legend: R = Read only; R/W = Read/Write; -n = value after reset

Table B–370. Video Port Pin Direction Register (PDIR) Field Values

Bit	field [†]	symval [†]	Value	Description
31–23	Reserved	–	0	Reserved. The reserved bit location is always read as 0. A value written to this field has no effect.
22	PDIR22			PDIR22 bit controls the direction of the VCTL2 pin.
		VCTL2IN	0	Pin functions as input.
		VCTL2OUT	1	Pin functions as output.

[†] For CSL implementation, use the notation VP_PDIR_field_symval

Table B–370. Video Port Pin Direction Register (PDIR) Field Values (Continued)

Bit	field [†]	symval [†]	Value	Description
21	PDIR21			PDIR21 bit controls the direction of the VCTL1 pin.
		VCTL1IN	0	Pin functions as input.
		VCTL1OUT	1	Pin functions as output.
20	PDIR20			PDIR20 bit controls the direction of the VCTL0 pin.
		VCTL0IN	0	Pin functions as input.
		VCTL0OUT	1	Pin functions as output.
19–17	Reserved	–	0	Reserved. The reserved bit location is always read as 0. A value written to this field has no effect.
16	PDIR16			PDIR16 bit controls the direction of the VDATA[19–16] pins.
		VDATA16TO19IN	0	Pins function as input.
		VDATA16TO19OUT	1	Pins function as output.
15–13	Reserved	–	0	Reserved. The reserved bit location is always read as 0. A value written to this field has no effect.
12	PDIR12			PDIR12 bit controls the direction of the VDATA[15–12] pins.
		VDATA12TO15IN	0	Pins function as input.
		VDATA12TO15OUT	1	Pins function as output.
11	Reserved	–	0	Reserved. The reserved bit location is always read as 0. A value written to this field has no effect.
10	PDIR10			PDIR10 bit controls the direction of the VDATA[11–10] pins.
		VDATA10TO11IN	0	Pins function as input.
		VDATA10TO11OUT	1	Pins function as output.
9	Reserved	–	0	Reserved. The reserved bit location is always read as 0. A value written to this field has no effect.

[†] For CSL implementation, use the notation VP_PDIR_field_symval

Table B–370. Video Port Pin Direction Register (PDIR) Field Values (Continued)

Bit	field [†]	symval [†]	Value	Description
8	PDIR8			PDIR8 bit controls the direction of the VDATA[9–8] pins.
		VDATA8TO9IN	0	Pins function as input.
		VDATA8TO9OUT	1	Pins function as output.
7–5	Reserved	–	0	Reserved. The reserved bit location is always read as 0. A value written to this field has no effect.
4	PDIR4			PDIR4 bit controls the direction of the VDATA[7–4] pins.
		VDATA4TO7IN	0	Pins function as input.
		VDATA4TO7OUT	1	Pins function as output.
3–1	Reserved	–	0	Reserved. The reserved bit location is always read as 0. A value written to this field has no effect.
0	PDIR0			PDIR0 bit controls the direction of the VDATA[3–0] pins.
		VDATA0TO3IN	0	Pins function as input.
		VDATA0TO3OUT	1	Pins function as output.

[†] For CSL implementation, use the notation VP_PDIR_field_symval

B.25.5 Video Port Pin Data Input Register (PDIN)

The read-only video port pin data input register (PDIN) is shown in Figure B–352 and described in Table B–371. PDIN reflects the state of the video port pins. When read, PDIN returns the value from the pin’s input buffer (with appropriate synchronization) regardless of the state of the corresponding PFUNC or PDIR bit.

Figure B–352. Video Port Pin Data Input Register (PDIN)

31	Reserved								24
R-0									
	23	22	21	20	19	18	17	16	
	Reserved	PDIN22	PDIN21	PDIN20	PDIN19	PDIN18	PDIN17	PDIN16	
	R-0	R-0	R-0	R-0	R-0	R-0	R-0	R-0	
	15	14	13	12	11	10	9	8	
	PDIN15	PDIN14	PDIN13	PDIN12	PDIN11	PDIN10	PDIN9	PDIN8	
	R-0	R-0	R-0	R-0	R-0	R-0	R-0	R-0	
	7	6	5	4	3	2	1	0	
	PDIN7	PDIN6	PDIN5	PDIN4	PDIN3	PDIN2	PDIN1	PDIN0	
	R-0	R-0	R-0	R-0	R-0	R-0	R-0	R-0	

Legend: R = Read only; -n = value after reset

Table B–371. Video Port Pin Data Input Register (PDIN) Field Values

Bit	field†	symval†	Value	Description
31–23	Reserved	–	0	Reserved. The reserved bit location is always read as 0. A value written to this field has no effect.
22	PDIN22			PDIN22 bit returns the logic level of the VCTL2 pin.
		VCTL2LO	0	Pin is logic low.
		VCTL2HI	1	Pin is logic high.
21	PDIN21			PDIN21 bit returns the logic level of the VCTL1 pin.
		VCTL1LO	0	Pin is logic low.
		VCTL1HI	1	Pin is logic high.
20	PDIN20			PDIN20 bit returns the logic level of the VCTL0 pin.
		VCTL0LO	0	Pin is logic low.
		VCTL0HI	1	Pin is logic high.
19–0	PDIN[19–0]			PDIN[19–0] bit returns the logic level of the corresponding VDATA[n] pin.
		VDATA n LO	0	Pin is logic low.
		VDATA n HI	1	Pin is logic high.

† For CSL implementation, use the notation VP_PDIN_PDIN n _symval

B.25.6 Video Port Pin Data Output Register (PDOUT)

The video port pin data output register (PDOUT) is shown in Figure B–353 and described in Table B–372. The bits of PDOUT determine the value driven on the corresponding GPIO pin, if the pin is configured as an output. Writes do not affect pins not configured as GPIO outputs. The bits in PDOUT are set or cleared by writing to this register directly. A read of PDOUT returns the value of the register not the value at the pin (that might be configured as an input). An alternative way to set bits in PDOUT is to write a 1 to the corresponding bit of PDSET. An alternative way to clear bits in PDOUT is to write a 1 to the corresponding bit of PDCLR.

PDOUT has these aliases:

- PDSET — writing a 1 to a bit in PDSET sets the corresponding bit in PDOUT to 1; writing a 0 has no effect and keeps the bits in PDOUT unchanged.
- PDCLR — writing a 1 to a bit in PDCLR clears the corresponding bit in PDOUT to 0; writing a 0 has no effect and keeps the bits in PDOUT unchanged.

Figure B–353. Video Port Pin Data Output Register (PDOUT)

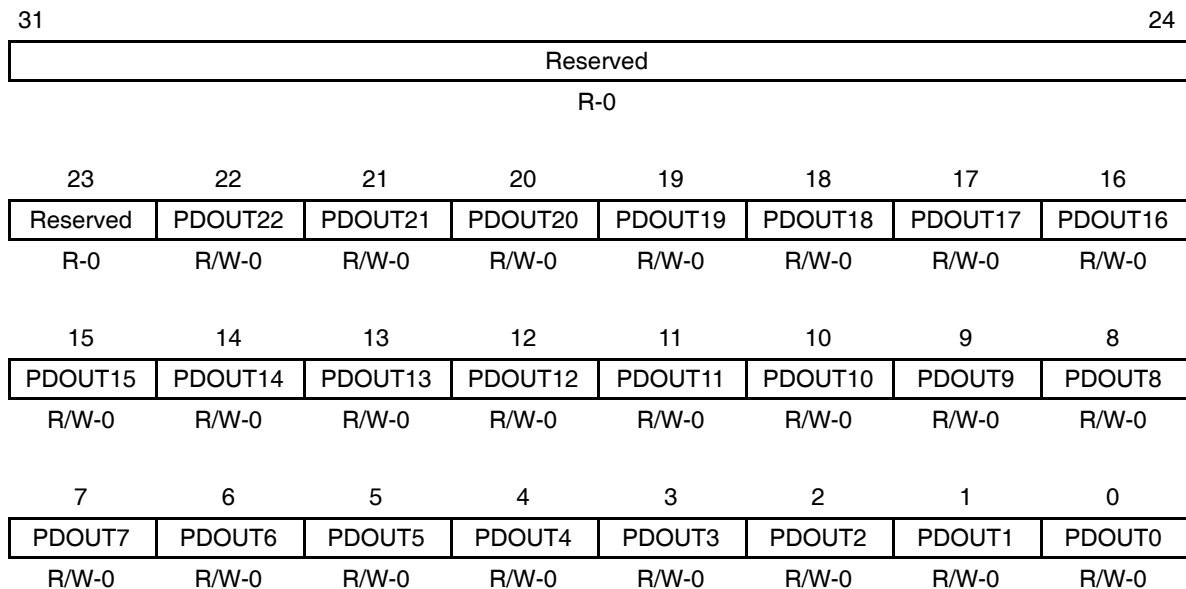

Legend: R = Read only; R/W = Read/Write; -n = value after reset

Table B–372. Video Port Pin Data Out Register (PDOUT) Field Values

Bit	field [†]	symval [†]	Value	Description
31–23	Reserved	–	0	Reserved. The reserved bit location is always read as 0. A value written to this field has no effect.
22	PDOUT22			PDOUT22 bit drives the VCTL2 pin only when the GPIO is configured as output. When reading data, returns the bit value in PDOUT22, does not return input from pin. When writing data, writes to PDOUT22 bit.
		VCTL2LO	0	Pin drives low.
		VCTL2HI	1	Pin drives high.
21	PDOUT21			PDOUT21 bit drives the VCTL1 pin only when the GPIO is configured as output. When reading data, returns the bit value in PDOUT21, does not return input from pin. When writing data, writes to PDOUT21 bit.
		VCTL1LO	0	Pin drives low.
		VCTL1HI	1	Pin drives high.
20	PDOUT20			PDOUT20 bit drives the VCTL0 pin only when the GPIO is configured as output. When reading data, returns the bit value in PDOUT20, does not return input from pin. When writing data, writes to PDOUT20 bit.
		VCTL0LO	0	Pin drives low.
		VCTL0HI	1	Pin drives high.
19–0	PDOUT[19–0]			PDOUT[19–0] bit drives the corresponding VDATA[19–0] pin only when the GPIO is configured as output. When reading data, returns the bit value in PDOUT[n], does not return input from pin. When writing data, writes to PDOUT[n] bit.
		VDATA _n LO	0	Pin drives low.
		VDATA _n HI	1	Pin drives high.

[†] For CSL implementation, use the notation VP_PDOUT_PDOUT_n_symval

B.25.7 Video Port Pin Data Set Register (PDSET)

The video port pin data set register (PDSET) is shown in Figure B–354 and described in Table B–373. PDSET is an alias of the video port pin data output register (PDOUT) for writes only and provides an alternate means of driving GPIO outputs high. Writing a 1 to a bit of PDSET sets the corresponding bit in PDOUT. Writing a 0 has no effect. Register reads return all 0s.

Figure B–354. Video Port Pin Data Set Register (PDSET)

31	Reserved								24
R-0									
23	22	21	20	19	18	17	16		
Reserved	PDSET22	PDSET21	PDSET20	PDSET19	PDSET18	PDSET17	PDSET16		
R-0	W-0	W-0	W-0	W-0	W-0	W-0	W-0		
15	14	13	12	11	10	9	8		
PDSET15	PDSET14	PDSET13	PDSET12	PDSET11	PDSET10	PDSET9	PDSET8		
W-0	W-0	W-0	W-0	W-0	W-0	W-0	W-0		
7	6	5	4	3	2	1	0		
PDSET7	PDSET6	PDSET5	PDSET4	PDSET3	PDSET2	PDSET1	PDSET0		
W-0	W-0	W-0	W-0	W-0	W-0	W-0	W-0		

Legend: R = Read only; W = Write only; -n = value after reset

Table B–373. Video Port Pin Data Set Register (PDSET) Field Values

Bit	field [†]	symval [†]	Value	Description
31–23	Reserved	–	0	Reserved. The reserved bit location is always read as 0. A value written to this field has no effect.
22	PDSET22			Allows PDOUT22 bit to be set to a logic high without affecting other I/O pins controlled by the same port.
		NONE	0	No effect.
		VCTL2HI	1	Sets PDOUT22 (VCTL2) bit to 1.
21	PDSET21			Allows PDOUT21 bit to be set to a logic high without affecting other I/O pins controlled by the same port.
		NONE	0	No effect.
		VCTL1HI	1	Sets PDOUT21 (1) bit to 1.
20	PDSET20			Allows PDOUT20 bit to be set to a logic high without affecting other I/O pins controlled by the same port.
		NONE	0	No effect.
		VCTL0HI	1	Sets PDOUT20 (VCTL0) bit to 1.
19–0	PDSET[19–0]			Allows PDOUT[19–0] bit to be set to a logic high without affecting other I/O pins controlled by the same port.
		NONE	0	No effect.
		VDATA _n HI	1	Sets PDOUT[<i>n</i>] (VDATA[<i>n</i>]) bit to 1.

[†] For CSL implementation, use the notation VP_PDSET_PDSET_{*n*}_symval

B.25.8 Video Port Pin Data Clear Register (PDCLR)

The video port pin data clear register (PDCLR) is shown in Figure B–355 and described in Table B–374. PDCLR is an alias of the video port pin data output register (PDOUT) for writes only and provides an alternate means of driving GPIO outputs low. Writing a 1 to a bit of PDCLR clears the corresponding bit in PDOUT. Writing a 0 has no effect. Register reads return all 0s.

Figure B–355. Video Port Pin Data Clear Register (PDCLR)

31	Reserved								24
R-0									
	23	22	21	20	19	18	17	16	
	Reserved	PDCLR22	PDCLR21	PDCLR20	PDCLR19	PDCLR18	PDCLR17	PDCLR16	
	R-0	W-0	W-0	W-0	W-0	W-0	W-0	W-0	
	15	14	13	12	11	10	9	8	
	PDCLR15	PDCLR14	PDCLR13	PDCLR12	PDCLR11	PDCLR10	PDCLR9	PDCLR8	
	W-0	W-0	W-0	W-0	W-0	W-0	W-0	W-0	
	7	6	5	4	3	2	1	0	
	PDCLR7	PDCLR6	PDCLR5	PDCLR4	PDCLR3	PDCLR2	PDCLR1	PDCLR0	
	W-0	W-0	W-0	W-0	W-0	W-0	W-0	W-0	

Legend: R = Read only; W = Write only; -n = value after reset

Table B–374. Video Port Pin Data Clear Register (PDCLR) Field Values

Bit	field [†]	symval [†]	Value	Description
31–23	Reserved	–	0	Reserved. The reserved bit location is always read as 0. A value written to this field has no effect.
22	PDCLR22			Allows PDOUT22 bit to be cleared to a logic low without affecting other I/O pins controlled by the same port.
		NONE	0	No effect.
		VCTL2CLR	1	Clears PDOUT22 (VCTL2) bit to 0.
21	PDCLR21			Allows PDOUT21 bit to be cleared to a logic low without affecting other I/O pins controlled by the same port.
		NONE	0	No effect.
		VCTL1CLR	1	Clears PDOUT21 (VCTL1) bit to 0.
20	PDCLR20			Allows PDOUT20 bit to be cleared to a logic low without affecting other I/O pins controlled by the same port.
		NONE	0	No effect.
		VCTL0CLR	1	Clears PDOUT20 (VCTL0) bit to 0.
19–0	PDCLR[19–0]			Allows PDOUT[19–0] bit to be cleared to a logic low without affecting other I/O pins controlled by the same port.
		NONE	0	No effect.
		VDATA _n CLR	1	Clears PDOUT[<i>n</i>] (VDATA[<i>n</i>]) bit to 0.

[†] For CSL implementation, use the notation VP_PDCLR_PDCLR_{*n*}_symval

B.25.9 Video Port Pin Interrupt Enable Register (PIEN)

The video port pin interrupt enable register (PIEN) is shown in Figure B–356 and described in Table B–375. The GPIOs can be used to generate DSP interrupts or DMA events. The PIEN selects which pins may be used to generate an interrupt. Only pins whose corresponding bits in PIEN are set may cause their corresponding PISTAT bit to be set.

Interrupts are enabled on a GPIO pin when the corresponding bit in PIEN is set, the pin is enabled for GPIO in PFUNC, and the pin is configured as an input in PDIR.

Figure B–356. Video Port Pin Interrupt Enable Register (PIEN)

31	Reserved								24
R-0									
23	22	21	20	19	18	17	16		
Reserved	PIEN22	PIEN21	PIEN20	PIEN19	PIEN18	PIEN17	PIEN16		
R-0	R/W-0	R/W-0	R/W-0	R/W-0	R/W-0	R/W-0	R/W-0		
15	14	13	12	11	10	9	8		
PIEN15	PIEN14	PIEN13	PIEN12	PIEN11	PIEN10	PIEN9	PIEN8		
R/W-0	R/W-0	R/W-0	R/W-0	R/W-0	R/W-0	R/W-0	R/W-0		
7	6	5	4	3	2	1	0		
PIEN7	PIEN6	PIEN5	PIEN4	PIEN3	PIEN2	PIEN1	PIEN0		
R/W-0	R/W-0	R/W-0	R/W-0	R/W-0	R/W-0	R/W-0	R/W-0		

Legend: R = Read only; R/W = Read/Write; -n = value after reset

Table B–375. Video Port Pin Interrupt Enable Register (PIEN) Field Values

Bit	field [†]	symval [†]	Value	Description
31–23	Reserved	–	0	Reserved. The reserved bit location is always read as 0. A value written to this field has no effect.
22	PIEN22			PIEN22 bit enables the interrupt on the VCTL2 pin.
		VCTL2LO	0	Interrupt is disabled.
		VCTL2HI	1	Pin enables the interrupt.
21	PIEN21			PIEN21 bit enables the interrupt on the VCTL1 pin.
		VCTL1LO	0	Interrupt is disabled.
		VCTL1HI	1	Pin enables the interrupt.
20	PIEN20			PIEN20 bit enables the interrupt on the VCTL0 pin.
		VCTL0LO	0	Interrupt is disabled.
		VCTL0HI	1	Pin enables the interrupt.
19–0	PIEN[19–0]			PIEN[19–0] bits enable the interrupt on the corresponding VDATA[n] pin.
		VDATA _n LO	0	Interrupt is disabled.
		VDATA _n HI	1	Pin enables the interrupt.

[†] For CSL implementation, use the notation VP_PIEN_PIEN_n_symval

B.25.10 Video Port Pin Interrupt Polarity Register (PIPOL)

The video port pin interrupt polarity register (PIPOL) is shown in Figure B–357 and described in Table B–376. The PIPOL determines the GPIO pin signal polarity that generates an interrupt.

Figure B–357. Video Port Pin Interrupt Polarity Register (PIPOL)

Reserved							
R-0							
23	22	21	20	19	18	17	16
Reserved	PIPOL22	PIPOL21	PIPOL20	PIPOL19	PIPOL18	PIPOL17	PIPOL16
R-0	R/W-0	R/W-0	R/W-0	R/W-0	R/W-0	R/W-0	R/W-0
15	14	13	12	11	10	9	8
PIPOL15	PIPOL14	PIPOL13	PIPOL12	PIPOL11	PIPOL10	PIPOL9	PIPOL8
R/W-0	R/W-0	R/W-0	R/W-0	R/W-0	R/W-0	R/W-0	R/W-0
7	6	5	4	3	2	1	0
PIPOL7	PIPOL6	PIPOL5	PIPOL4	PIPOL3	PIPOL2	PIPOL1	PIPOL0
R/W-0	R/W-0	R/W-0	R/W-0	R/W-0	R/W-0	R/W-0	R/W-0

Legend: R = Read only; R/W = Read/Write; -n = value after reset

Table B–376. Video Port Pin Interrupt Polarity Register (PIPOL) Field Values

Bit	field [†]	symval [†]	Value	Description
31–23	Reserved	–	0	Reserved. The reserved bit location is always read as 0. A value written to this field has no effect.
22	PIPOL22			PIPOL22 bit determines the VCTL2 pin signal polarity that generates an interrupt.
		VCTL2ACTHI	0	Interrupt is caused by a low-to-high transition on the VCTL2 pin.
		VCTL2ACTLO	1	Interrupt is caused by a high-to-low transition on the VCTL2 pin.
21	PIPOL21			PIPOL21 bit determines the VCTL1 pin signal polarity that generates an interrupt.
		VCTL1ACTHI	0	Interrupt is caused by a low-to-high transition on the VCTL1 pin.
		VCTL1ACTLO	1	Interrupt is caused by a high-to-low transition on the VCTL1 pin.
20	PIPOL20			PIPOL20 bit determines the VCTL0 pin signal polarity that generates an interrupt.
		VCTL0ACTHI	0	Interrupt is caused by a low-to-high transition on the VCTL0 pin.
		VCTL0ACTLO	1	Interrupt is caused by a high-to-low transition on the VCTL0 pin.
19–0	PIPOL[19–0]			PIPOL[19–0] bit determines the corresponding VDATA[n] pin signal polarity that generates an interrupt.
		VDATA _n ACTHI	0	Interrupt is caused by a low-to-high transition on the VDATA[n] pin.
		VDATA _n ACTLO	1	Interrupt is caused by a high-to-low transition on the VDATA[n] pin.

[†] For CSL implementation, use the notation VP_PIPOL_PIPOL_n_symval

B.25.11 Video Port Pin Interrupt Status Register (PISTAT)

The video port pin interrupt status register (PISTAT) is shown in Figure B–358 and described in Table B–377. PISTAT is a read-only register that indicates the GPIO pin that has a pending interrupt.

A bit in PISTAT is set when the corresponding GPIO pin is configured as an interrupt (the corresponding bit in PIEN is set, the pin is enabled for GPIO in PFUNC, and the pin is configured as an input in PDIR) and the appropriate transition (as selected by the corresponding PIPOL bit) occurs on the pin. Whenever a PISTAT bit is set to 1, the GPIO bit in VPIS is set. The PISTAT bits are cleared by writing a 1 to the corresponding bit in PICLR. Writing a 0 has no effect. Clearing all the PISTAT bits does not clear the GPIO bit in VPIS, it must be explicitly cleared. If any bits in PISTAT are still set when the GPIO bit is cleared, the GPIO bit is set again.

Figure B–358. Video Port Pin Interrupt Status Register (PISTAT)

31	Reserved								24
R-0									
23	22	21	20	19	18	17	16		
Reserved	PISTAT22	PISTAT21	PISTAT20	PISTAT19	PISTAT18	PISTAT17	PISTAT16		
R-0	R-0	R-0	R-0	R-0	R-0	R-0	R-0		
15	14	13	12	11	10	9	8		
PISTAT15	PISTAT14	PISTAT13	PISTAT12	PISTAT11	PISTAT10	PISTAT9	PISTAT8		
R-0	R-0	R-0	R-0	R-0	R-0	R-0	R-0		
7	6	5	4	3	2	1	0		
PISTAT7	PISTAT6	PISTAT5	PISTAT4	PISTAT3	PISTAT2	PISTAT1	PISTAT0		
R-0	R-0	R-0	R-0	R-0	R-0	R-0	R-0		

Legend: R = Read only; -n = value after reset

Table B–377. Video Port Pin Interrupt Status Register (PISTAT) Field Values

Bit	field [†]	symval [†]	Value	Description
31–23	Reserved	–	0	Reserved. The reserved bit location is always read as 0. A value written to this field has no effect.
22	PISTAT22			PISTAT22 bit indicates if there is a pending interrupt on the VCTL2 pin.
		NONE	0	No pending interrupt on the VCTL2 pin.
		VCTL2INT	1	Pending interrupt on the VCTL2 pin.
21	PISTAT21			PISTAT21 bit indicates if there is a pending interrupt on the VCTL1 pin.
		NONE	0	No pending interrupt on the VCTL1 pin.
		VCTL1INT	1	Pending interrupt on the VCTL1 pin.
20	PISTAT20			PISTAT20 bit indicates if there is a pending interrupt on the VCTL0 pin.
		NONE	0	No pending interrupt on the VCTL0 pin.
		VCTL0INT	1	Pending interrupt on the VCTL0 pin.
19–0	PISTAT[19–0]			PISTAT[19–0] bit indicates if there is a pending interrupt on the corresponding VDATA[n] pin.
		NONE	0	No pending interrupt on the VDATA[n] pin.
		VDATA[n]INT	1	Pending interrupt on the VDATA[n] pin.

[†] For CSL implementation, use the notation VP_PISTAT_PISTAT n _symval

B.25.12 Video Port Pin Interrupt Clear Register (PICLR)

The video port pin interrupt clear register (PICLR) is shown in Figure B–359 and described in Table B–378. PICLR is an alias of the video port pin interrupt status register (PISTAT) for writes only. Writing a 1 to a bit of PICLR clears the corresponding bit in PISTAT. Writing a 0 has no effect. Register reads return all 0s.

Figure B–359. Video Port Pin Interrupt Clear Register (PICLR)

Reserved							
R-0							
23	22	21	20	19	18	17	16
Reserved	PICLR22	PICLR21	PICLR20	PICLR19	PICLR18	PICLR17	PICLR16
R-0	W-0	W-0	W-0	W-0	W-0	W-0	W-0
15	14	13	12	11	10	9	8
PICLR15	PICLR14	PICLR13	PICLR12	PICLR11	PICLR10	PICLR9	PICLR8
W-0	W-0	W-0	W-0	W-0	W-0	W-0	W-0
7	6	5	4	3	2	1	0
PICLR7	PICLR6	PICLR5	PICLR4	PICLR3	PICLR2	PICLR1	PICLR0
W-0	W-0	W-0	W-0	W-0	W-0	W-0	W-0

Legend: R = Read only; W = Write only; -n = value after reset

Table B–378. Video Port Pin Interrupt Clear Register (PICLR) Field Values

Bit	field [†]	symval [†]	Value	Description
31–23	Reserved	–	0	Reserved. The reserved bit location is always read as 0. A value written to this field has no effect.
22	PICLR22			Allows PISTAT22 bit to be cleared to a logic low.
		NONE	0	No effect.
		VCTL2CLR	1	Clears PISTAT22 (VCTL2) bit to 0.
21	PICLR21			Allows PISTAT21 bit to be cleared to a logic low.
		NONE	0	No effect.
		VCTL1CLR	1	Clears PISTAT21 (VCTL1) bit to 0.
20	PICLR20			Allows PISTAT20 bit to be cleared to a logic low.
		NONE	0	No effect.
		VCTL0CLR	1	Clears PISTAT20 (VCTL0) bit to 0.
19–0	PICLR[19–0]			Allows PISTAT[19–0] bit to be cleared to a logic low.
		NONE	0	No effect.
		VDATA _n CLR	1	Clears PISTAT[<i>n</i>] (VDATA[<i>n</i>]) bit to 0.

[†] For CSL implementation, use the notation VP_PICLR_PICLR_n_symval

B.26 Expansion Bus (XBUS) Registers

Table B–379. Expansion Bus Registers

Acronym	Register Name	Read/Write Access		Section
		DSP	Host	
XBGC	Expansion bus global control register			B.26.1
XCECTL0-3	Expansion bus XCE space control registers			B.26.2
XBHC	Expansion bus host port interface control register	R/W	—	B.26.3
XBIMA	Expansion bus internal master address register	R/W	—	B.26.4
XBEA	Expansion bus external address register	R/W	—	B.26.5
XBD	Expansion bus data register	—	R/W	B.26.6
XBISA	Expansion bus internal slave address register	—	R/W	B.26.7

B.26.1 Expansion Bus Global Control Register (XBGC)

Figure B–360. Expansion Bus Global Control Register (XBGC)

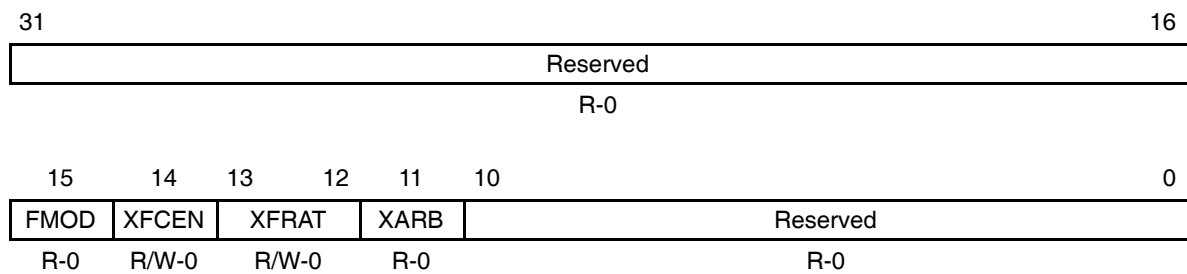

Legend: R = Read only; R/W = Read/Write; -n = value after reset

Table B–380. Expansion Bus Global Control Register (XBGC) Field Values

Bit	field [†]	symval [†]	Value	Description
31–16	Reserved	–	0	Reserved. The reserved bit location is always read as 0. A value written to this field has no effect.
15	FMOD			FIFO boot-mode selection bit.
		GLUE	0	Glue logic is used for FIFO read interface in all XCE spaces operating in FIFO mode.
		GLUELESS	1	Glueless read FIFO interface. If $\overline{XCE3}$ is selected for FIFO mode, then XOE acts as FIFO output enable and $\overline{XCE3}$ acts as FIFO read enable. XOE is disabled in all other XCE spaces regardless of MTYPE setting in XCECTL.
14	XFCEN			FIFO clock enable bit. The FIFO clock enable cannot be changed while a DMA request to XCE space is active.
		DISABLE	0	XFCLK is held high.
		ENABLE	1	XFCLK is enabled to clock.
13–12	XFRAT		0–3h	FIFO clock rate bits. The FIFO clock setting cannot be changed while a DMA request to XCE space is active. The XFCLK should be disabled before changing the XFRAT bits. There is no delay required between enabling/disabling XFCLK and changing the XFRAT bits.
		ONEEIGHTH	0	XFCLK = 1/8 CPU clock rate
		ONESIXTH	1h	XFCLK = 1/6 CPU clock rate
		ONEFOURTH	2h	XFCLK = 1/4 CPU clock rate
		ONEHALF	3h	XFCLK = 1/2 CPU clock rate
11	XARB			Arbitration mode select bit.
		DISABLE	0	Internal arbiter is disabled. DSP wakes up from reset as the bus slave.
		ENABLE	1	Internal arbiter is enabled. DSP wakes up from reset as the bus master.
10–0	Reserved	–	0	Reserved. The reserved bit location is always read as 0. A value written to this field has no effect.

[†] For CSL implementation, use the notation `XBUS_XBGC_field_symval`

B.26.2 Expansion Bus XCE Space Control Registers (XCECTL0–3)

Figure B–361. Expansion Bus XCE Space Control Register (XCECTL)

31	28	27	22	21	20	19	16			
WRSETUP		WRSTRB			WRHLD		RDSETUP			
R/W-1111		R/W-11 1111			R/W-11		R/W-1111			
15	14	13	8	7	6	4	3	2	1	0
Reserved		RDSTRB			—	MTYPE		Reserved		RDHLD
R-0		R/W-11 1111			R-0	R/W-0		R-0		R/W-11

Legend: R = Read only; R/W = Read/Write; -n = value after reset

Table B–381. Expansion Bus XCE Space Control Register (XCECTL)
Field Values

Bit	field [†]	symval [†]	Value	Description
31–28	WRSETUP	OF(value)	0–Fh	Write setup width. Number of CLKOUT1 cycles of setup time for byte-enable/address (\overline{XBE}/XA) and chip enable (\overline{XCE}) before write strobe falls. For asynchronous read accesses, this is also the setup time of \overline{XOE} before \overline{XRE} falls.
		DEFAULT	Fh	Write setup width is 15 CLKOUT1 cycles.
27–22	WRSTRB	OF(value)	0–3Fh	Write strobe width. The width of write strobe (\overline{XWE}) in CLKOUT1 cycles.
		DEFAULT	3Fh	Width of write strobe (\overline{XWE}) is 63 CLKOUT1 cycles.
21–20	WRHLD	OF(value)	0–3h	Write hold width. Number of CLKOUT1 cycles that byte-enable/address (\overline{XBE}/XA) and chip enable (\overline{XCE}) are held after write strobe rises. For asynchronous read accesses, this is also the hold time of \overline{XCE} after \overline{XRE} rising.
		DEFAULT	3h	Write hold width is 3 CLKOUT1 cycles.
19–16	RDSETUP	OF(value)	0–Fh	Read setup width. Number of CLKOUT1 cycles of setup time for byte-enable/address (\overline{XBE}/XA) and chip enable (\overline{XCE}) before read strobe falls. For asynchronous read accesses, this is also the setup time of \overline{XOE} before \overline{XRE} falls.
		DEFAULT	Fh	Read setup width is 15 CLKOUT1 cycles.

[†] For CSL implementation, use the notation `XBUS_XCECTL_field_symval`

Table B–381. Expansion Bus XCE Space Control Register (XCECTL)
Field Values (Continued)

Bit	field [†]	symval [†]	Value	Description
15–14	Reserved	–	0	Reserved. The reserved bit location is always read as 0. A value written to this field has no effect.
13–8	RDSTRB	OF(value)	0–3Fh	Read strobe width. The width of read strobe (\overline{XRE}) in CLKOUT1 cycles.
		DEFAULT	3Fh	Width of read strobe (\overline{XRE}) is 63 CLKOUT1 cycles
7	Reserved	–	0	Reserved. The reserved bit location is always read as 0. A value written to this field has no effect.
6–4	MTYPE	–	0–7h	Memory type is configured during boot using pull-up or pull-down resistors on the expansion bus.
		–	0–1h	Reserved
		32BITASYN	2h	32-bit wide asynchronous interface
		–	3h–4h	Reserved
		32BITFIFO	5h	32-bit wide FIFO interface
		–	6h–7h	Reserved
3–2	Reserved	–	0	Reserved. The reserved bit location is always read as 0. A value written to this field has no effect.
1–0	RDHLD	OF(value)	0–3h	Read hold width. Number of CLKOUT1 cycles that byte-enable/address (\overline{XBE}/XA) and chip enable (\overline{XCE}) are held after read strobe rises. For asynchronous read accesses, this is also the hold time of \overline{XCE} after \overline{XRE} rising.
		DEFAULT	3h	Read hold width is 3 CLKOUT1 cycles.

[†] For CSL implementation, use the notation `XBUS_XCECTL_field_symval`

B.26.3 Expansion Bus Host Port Interface Control Register (XBHC)

Figure B–362. Expansion Bus Host Port Interface Control Register (XBHC)

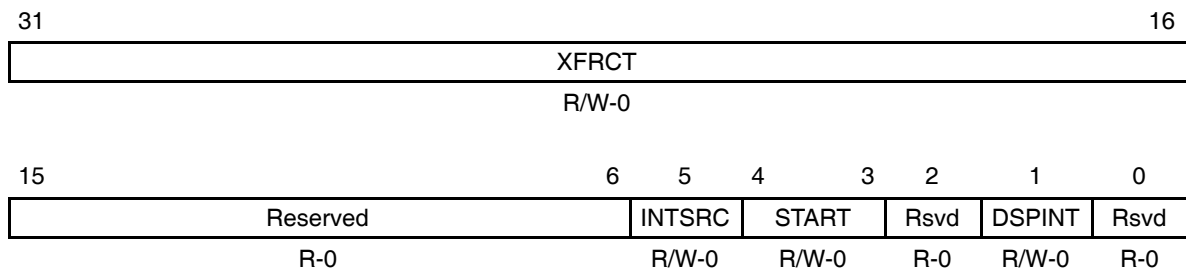

Legend: R = Read only; R/W = Read/Write; -n = value after reset

Table B–382. Expansion Bus Host Port Interface Control Register (XBHC)
Field Values

Bit	field [†]	symval [†]	Value	Description
31–16	XFRCT	OF(<i>value</i>)	0–FFFFh	Transfer counter bits control the number of 32-bit words transferred between the expansion bus and an external slave when the CPU is mastering the bus (range of up to 64k).
15–6	Reserved	–	0	Reserved. The reserved bit location is always read as 0. A value written to this field has no effect.
5	INTSRC			The interrupt source bit selects between the DSPINT bit of the expansion bus internal slave address register (XBISA) and the XFRCT counter. An XBUS host port interrupt can be caused either by the DSPINT bit or by the XFRCT counter.
		INTSRC	0	Interrupt source is the DSPINT bit of XBISA. When a zero is written to the INTSRC bit, the DSPINT bit of XBISA is copied to the DSPINT bit of XBHC.
		INTSRC	1	Interrupt is generated at the completion of the master transfer initiated by writing to the START bits.

[†] For CSL implementation, use the notation `XBUS_XBHC_field_symval`

**Table B–382. Expansion Bus Host Port Interface Control Register (XBHC)
Field Values (Continued)**

Bit	field†	symval†	Value	Description
4–3	START		0–3h	Start bus master transaction bit.
		ABORT	0	Writing 00 to the the START field while an active transfer is stalled by XRDY high, aborts the transfer. When a transfer is aborted, the XBUS registers reflect the state of the aborted transfer. Using this state information, you can restart the transfer.
		WRITE	1h	Starts a burst write transaction from the address pointed to by the expansion bus internal master address register (XBIMA) to the address pointed to by the expansion bus external address register (XBEA).
		READ	2h	Starts a burst read transaction from the address pointed to by the expansion bus external address register (XBEA) to the address pointed to by the expansion bus internal master address register (XBIMA).
		–	3h	Reserved
2	Reserved	–	0	Reserved. The reserved bit location is always read as 0. A value written to this field has no effect.
1	DSPINT			The expansion bus to DSP interrupt (set either by the external host or the completion of a master transfer) is cleared when this bit is set. The DSPINT bit must be manually cleared before another one can be set.
		NONE	0	DSP interrupt bit is not cleared.
		CLR	1	DSP interrupt bit is cleared.
0	Reserved	–	0	Reserved. The reserved bit location is always read as 0. A value written to this field has no effect.

† For CSL implementation, use the notation `XBUS_XBHC_field_symval`

B.26.4 Expansion Bus Internal Master Address Register (XBIMA)

Figure B–363. Expansion Bus Internal Master Address Register (XBIMA)

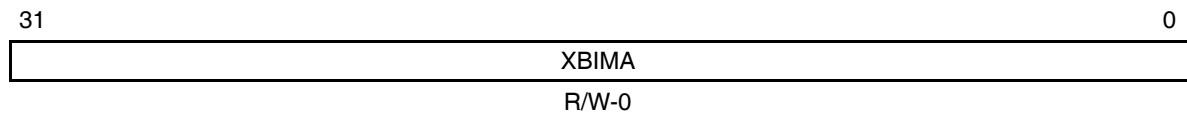

Legend: R/W = Read/Write; -n = value after reset

Table B–383. Expansion Bus Internal Master Address Register (XBIMA) Field Values

Bit	Field	symval [†]	Value	Description
31–0	XBIMA	OF(value)	0–FFFF FFFFh	Specifies the source or destination address in the DSP memory map where the transaction starts.

[†] For CSL implementation, use the notation `XBUS_XBIMA_XBIMA_symval`

B.26.5 Expansion Bus External Address Register (XBEA)

Figure B–364. Expansion Bus External Address Register (XBEA)

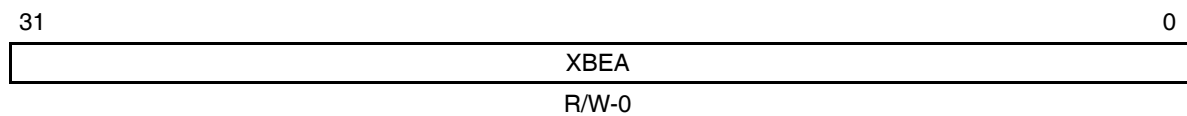

Legend: R/W = Read/Write; -n = value after reset

Table B–384. Expansion Bus External Address Register (XBEA) Field Values

Bit	Field	symval [†]	Value	Description
31–0	XBEA	OF(value)	0–FFFF FFFFh	Specifies the source or destination address in the external slave memory map where the data is accessed.

[†] For CSL implementation, use the notation `XBUS_XBEA_XBEA_symval`

B.26.6 Expansion Bus Data Register (XBD)

Figure B–365. Expansion Bus Data Register (XBD)

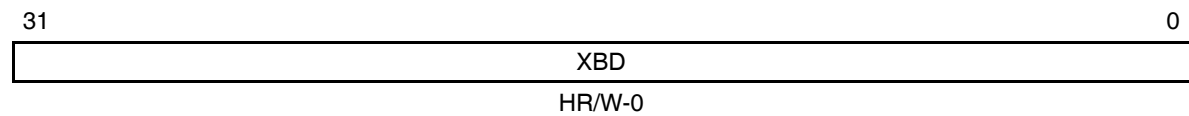

Legend: H = Host access; R/W = Read/Write; -n = value after reset

Table B–385. Expansion Bus Data Register (XBD) Field Values

Bit	Field	Value	Description
31–0	XBD	0–FFFF FFFFh	Contains the data that was read from the memory accessed by the XBUS host port, if the current access is a read; contains the data that is written to the memory, if the current access is a write.

B.26.7 Expansion Bus Internal Slave Address Register (XBISA)

Figure B–366. Expansion Bus Internal Slave Address Register (XBISA)

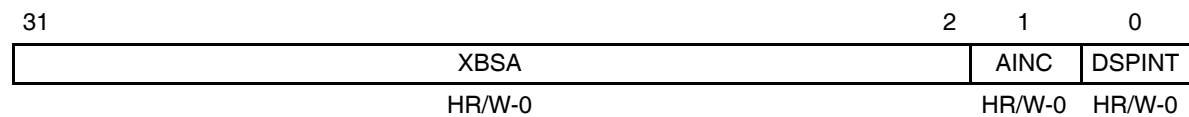

Legend: H = Host access; R/W = Read/Write; -n = value after reset

Table B–386. Expansion Bus Internal Slave Address Register (XBISA) Field Values

Bit	Field	Value	Description
31–2	XBSA	0–3FFF FFFFh	This 30-bit word address specifies the memory location in the DSP memory map being accessed by the host.
1	AINC		Autoincrement mode enable bit. (Asynchronous mode only)
		0	The expansion bus data register (XBD) is accessed with autoincrement of XBSA bits.
		1	The expansion bus data register (XBD) is accessed without autoincrement of XBSA bits.
0	DSPINT	0–1	The external master to DSP interrupt bit. Used to wake up the DSP from reset. The DSPINT bit is cleared by the corresponding DSPINT bit in the expansion bus host port interface control register (XBHC).

Old and New CACHE APIs

The L2 cache register names and the CSL cache coherence APIs have been renamed to better reflect the actual operation. All users are encouraged to switch from the old APIs to the new ones. The old APIs will still work, but will no longer be updated. Also, the old CSL version does not support some new C64x cache operations. Table C–1 and Table C–2 show the correct function calls for the new APIs, to replace the old ones. Table C–3 shows the mapping of the old L2 register names to the new L2 register names. Table C–4 shows the mapping of the new L2ALLOCx bit field names to the old bit field names (C64x only).

Table C–1. CSL APIs for L2 Cache Operations

Scope	Operation	Old API	New API†
Block	L2 Invalidate (C64x only)	N/A	CACHE_invL2(start address, byte count, CACHE_WAIT)
	L2 Writeback	CACHE_flush(CACHE_L2, start address, word count)	CACHE_wbL2(start address, byte count, CACHE_WAIT)
	L2 Writeback–Invalidate	CACHE_clean(CACHE_L2, start address, word count)	CACHE_wbInvL2(start address, byte count, CACHE_WAIT)
All L2 Cache	L2 Writeback All	CACHE_flush(CACHE_L2ALL, [ignored], [ignored])	CACHE_wbAllL2(CACHE_WAIT)
	L2 Writeback–Invalidate All	CACHE_clean(CACHE_L2ALL, [ignored], [ignored])	CACHE_wbInvAllL2(CACHE_WAIT)

† Refer to the CACHE chapter for the complete description of API.

Table C–2. CSL APIs for L1 Cache Operations

Scope	Operation	Old CSL Commands	New CSL Commands
Block	L1D Invalidate (C64x only)	N/A	CACHE_invL1d(start address, byte count, CACHE_WAIT)
	L1D Writeback–Invalidate	CACHE_flush(CACHE_L1D, start address, word count)	CACHE_wbInvL1d(start address, byte count, CACHE_WAIT)
	L1P Invalidate	CACHE_invalidate(CACHE_L1P, start address, word count)	CACHE_invL1p(start address, byte count, CACHE_WAIT)
All	L1P Invalidate	CACHE_invalidate(CACHE_L1PALL, [ignored], [ignored])	CACHE_invAll1p()

Table C–3. Mapping of Old L2 Register Names to New L2 Register Names

Old Register Name	New Register Name	Description
L2CLEAN	L2WBINV	L2 Writeback–Invalidate All
L2FLUSH	L2WB	L2 Writeback All
L2CBAR	L2WIBAR	L2 Writeback–Invalidate Base Address Register
L2CWC	L2WIWC	L2 Writeback–Invalidate Word Count
L2FBAR	L2WBAR	L2 Writeback Base Address Register
L2FWC	L2WWC	L2 Writeback Word Count
L2IBAR	L2IBAR	L2 Invalidate Base Address Register (C64x only)
L2IWC	L2IWC	L2 Invalidate Word Count (C64x only)
L1DFBAR	L1DWIBAR	L1D Writeback–Invalidate Base Address Register
L1DFWC	L1DWIWC	L1D Writeback–Invalidate Word Count
L1DIBAR	L1DIBAR	L1D Invalidate Base Address Register (C64x only)
L1DIWC	L1DIWC	L1D Invalidate Word Count (C64x only)
L1PFBAR	L1PIBAR	L1P Invalidate Base Address Register
L1PFWC	L1PIWC	L1P Invalidate Word Count

Table C–4. Mapping of New L2ALLOCx Bit Field Names to Old Bit Field Names (C64x only)

Register	Old Bit Field Names	New Bit Field Names	Description
L2ALLOC1	L2ALLOC	Q1CNT	L2 allocation priority queue 1
L2ALLOC2	L2ALLOC	Q2CNT	L2 allocation priority queue 2
L2ALLOC3	L2ALLOC	Q3CNT	L2 allocation priority queue 3
L2ALLOC4	L2ALLOC	Q4CNT	L2 allocation priority queue 4

Glossary

A

address: The location of program code or data stored; an individually accessible memory location.

A-law companding: See *compress and expand (compand)*.

API: See *application programming interface*.

API module: A set of API functions designed for a specific purpose.

application programming interface (API): Used for proprietary application programs to interact with communications software or to conform to protocols from another vendor's product.

assembler: A software program that creates a machine language program from a source file that contains assembly language instructions, directives, and macros. The assembler substitutes absolute operation codes for symbolic operation codes and absolute or relocatable addresses for symbolic addresses.

assert: To make a digital logic device pin active. If the pin is active low, then a low voltage on the pin asserts it. If the pin is active high, then a high voltage asserts it.

B

bit: A binary digit, either a 0 or 1.

big endian: An addressing protocol in which bytes are numbered from left to right within a word. More significant bytes in a word have lower numbered addresses. Endian ordering is specific to hardware and is determined at reset. See also *little endian*.

block: The three least significant bits of the program address. These correspond to the address within a fetch packet of the first instruction being addressed.

board support library (BSL): The BSL is a set of application programming interfaces (APIs) consisting of target side DSP code used to configure and control board level peripherals.

boot: The process of loading a program into program memory.

boot mode: The method of loading a program into program memory. The C6000 DSP supports booting from external ROM or the host port interface (HPI).

BSL: *See board support library.*

byte: A sequence of eight adjacent bits operated upon as a unit.

C

cache: A fast storage buffer in the central processing unit of a computer.

cache module: CACHE is an API module containing a set of functions for managing data and program cache.

cache controller: System component that coordinates program accesses between CPU program fetch mechanism, cache, and external memory.

CCS: Code Composer Studio.

central processing unit (CPU): The portion of the processor involved in arithmetic, shifting, and Boolean logic operations, as well as the generation of data- and program-memory addresses. The CPU includes the central arithmetic logic unit (CALU), the multiplier, and the auxiliary register arithmetic unit (ARAU).

CHIP: *See CHIP module.*

CHIP module: The CHIP module is an API module where chip-specific and device-related code resides. CHIP has some API functions for obtaining device endianness, memory map mode if applicable, CPU and REV IDs, and clock speed.

chip support library (CSL): The CSL is a set of application programming interfaces (APIs) consisting of target side DSP code used to configure and control all on-chip peripherals.

clock cycle: A periodic or sequence of events based on the input from the external clock.

clock modes: Options used by the clock generator to change the internal CPU clock frequency to a fraction or multiple of the frequency of the input clock signal.

code: A set of instructions written to perform a task; a computer program or part of a program.

coder-decoder or compression/decompression (codec): A device that codes in one direction of transmission and decodes in another direction of transmission.

compiler: A computer program that translates programs in a high-level language into their assembly-language equivalents.

compress and expand (compand): A quantization scheme for audio signals in which the input signal is compressed and then, after processing, is reconstructed at the output by expansion. There are two distinct companding schemes: A-law (used in Europe) and μ -law (used in the United States).

control register: A register that contains bit fields that define the way a device operates.

control register file: A set of control registers.

CSL: See *chip support library*.

CSL module: The CSL module is the top-level CSL API module. It interfaces to all other modules and its main purpose is to initialize the CSL library.

D

DAT: *Data; see DAT module.*

DAT module: The DAT is an API module that is used to move data around by means of DMA/EDMA hardware. This module serves as a level of abstraction that works the same for devices that have the DMA or EDMA peripheral.

device ID: Configuration register that identifies each peripheral component interconnect (PCI).

digital signal processor (DSP): A semiconductor that turns analog signals such as sound or light into digital signals (discrete or discontinuous electrical impulses) so that they can be manipulated.

direct memory access (DMA): A mechanism whereby a device other than the host processor contends for and receives mastery of the memory bus so that data transfers can take place independent of the host.

DMA : See *direct memory access*.

DMA module: DMA is an API module that currently has two architectures used on C6x devices: DMA and EDMA (enhanced DMA). Devices such as the 6201 have the DMA peripheral, whereas the 6211 has the EDMA peripheral.

DMA source: The module where the DMA data originates. DMA data is read from the DMA source.

DMA transfer: The process of transferring data from one part of memory to another. Each DMA transfer consists of a read bus cycle (source to DMA holding register) and a write bus cycle (DMA holding register to destination).

E

EDMA: *Enhanced direct memory access; see EDMA module.*

EDMA module: EDMA is an API module that currently has two architectures used on C6x devices: DMA and EDMA (enhanced DMA). Devices such as the 6201 have the DMA peripheral, whereas the 6211 has the EDMA peripheral.

:EMAC:EMAC is an API module for the Ethernet Media Access Control Module of the DM64x devices.

EMIF: *See external memory interface; see also EMIF module.*

EMIF module: EMIF is an API module that is used for configuring the EMIF registers.

evaluation module (EVM): Board and software tools that allow the user to evaluate a specific device.

external interrupt: A hardware interrupt triggered by a specific value on a pin.

external memory interface (EMIF): Microprocessor hardware that is used to read to and write from off-chip memory.

F

fetch packet: A contiguous 8-word series of instructions fetched by the CPU and aligned on an 8-word boundary.

flag: A binary status indicator whose state indicates whether a particular condition has occurred or is in effect.

frame: An 8-word space in the cache RAMs. Each fetch packet in the cache resides in only one frame. A cache update loads a frame with the requested fetch packet. The cache contains 512 frames.

G

global interrupt enable bit (GIE): A bit in the control status register (CSR) that is used to enable or disable maskable interrupts.

H

host: A device to which other devices (peripherals) are connected and that generally controls those devices.

host port interface (HPI): A parallel interface that the CPU uses to communicate with a host processor.

HPI: See *host port interface*; see also *HPI module*.

HPI module: HPI is an API module used for configuring the HPI registers. Functions are provided for reading HPI status bits and setting interrupt events.

I

index: A relative offset in the program address that specifies which of the 512 frames in the cache into which the current access is mapped.

indirect addressing: An addressing mode in which an address points to another pointer rather than to the actual data; this mode is prohibited in RISC architecture.

instruction fetch packet: A group of up to eight instructions held in memory for execution by the CPU.

internal interrupt: A hardware interrupt caused by an on-chip peripheral.

interrupt: A signal sent by hardware or software to a processor requesting attention. An interrupt tells the processor to suspend its current operation, save the current task status, and perform a particular set of instructions. Interrupts communicate with the operating system and prioritize tasks to be performed.

interrupt service fetch packet (ISFP): A fetch packet used to service interrupts. If eight instructions are insufficient, the user must branch out of this block for additional interrupt service. If the delay slots of the branch do not reside within the ISFP, execution continues from execute packets in the next fetch packet (the next ISFP).

interrupt service routine (ISR): A module of code that is executed in response to a hardware or software interrupt.

interrupt service table (IST) A table containing a corresponding entry for each of the 16 physical interrupts. Each entry is a single-fetch packet and has a label associated with it.

Internal peripherals: Devices connected to and controlled by a host device. The C6x internal peripherals include the direct memory access (DMA) controller, multichannel buffered serial ports (McBSPs), host port interface (HPI), external memory-interface (EMIF), and runtime support timers.

IRQ: *Interrupt request; see IRQ module.*

IRQ module: IRQ is an API module that manages CPU interrupts.

IST: *See interrupt service table.*

L

least significant bit (LSB): The lowest-order bit in a word.

linker: A software tool that combines object files to form an object module, which can be loaded into memory and executed.

little endian: An addressing protocol in which bytes are numbered from right to left within a word. More significant bytes in a word have higher-numbered addresses. Endian ordering is specific to hardware and is determined at reset. See also *big endian*.

M

μ -law companding: *See compress and expand (compand).*

maskable interrupt: A hardware interrupt that can be enabled or disabled through software.

MCBSP: *See multichannel buffered serial port; see also MCBSP module.*

MCBSP module: MCBSP is an API module that contains a set of functions for configuring the McBSP registers.

:MDIO MDIO is an API module for the Management of Data I/O module of the DM642, DM641, and DM640 devices.

memory map: A graphical representation of a computer system's memory, showing the locations of program space, data space, reserved space, and other memory-resident elements.

memory-mapped register: An on-chip register mapped to an address in memory. Some memory-mapped registers are mapped to data memory, and some are mapped to input/output memory.

most significant bit (MSB): The highest order bit in a word.

multichannel buffered serial port (McBSP): An on-chip full-duplex circuit that provides direct serial communication through several channels to external serial devices.

multiplexer: A device for selecting one of several available signals.

N

nonmaskable interrupt (NMI): An interrupt that can be neither masked nor disabled.

O

object file: A file that has been assembled or linked and contains machine language object code.

off chip: A state of being external to a device.

on chip: A state of being internal to a device.

P

PCI: *Peripheral component interconnect interface; see PCI module.*

PCI module: PCI is an API module that includes APIs which are dedicated to DSP-PCI Master transfers, EEPROM operations, and power management

peripheral: A device connected to and usually controlled by a host device.

program cache: A fast memory cache for storing program instructions allowing for quick execution.

program memory: Memory accessed through the C6x's program fetch interface.

PWR: *Power; see PWR module.*

PWR module: PWR is an API module that is used to configure the power-down control registers, if applicable, and to invoke various power-down modes.

R

random-access memory (RAM): A type of memory device in which the individual locations can be accessed in any order.

register: A small area of high speed memory located within a processor or electronic device that is used for temporarily storing data or instructions. Each register is given a name, contains a few bytes of information, and is referenced by programs.

reduced-instruction-set computer (RISC): A computer whose instruction set and related decode mechanism are much simpler than those of micro-programmed complex instruction set computers. The result is a higher instruction throughput and a faster real-time interrupt service response from a smaller, cost-effective chip.

reset: A means of bringing the CPU to a known state by setting the registers and control bits to predetermined values and signaling execution to start at a specified address.

RTOS *Real-time operating system.*

S

synchronous-burst static random-access memory (SBSRAM): RAM whose contents does not have to be refreshed periodically. Transfer of data is at a fixed rate relative to the clock speed of the device, but the speed is increased.

synchronous dynamic random-access memory (SDRAM): RAM whose contents is refreshed periodically so the data is not lost. Transfer of data is at a fixed rate relative to the clock speed of the device.

syntax: The grammatical and structural rules of a language. All higher-level programming languages possess a formal syntax.

system software: The blanketing term used to denote collectively the chip support libraries and board support libraries.

T

tag: The 18 most significant bits of the program address. This value corresponds to the physical address of the fetch packet that is in that frame.

timer: A programmable peripheral used to generate pulses or to time events.

TIMER module: TIMER is an API module used for configuring the timer registers.

V

:VCP: VCP is an API module for the Viterbi co-processor peripheral on the TMS320C6416 device.

:VIC: VIC is an API module for the VCXO interpolated control peripheral.

:VP: VP is an API module for the video port peripheral.

W

word: A multiple of eight bits that is operated upon as a unit. For the C6000, a word is 32 bits in length.

X

xbus: Expansion bus.

XBUS module: The XBUS module is an API module used for configuring the tXBUS registers.

Index

A

- A-law companding, defined D-1
- address, defined D-1
- API, defined D-1
- API module, defined D-1
- API reference, DAT API reference, DAT_wait 5-13
- DMA configuration structure
 - DMA_Config 6-7
 - DMA_GlobalConfig 6-8
- application programming interface (API)
 - defined D-1
 - module architecture 1-3
 - module introduction
 - module support, TMS320C6000 devices 1-15, 1-16
 - using CSL APIs, without using DSP/BIOS A-2
- architecture, chip support library 1-2
- assembler, defined D-1
- assert, defined D-1

B

- big endian, defined D-1
- bit, defined D-1
- block, defined D-1
- board support library, defined D-2
- boot, defined D-2
- boot mode, defined D-2
- BSL, defined D-2
- build options dialog box, defining the target device,
 - without using DSP/BIOS A-8
- byte, defined D-2

C

- CACHE functions
 - CACHE_clean 2-6
 - CACHE_enableCaching 2-7
 - CACHE_flush 2-9
 - CACHE_getL2Mode 2-19
 - CACHE_getL2SramSize 2-10
 - CACHE_invalidate 2-10
 - CACHE_invAllL1p 2-11
 - CACHE_invL1d 2-11
 - CACHE_invL1p 2-12
 - CACHE_invL2 2-13
 - CACHE_L1D_LINESIZE 2-14
 - CACHE_L2_LINESIZE 2-15
 - CACHE_reset 2-15
 - CACHE_resetEMIFA 2-15
 - CACHE_resetEMIFB 2-15
 - CACHE_resetL2Queue 2-16
 - CACHE_ROUND_TO_LINESIZE 2-16
 - CACHE_setL2Mode 2-17
 - CACHE_setL2PriReq 2-20
 - CACHE_setL2Queue 2-20
 - CACHE_setPccMode 2-21
 - CACHE_SUPPORT 2-21
 - CACHE_wait 2-21
 - CACHE_wbAllL2 2-22
 - CACHE_wbInvAllL2 2-24
 - CACHE_wbInvL1d 2-23
 - CACHE_wbInvL2 2-25
 - CACHE_wbL2 2-26
- CACHE module 2-1
 - API table 2-2
 - cache, defined D-2
 - CACHE functions 2-6
 - cache module, defined D-2
 - macros 2-4
 - overview 2-2
- cache module, cache controller, defined D-2

- CCS, defined D-2
 - central processing unit (CPU), defined D-2
 - CHIP functions
 - CHIP_getCpuld 3-5
 - CHIP_getEndian 3-5
 - CHIP_getMapMode 3-6
 - CHIP_getRevId 3-6
 - CHIP module 3-1
 - API table 3-2
 - CHIP, defined D-2
 - CHIP functions 3-4
 - CHIP module, defined D-2
 - macros 3-3
 - overview 3-2
 - chip support library, defined D-2
 - chip support library (CSL)
 - API module architecture, figure 1-3
 - API module support for 6000 devices, table 1-15, 1-16
 - API modules 1-3
 - API table 4-2
 - architecture 1-2
 - benefits 1-2
 - build options dialog box, defining the target device, without using DSP/BIOS A-8
 - compiling and linking with CSL, using Code Composer Studio, without using DSP/BIOS A-7
 - configuring the Code Composer Studio project environment, without using DSP/BIOS A-7
 - CSL, defined D-3
 - data types 1-6
 - device support library, name and symbol conventions 1-17
 - directory structure, without using DSP/BIOS A-7
 - generic CSL functions 1-7
 - generic CSL handle-based macros, table 1-11
 - generic CSL macros, table 1-10
 - generic CSL symbolic constants 1-12
 - initializing registers 1-8
 - introduction 1-2
 - macros, generic descriptions 1-9
 - module interdependencies 1-4
 - module introduction 4-2
 - modules and include files 1-3
 - naming conventions 1-5
 - overview 1-1
 - resource management 1-13
 - using CSL APIs, without using DSP/BIOS A-2
 - using CSL handles 1-13
 - using CSL without DSP/BIOS A-1
 - clock cycle, defined D-2
 - clock modes, defined D-2
 - code, defined D-3
 - Code Composer Studio
 - compiling and linking with CSL, without using DSP/BIOS A-7
 - configuring the project environment, without using DSP/BIOS A-7
 - coder-decoder, defined D-3
 - compiler, defined D-3
 - compress and expand (compand), defined D-3
 - constants, generic CSL symbolic constants 1-12
 - control register, defined D-3
 - control register file, defined D-3
 - CSL Module 4-1
 - functions 4-3
 - CSL module 4-1
 - CSL functions 4-3
 - defined D-3
- ## D
- DAT functions
 - DAT_busy 5-4
 - DAT_close 5-4
 - DAT_copy 5-5
 - DAT_copy2d 5-6
 - DAT_fill 5-8
 - DAT_open 5-10
 - DAT_setPriority 5-11
 - DAT module 5-1
 - API table 5-2
 - DAT, defined D-3
 - DAT functions 5-4
 - DAT module, defined D-3
 - macros 5-3
 - module introduction 5-2
 - DAT_wait, API reference 5-13
 - data types, CSL data types 1-6
 - device ID, defined D-3
 - digital signal processor (DSP), defined D-3
 - direct memory access (DMA)
 - defined D-3
 - source, defined D-4
 - transfer, defined D-4
 - directory structure, chip support library (CSL), without using DSP/BIOS A-7

DMA functions

- DMA_allocGlobalReg 6-14
 - DMA_autoStart 6-23
 - DMA_close 6-9
 - DMA_config 6-9
 - DMA_configArgs 6-10
 - DMA_freeGlobalReg 6-16
 - DMA_getConfig 6-26
 - DMA_getEventId 6-27
 - DMA_getGlobalReg 6-16
 - DMA_getGlobalRegAddr 6-17
 - DMA_getStatus 6-27
 - DMA_globalAlloc 6-18
 - DMA_globalConfig 6-19
 - DMA_globalConfigArgs 6-20
 - DMA_globalFree 6-22
 - DMA_globalGetConfig 6-22
 - DMA_open 6-11
 - DMA_pause 6-12
 - DMA_reset 6-12
 - DMA_restoreStatus 6-27
 - DMA_setAuxCtl 6-28
 - DMA_setGlobalReg 6-23
 - DMA_start 6-13
 - DMA_stop 6-13
 - DMA_wait 6-29
- DMA module 6-1
- API table 6-2
 - channel
 - configuration structure 6-7
 - configuration structures 6-2
 - devices with DMA 5-3
 - DMA, defined D-3
 - DMA functions 6-9
 - DMA module, defined D-4
 - introduction 6-2
 - macros 6-5
- DMA/EDMA management 5-3
- DMA_Config 6-7
- DMA_config(), example using without DSP/
BIOS A-2
- DMA_configArgs(), example using without using
DSP/BIOS A-5
- DMA_GlobalConfig 6-8

E

EDMA configuration structure, EDMA_Config 7-7

EDMA functions

- EDMA_allocTable 7-16
 - EDMA_allocTableEx 7-17
 - EDMA_chain 7-18
 - EDMA_clearChannel 7-19
 - EDMA_clearPram 7-20
 - EDMA_close 7-8
 - EDMA_config 7-8
 - EDMA_configArgs 7-9
 - EDMA_disableChaining 7-20
 - EDMA_disableChannel 7-21
 - EDMA_enableChaining 7-20
 - EDMA_enableChannel 7-21
 - EDMA_freeTable 7-22
 - EDMA_freeTableEx 7-22
 - EDMA_getChannel 7-23
 - EDMA_getConfig 7-23
 - EDMA_getPriQStatus 7-24
 - EDMA_getScratchAddr 7-24
 - EDMA_getScratchSize 7-24
 - EDMA_getTableAddress 7-25
 - EDMA_intAlloc 7-25
 - EDMA_intClear 7-25
 - EDMA_intDefaultHandler 7-26
 - EDMA_intDisable 7-26
 - EDMA_intDispatcher 7-26
 - EDMA_intEnable 7-27
 - EDMA_intFree 7-27
 - EDMA_intHook 7-28
 - EDMA_intTest 7-29
 - EDMA_link 7-29
 - EDMA_open 7-10
 - EDMA_qdmaConfig 7-30
 - EDMA_qdmaConfigArgs 7-31
 - EDMA_reset 7-15
 - EDMA_resetAll 7-32
 - EDMA_resetPriQLength 7-32
 - EDMA_setChannel 7-32
 - EDMA_setEvtPolarity 7-33
 - EDMA_setPriQLength 7-33
- EDMA module 7-1
- API table 7-2
 - configuration structure 7-2, 7-7
 - defined D-4
 - devices with EDMA 5-3
 - EDMA, defined D-4
 - EDMA functions 7-8

- introduction, using an EDMA channel 7-4
- macros 7-5
- module introduction 7-2
- EDMA_Config 7-7
- EMAC Module 8-1
 - APIs 8-2
 - Configuration structure 8-2, 8-6
- EMIF configuration structure, EMIF_Config 9-5
- EMIF functions
 - EMIF_config 9-6
 - EMIF_configArgs 9-7
 - EMIF_getConfig 9-8
- EMIF module 9-1
 - API table 9-2
 - configuration structure 9-2, 9-5
 - EMIF, defined D-4
 - EMIF functions 9-6
 - EMIF module, defined D-4
 - introduction 9-2
 - macros 9-3
- EMIF_Config 9-5
- EMIFA module 10-1
- EMIFA/B configuration structure
 - EMIFA_Config 10-5
 - EMIFB_Config 10-5
- EMIFA/B functions
 - EMIFA_config 10-7
 - EMIFA_configArgs 10-9
 - EMIFA_getConfig 10-11
 - EMIFB_config 10-7
 - EMIFB_configArgs 10-9
 - EMIFB_getConfig 10-11
- EMIFA/B module
 - configuration structure 10-5
 - EMIFA/B functions 10-7
- EMIFA/EMIFB modules
 - API table 10-2
 - configuration structure 10-2
 - introduction 10-2
 - macros 10-3
- EMIFA_Config 10-5
- EMIFB module 10-1
- EMIFB_Config 10-5
- endianess, chip support library 1-17
- evaluation module, defined D-4
- external interrupt, defined D-4
- external memory interface (EMIF), defined D-4

F

- fetch packet, defined D-4
- flag, defined D-4
- frame, defined D-5
- functions, generic CSL functions 1-7

G

- GIE bit, defined D-5
- GPIO configuration structure, GPIO_Config 11-7
- GPIO functions
 - GPIO_clear 11-11
 - GPIO_close 11-8
 - GPIO_config 11-8
 - GPIO_configArgs 11-9
 - GPIO_deltaHighClear 11-12
 - GPIO_deltaHighGet 11-13
 - GPIO_deltaLowClear 11-11
 - GPIO_deltaLowGet 11-12
 - GPIO_getConfig 11-13
 - GPIO_intPolarity 11-14
 - GPIO_maskHighClear 11-16
 - GPIO_maskHighSet 11-16
 - GPIO_maskLowClear 11-15
 - GPIO_maskLowSet 11-15
 - GPIO_open 11-10
 - GPIO_pinDirection 11-17
 - GPIO_pinDisable 11-17
 - GPIO_pinEnable 11-18
 - GPIO_pinRead 11-18
 - GPIO_pinWrite 11-19
 - GPIO_read 11-20
 - GPIO_reset 11-10
 - GPIO_write 11-20
- GPIO module 11-1
 - API table 11-2
 - configuration structure 11-2, 11-7
 - introduction 11-2
 - macros 11-5
 - module introduction, using a GPIO device 11-4
- GPIO_Config 11-7

H

- HAL macro reference 28-12
 - PER_ADDR 28-12
 - PER_ADDRH 28-12
 - PER_CRGET 28-12

- PER_CRSET 28-13
- PER_FGET 28-13
- PER_FGETA 28-14
- PER_FGETH 28-14
- PER_FMK 28-14
- PER_FMKS 28-15
- PER_FSET 28-15
- PER_FSETA 28-16
- PER_FSETH 28-16
- PER_FSETS 28-17
- PER_FSETSA 28-17
- PER_FSETSH 28-18
- PER_REG_DEFAULT 28-21
- PER_REG_FIELD_DEFAULT 28-24
- PER_REG_FIELD_OF 28-24
- PER_REG_FIELD_SYM 28-24
- PER_REG_OF 28-22
- PER_REG_RMK 28-23
- PER_RGET 28-18
- PER_RGETA 28-19
- PER_RGETH 28-19
- PER_RSET 28-20
- PER_RSETA 28-20
- PER_RSETH 28-21
- HAL macros 28-1
 - generic comments regarding HAL macros 28-6
 - generic macro notation 28-4
 - introduction 28-2
 - table 28-5
- handles, using CSL handles 1-13
- host, defined D-5
- host port interface (HPI), defined D-5
- HPI functions
 - HPI_getDspint 12-5
 - HPI_getEventId 12-5
 - HPI_getFetch 12-5
 - HPI_getHint 12-6
 - HPI_getHrdy 12-6
 - HPI_getHwob 12-6
 - HPI_getReadAddr 12-6
 - HPI_getWriteAddr 12-7
 - HPI_setDspint 12-7
 - HPI_setHint 12-7
 - HPI_setReadAddr 12-8
 - HPI_setWriteAddr 12-8
- HPI module 12-1
 - API table 12-2
 - HPI, defined D-5
 - HPI functions 12-5
 - HPI module, defined D-5
 - introduction 12-2
 - macros 12-3
- I**
- I2C configuration structure, I2C_Config 13-7
- I2C functions
 - I2C_bb 13-13
 - I2C_clear 13-8
 - I2C_config 13-8
 - I2C_configArgs 13-9, 13-10
 - I2C_getConfig 13-14
 - I2C_getEventId 13-14
 - I2C_getRcvAddr 13-15
 - I2C_getXmtAddr 13-15
 - I2C_intClear 13-16
 - I2C_intClearAll 13-16
 - I2C_intEvtDisable 13-17
 - I2C_intEvtEnable 13-18
 - I2C_open 13-10
 - I2C_OPEN_RESET 13-18
 - I2C_outOfReset 13-19
 - I2C_readByte 13-19
 - I2C_reset 13-11
 - I2C_resetAll 13-12
 - I2C_rfull 13-20
 - I2C_rrdy 13-20
 - I2C_sendStop 13-12
 - I2C_start 13-13
 - I2C_writeByte 13-21
 - I2C_xempty 13-21
 - I2C_xrdy 13-22
- I2C module 13-1
 - API table 13-2
 - configuration structure 13-7
 - configuration structures 13-2
 - I2C functions 13-8
 - introduction 13-2
 - macros 13-5
- I2C_Config 13-7
- index, defined D-5
- indirect addressing, defined D-5
- initializing a DMA channel with DMA_config(), without using DSP/BIOS A-2
- initializing a DMA channel with DMA_configArgs(), without using DSP/BIOS A-5
- initializing registers 1-8
- instruction fetch packet, defined D-5

internal interrupt, defined D-5
internal peripherals, defined D-6
interrupt, defined D-5
interrupt service fetch packet (ISFP), defined D-5
interrupt service routine (ISR), defined D-6
interrupt service table (IST), defined D-6
IRQ configuration structure, IRQ_Config 14-6
IRQ functions
 IRQ_clear 14-9
 IRQ_config 14-9
 IRQ_configArgs 14-10
 IRQ_disable 14-11
 IRQ_enable 14-11
 IRQ_getArg 14-17
 IRQ_getConfig 14-18
 IRQ_globalDisable 14-12
 IRQ_globalEnable 14-12
 IRQ_globalRestore 14-12
 IRQ_map 14-19
 IRQ_nmiDisable 14-19
 IRQ_nmiEnable 14-19
 IRQ_reset 14-13
 IRQ_resetAll 14-20
 IRQ_restore 14-13
 IRQ_set 14-20
 IRQ_setArg 14-21
 IRQ_setVecs 14-14
 IRQ_test 14-14
IRQ module 14-1
 API table 14-2
 configuration structure 14-2, 14-6
 introduction 14-2
 IRQ, defined D-6
 IRQ functions 14-9
 IRQ module, defined D-6
 macros 14-4
IRQ_Config 14-6
IST, defined D-6

L

least significant bit (LSB), defined D-6
linker, defined D-6

Index-6

little endian, defined D-6

M

m-law companding, defined D-6
macro reference, HAL macro reference 28-12
 PER_ADDR 28-12
 PER_ADDRH 28-12
 PER_CRGET 28-12
 PER_CRSET 28-13
 PER_FGET 28-13
 PER_FGETA 28-14
 PER_FGETH 28-14
 PER_FMK 28-14
 PER_FMKS 28-15
 PER_FSET 28-15
 PER_FSETA 28-16
 PER_FSETH 28-16
 PER_FSETS 28-17
 PER_FSETSA 28-17
 PER_FSETSH 28-18
 PER_REG_DEFAULT 28-21
 PER_REG_FIELD_DEFAULT 28-24
 PER_REG_FIELD_OF 28-24
 PER_REG_FIELD_SYM 28-24
 PER_REG_OF 28-22
 PER_REG_RMK 28-23
 PER_RGET 28-18
 PER_RGETA 28-19
 PER_RGETH 28-19
 PER_RSET 28-20
 PER_RSETA 28-20
 PER_RSETH 28-21
Macros, MDIO 17-3
macros
 CACHE 2-4
 CHIP 3-3
 chip support library, generic descriptions 1-9
 DAT 5-3
 DMA 6-5
 EDMA 7-5
 EMIF 9-3
 EMIFA/EMIFB 10-3
 generic CSL handle-based macros, table 1-11
 generic CSL macros, table 1-10

- GPIO 11-5
 - HPI 12-3
 - I2C 13-5
 - IRQ 14-4
 - MCASP 15-5
 - MCBSP 16-5
 - PCI 18-4
 - PLL 19-4
 - PWR 20-3
 - TCP 21-6
 - TIMER 22-4
 - UTOP
 - UTOPIA 23-4
 - VCP 24-5
- maskable interrupt, defined D-6
- McASP configuration structure
- MCASP_Config 15-7
 - MCASP_ConfigGbl 15-7
 - MCASP_ConfigRcv 15-8
 - MCASP_ConfigSrctl 15-8
 - MCASP_ConfigXmt 15-9
- McASP functions
- MCASP_close 15-10
 - MCASP_config 15-10
 - MCASP_configDit 15-18
 - MCASP_configGbl 15-18
 - MCASP_configRcv 15-19
 - MCASP_configSrctl 15-19
 - MCASP_configXmt 15-20
 - MCASP_enableClk 15-20
 - MCASP_enableFsync 15-21
 - MCASP_enableHclk 15-22
 - MCASP_enablePins 15-17
 - MCASP_enableSers 15-23
 - MCASP_enableSm 15-24
 - MCASP_getConfig 15-25
 - MCASP_getGblctl 15-25
 - MCASP_getRcvEventId 15-30
 - MCASP_getXmtEventId 15-31
 - MCASP_open 15-11
 - MCASP_read32 15-12
 - MCASP_read32Cfg 15-26
 - MCASP_reset 15-12
 - MCASP_resetRcv 15-26
 - MCASP_resetXmt 15-27
 - MCASP_setPins 15-27
 - MCASP_setupClk 15-28
 - MCASP_setupFormat 15-28
 - MCASP_setupFsync 15-29
 - MCASP_write32 15-13
 - MCASP_write32Cfg 15-30
- McASP module 15-1
- API table 15-2
 - configuration structures 15-2
 - introduction 15-2
 - macros 15-5
- MCASP_Config 15-7
- MCASP_ConfigGbl 15-7
- MCASP_ConfigRcv 15-8
- MCASP_ConfigSrctl 15-8
- MCASP_ConfigXmt 15-9
- MCASP_SetupClk 15-14
- MCASP_SetupFormat 15-15
- MCASP_SetupFsync 15-16
- MCASP_SetupHclk 15-16
- MCASP_SUPPORT 15-17
- McBSP configuration structure, MCBSP_Config 16-7
- McBSP functions
- MCBSP_close 16-9
 - MCBSP_config 16-9
 - MCBSP_configArgs 16-11
 - MCBSP_enableFsync 16-15
 - MCBSP_enableRcv 16-15
 - MCBSP_enableSrg 16-16
 - MCBSP_enableXmt 16-16
 - MCBSP_getConfig 16-16
 - MCBSP_getPins 16-17
 - MCBSP_getRcvAddr 16-17
 - MCBSP_getRcvEventId 16-23
 - MCBSP_getXmtAddr 16-18
 - MCBSP_getXmtEventId 16-24
 - MCBSP_open 16-13
 - MCBSP_read 16-18
 - MCBSP_reset 16-19
 - MCBSP_resetAll 16-19
 - MCBSP_rfull 16-19
 - MCBSP_rrdy 16-20
 - MCBSP_rsyncerr 16-20
 - MCBSP_setPins 16-21
 - MCBSP_start 16-14
 - MCBSP_write 16-22
 - MCBSP_xempty 16-22
 - MCBSP_xrdy 16-22
 - MCBSP_xsyncerr 16-23
- McBSP module
- configuration structure 16-7

- macros 16-5
- MCBSP, defined D-6
- MCBSP module, defined D-6
- McASP module
 - configuration structure 15-7
 - functions 15-10
- McBSP module 16-1
 - API table 16-2
 - configuration structure 16-2
 - functions 16-9
 - introduction 16-2
- MCBSP_Config 16-7
- MDIO functions
 - MDIO_close 17-4
 - MDIO_getStatus 17-4
 - MDIO_initPHY 17-5
 - MDIO_open 17-5
 - MDIO_phyRegRead 17-6
 - MDIO_phyRegWrite 17-6
 - MDIO_SUPPORT 17-7
 - MDIO_timerTick 17-7
- MDIO module 17-1
- memory map, defined D-6
- memory-mapped register, defined D-7
- most significant bit (MSB), defined D-7
- multichannel buffered serial port (McBSP), defined D-7
- multiplexer, defined D-7

N

- naming conventions, chip support library 1-5
- nonmaskable interrupt (NMI), defined D-7

O

- object file, defined D-7
- off chip, defined D-7
- on chip, defined D-7

P

- PCI configuration structure, PCI_ConfigXfr 18-6
- PCI functions
 - PCI_curByteCntGet 18-7
 - PCI_curDSPAddrGet 18-7
 - PCI_curPciAddrGet 18-7

- PCI_dspIntReqClear 18-8
- PCI_dspIntReqSet 18-8
- PCI_eepromErase 18-8
- PCI_eepromEraseAll 18-9
- PCI_eepromIlsAutoCfg 18-9
- PCI_eepromRead 18-9
- PCI_eepromSize 18-10
- PCI_eepromTest 18-10
- PCI_eepromWrite 18-10
- PCI_eepromWriteAll 18-11
- PCI_intClear 18-11
- PCI_intDisable 18-12
- PCI_intEnable 18-12
- PCI_intTest 18-12
- PCI_pwrStatTest 18-13
- PCI_pwrStatUpdate 18-13
- PCI_xfrByteCntSet 18-14
- PCI_xfrConfig 18-14
- PCI_xfrConfigArgs 18-15
- PCI_xfrEnable 18-15
- PCI_xfrFlush 18-16
- PCI_xfrGetConfig 18-16
- PCI_xfrHalt 18-16
- PCI_xfrStart 18-17
- PCI_xfrTest 18-17
- PCI module 18-1
 - API table 18-2
 - configuration structure 18-2, 18-6
 - introduction 18-2
 - macros 18-4
 - PCI, defined D-7
 - PCI functions 18-7
 - PCI module, defined D-7
- PCI_ConfigXfr 18-6
- PER_Config, example using 1-8
- PER_config(), example using 1-8
- PER_configArgs, example using 1-8
- peripheral, defined D-7
- PLL functions
 - PLL_bypass 19-7
 - PLL_clkTest 19-7
 - PLL_config 19-8
 - PLL_configArgs 19-8
 - PLL_deassert 19-9
 - PLL_disableOscDiv 19-9
 - PLL_disablePIIDiv 19-9
 - PLL_enable 19-10
 - PLL_enableOscDiv 19-10
 - PLL_enablePIIDiv 19-11
 - PLL_getConfig 19-11

- PLL_getMultiplier 19-11
- PLL_getOscRatio 19-12
- PLL_getPIIRatio 19-12
- PLL_init 19-12
- PLL_operational 19-13
- PLL_pwrdown 19-13
- PLL_reset 19-14
- PLL_setMultiplier 19-14
- PLL_setOscRatio 19-14
- PLL_setPIIRatio 19-15
- PLL module 19-1
 - API table 19-2
 - configuration structure 19-2
 - introduction 19-2
 - macros 19-4
 - PLL functions 19-7
 - PLL structures 19-6
- PLL structures, PLL_Config 19-6
- PLL_Config 19-6
- program cache, defined D-7
- program memory, defined D-7
- protocol-to-program peripherals 1-2
- PWR configuration structure, PWR_Config 20-5
- PWR functions
 - PWR_config 20-6
 - PWR_configArgs 20-6
 - PWR_getConfig 20-7
 - PWR_powerDown 20-7
- PWR module 20-1
 - API table 20-2
 - configuration structure 20-2, 20-5
 - introduction 20-2
 - macros 20-3
 - PWR, defined D-7
 - PWR functions 20-6
 - PWR module, defined D-7
- PWR_Config 20-5

R

- random-access memory (RAM), defined D-8
- reduced-instruction-set computer (RISC), defined D-8
- register, defined D-8

- registers
 - CACHE B-2
 - DMA B-17
 - EDMA B-31
 - EMAC control module B-60
 - EMAC module B-64
 - EMIF B-122
 - GPIO B-149
 - HPI B-159
 - I2C B-168
 - initializing registers 1-8
 - IRQ B-203
 - McASP B-207
 - McBSP B-284
 - MDIO module B-311
 - PCI B-328
 - PLL B-353
 - power-down logic, power-down control register (PDCTL) B-359
 - TCP B-360
 - TIMER B-382
 - UTOPIA B-386
 - VCP B-396
 - VIC port B-409
 - video capture B-427
 - video display B-462
 - video port B-413
 - video port GPIO B-504
 - XBUS B-529
- reset, defined D-8
- resource management 1-2
 - chip support library 1-13
- RTOS, defined D-8

S

- STDINC module, defined D-8
- symbolic peripheral descriptions 1-2
- synchronous dynamic random-access memory (SDRAM), defined D-8
- synchronous-burst static random-access memory (SBSRAM), defined D-8
- syntax, defined D-8
- system software, defined D-8

T

- tag, defined D-9
- target device, defining in the build options dialog box, without using DSP/BIOS A-8

- TCP configuration structures
 - TCP_BaseParams 21-8
 - TCP_ConfigIc 21-9
 - TCP_Params 21-10
- TCP functions
 - TCP_accessErrGet 21-18
 - TCP_calcCountsSA 21-13
 - TCP_calcCountsSP 21-13
 - TCP_calcSubBlocksSA 21-13
 - TCP_calcSubBlocksSP 21-13
 - TCP_calculateHd 21-14
 - TCP_ceil 21-14
 - TCP_deinterleaveExt 21-15
 - TCP_demuxInput 21-15
 - TCP_errTest 21-16
 - TCP_genParams 21-17
 - TCP_getAprioriEndian 21-18
 - TCP_getExtEndian 21-19
 - TCP_getFrameLenErr 21-19
 - TCP_getIc 21-17
 - TCP_getIcConfig 21-19
 - TCP_getInterEndian 21-20
 - TCP_getInterleaveErr 21-20
 - TCP_getLastRelLenErr 21-21
 - TCP_getModeErr 21-21
 - TCP_getNumIt 21-22
 - TCP_getOutParmErr 21-22
 - TCP_getProlLenErr 21-22
 - TCP_getRateErr 21-23
 - TCP_getRelLenErr 21-23
 - TCP_getSubFrameErr 21-23
 - TCP_getSysParEndian 21-24
 - TCP_icConfig 21-24
 - TCP_icConfigArgs 21-25
 - TCP_interleaveExt 21-26
 - TCP_makeTailArgs 21-27
 - TCP_normalCeil 21-28
 - TCP_pause 21-28
 - TCP_setAprioriEndian 21-29
 - TCP_setExtEndian 21-30
 - TCP_setInterEndian 21-30
 - TCP_setNativeEndian 21-31
 - TCP_setPacked32Endian 21-31
 - TCP_setParams 21-31
 - TCP_setSysParEndian 21-32
 - TCP_start 21-33
 - TCP_statError 21-33
 - TCP_statPause 21-33
 - TCP_statRun 21-34
 - TCP_statWaitApriori 21-34
 - TCP_statWaitExt 21-34
 - TCP_statWaitHardDec 21-35
 - TCP_statWaitIc 21-35
 - TCP_statWaitInter 21-35
 - TCP_statWaitOutParm 21-36
 - TCP_statWaitSysPar 21-36
 - TCP_tailConfig 21-37
 - TCP_tailConfig3GPP 21-38
 - TCP_tailConfigIs2000 21-39
 - TCP_unpause 21-40
- TCP module 21-1
 - API table 21-2
 - configuration structures 21-8
 - introduction 21-2
 - macros 21-6
 - module introduction, using a TCP device 21-5
 - TCP functions 21-13
- TCP_BaseParams 21-8
- TCP_ConfigIc 21-9
- TCP_Params 21-10
- timer, defined D-9
- TIMER configuration structure, TIMER_Config 22-6
- TIMER functions
 - TIMER_close 22-7
 - TIMER_config 22-7
 - TIMER_configArgs 22-8
 - TIMER_getConfig 22-11
 - TIMER_getCount 22-11
 - TIMER_getDatIn 22-12
 - TIMER_getEventId 22-12
 - TIMER_getPeriod 22-12
 - TIMER_getTstat 22-13
 - TIMER_open 22-9
 - TIMER_pause 22-9
 - TIMER_reset 22-10
 - TIMER_resetAll 22-13
 - TIMER_resume 22-10
 - TIMER_setCount 22-13
 - TIMER setDataOut 22-14
 - TIMER_setPeriod 22-14
 - TIMER_start 22-10
- TIMER module 22-1
 - API table 22-2
 - configuration structure 22-2, 22-6
 - defined D-9
 - functions 22-7
 - introduction 22-2

- macros 22-4
- module introduction, using a TIMER device 22-3
- TIMER_Config 22-6

U

- UTOP_Config 23-6
- UTOPIA configuration structure, UTOPIA_Config 23-6
- UTOPIA functions
 - UTOP_config 23-7
 - UTOP_configArgs 23-7
 - UTOP_enableRcv 23-8
 - UTOP_enableXmt 23-8
 - UTOP_errClear 23-8
 - UTOP_errDisable 23-9
 - UTOP_errEnable 23-9
 - UTOP_errReset 23-10
 - UTOP_errTest 23-10
 - UTOP_getConfig 23-11
 - UTOP_getEventId 23-11
 - UTOP_getRcvAddr 23-11
 - UTOP_getXmtAddr 23-12
 - UTOP_intClear 23-12
 - UTOP_intDisable 23-12
 - UTOP_intEnable 23-13
 - UTOP_intReset 23-13
 - UTOP_intTest 23-14
 - UTOP_read 23-14
 - UTOP_write 23-15
- UTOPIA module 23-1
 - API table 23-2
 - configuration structure 23-2, 23-6
 - functions 23-7
 - macros 23-4
 - module introduction 23-2

V

- VCP, defined D-9
- VCP configuration structures
 - VCP_BaseParams 24-7
 - VCP_ConfigIc 24-8
 - VCP_Params 24-9
 - VCP_statRun 24-23
- VCP functions
 - VCP_ceil 24-11

- VCP_errTest 24-12
- VCP_genIc 24-12
- VCP_genParams 24-13
- VCP_getBmEndian 24-14
- VCP_getIcConfig 24-14
- VCP_getMaxSm 24-15
- VCP_getMinSm 24-15
- VCP_getNumInFifo 24-15
- VCP_getNumOutFifo 24-16
- VCP_getSdEndian 24-16
- VCP_getYamBit 24-16
- VCP_icConfig 24-17
- VCP_icConfigArgs 24-18
- VCP_normalCeil 24-18
- VCP_pause 24-19
- VCP_reset 24-19
- VCP_setBmEndian 24-20
- VCP_setNativeEndian 24-20
- VCP_setPacked32Endian 24-21
- VCP_setSdEndian 24-21
- VCP_start 24-21
- VCP_statError 24-22
- VCP_statInFifo 24-22
- VCP_statOutFifo 24-22
- VCP_statPause 24-23
- VCP_statSymProc 24-23
- VCP_statWaitIc 24-24
- VCP_stop 24-24
- VCP_unpause 24-25
- VCP module 24-1
 - API table 24-2
 - configuration structure 24-7
 - configuration structures 24-2
 - functions 24-11
 - introduction 24-2
 - macros 24-5
 - module introduction, using the VCP 24-4
- VCP_BaseParams 24-7
- VCP_ConfigIc 24-8
- VCP_Params 24-9
- VIC, defined D-9
- VIC functions
 - VIC_getClkDivider 25-5
 - VIC_getGo 25-4
 - VIC_getInputBits 25-5
 - VIC_getPrecision 25-4
 - VIC_setClkDivider 25-7
 - VIC_setGo 25-6
 - VIC_setInputBits 25-7
 - VIC_setPrecision 25-6

- VIC module 25-1
 - Functions 25-2
 - Macros 25-3
 - Overview 25-2
- video port, operating mode selection B-416
- VP, defined D-9
- VP functions 26-9
- VP module 26-1
 - configuration structures
 - functions 26-2
 - macros 26-2
 - overview 26-2

W

- word, defined D-9

X

- XBUS module, defined D-9
- XBUS module 27-1
 - APIs 27-2
 - configuration structure 27-2
 - functions 27-5
 - macros 27-2
 - overview 27-2